

Technical Manual



**Disponible
en Español**
Visite ricelake.com/spanish
para ver todos los materiales
RLWS disponibles en Español

© Rice Lake Weighing Systems. All rights reserved.

Rice Lake Weighing Systems® is a registered trademark of
Rice Lake Weighing Systems.

All other brand or product names within this publication are trademarks or
registered trademarks of their respective companies.

All information contained within this publication is, to the best of our knowledge, complete and
accurate at the time of publication. Rice Lake Weighing Systems reserves the right to make
changes to the technology, features, specifications and design of the equipment without notice.

The most current version of this publication, software, firmware and all other product
updates can be found on our website:

www.ricelake.com

Revision History

This section tracks and describes the current and previous manual revisions for awareness of major updates and when the updates took place.

Revision	Date	Description
H	September 17, 2019	Revision history established after Rev H
I	June 09, 2022	Added UKCA certification
J	October 4, 2022	Added UL statements

Table i. Revision Letter History



Technical training seminars are available through Rice Lake Weighing Systems. Course descriptions and dates can be viewed at www.ricelake.com/training or obtained by calling 715-234-9171 and asking for the training department.

1.0	Introduction	1
1.1	Safety	1
1.2	Overview	2
1.2.1	Enclosures	2
1.2.2	Interface Board	2
1.2.3	LED Backlight	2
1.3	Features	2
1.4	Options	4
1.4.1	Option Cards	4
1.4.2	Expansion Boards	4
1.4.3	Relay Options	5
1.4.4	DC Power Supplies	5
1.4.5	Outdoor Display	5
2.0	Operation	6
2.1	Front Panel	6
2.2	Operating Modes	7
2.3	Indicator Operations	7
2.3.1	Gross/Net Mode	7
2.3.2	Units	7
2.3.3	Zero Scale	7
2.3.4	Acquire Tare	7
2.3.5	Keyed Tare (Preset Tare)	7
2.3.6	Remove Stored Tare Value	7
2.3.7	Print Ticket	7
2.4	Accumulator Functions	8
2.5	Softkey Operations	8
2.6	USB Functions	9
2.7	Contrast Adjustment	9
2.8	Hardware and Firmware Compatibility	9
3.0	Installation	10
3.1	Unpacking	10
3.2	Enclosure	10
3.2.1	Remove Back Plate	10
3.2.2	Install Back Plate	10
3.3	Cable Connections	11
3.3.1	Cable Specifications	11
3.3.2	Sealed USB Connectors – Optional	11
3.3.3	Load Cells	13
3.3.4	Serial Communications	14
3.3.5	USB Communications (Port 2)	15
3.3.6	Keyboard Interface	16
3.3.7	Digital I/O	17
3.4	Ground Cables/Wires	18
3.4.1	Stripping Cables	18
3.5	Installing Option Cards	19
3.6	Sealing the Front Door	20
3.7	Expansion Board Configurations	21
3.7.1	Expansion Board Serial Port Assignments	22
3.8	CPU Board Removal	23



Rice Lake continually offers web-based video training on a growing selection of product-related topics at no cost. Visit www.ricelake.com/webinars

Contents

3.9	Battery Replacement	23
3.9.1	Replacement	23
3.10	Parts Kit	24
3.10.1	LED Backlight	24
3.11	Replacement Parts Illustrations	25
4.0	Configuration	27
4.1	iRev™ Configuration	27
4.2	Serial Command Configuration	27
4.3	Configuration Switch	27
4.4	Front Panel Configuration	28
4.5	Main Menu	29
4.6	Scales Menu	30
4.6.1	Digital Filtering	33
4.6.2	Format Menu	35
4.6.3	Unit Conversion Factors	37
4.6.4	Calibration Menu	39
4.7	Serial Menu	39
4.7.1	Ports	39
4.7.2	Port 1	40
4.7.3	Port 2 with Serial Interface Option	40
4.7.4	Port 2 with USB Interface Option	41
4.7.5	Port 3 and 4 Menu Structure	42
4.7.6	RS-485 Port Parameters	43
4.7.7	Local/Remote Operation	44
4.7.8	Custom Stream Formatting	44
4.8	Feature Menu	46
4.8.1	Contact Menu	48
4.8.2	Regulatory/Industrial Menu	49
4.8.3	Regulatory Mode Functions	50
4.9	Print Format Menu	51
4.10	Setpoints Menu	52
4.11	Digital I/O Menu	53
4.12	Analog Output Menu	55
4.13	Fieldbus Menu	56
4.14	Version Menu	56
5.0	Calibration	57
5.1	Gravity Compensation	57
5.2	Front Panel Calibration	57
5.2.1	Five-Point Linearization (WLIN)	59
5.2.2	Rezero Parameter	59
5.3	Serial Command Calibration	60
5.4	iRev Calibration	61
6.0	iRev	62
6.1	Install iRev Program	62
6.2	Open iRev	62
6.3	Saving and Opening Files	63
6.4	Hardware Configuration	63



Technical training seminars are available through Rice Lake Weighing Systems. Course descriptions and dates can be viewed at www.ricelake.com/training or obtained by calling 715-234-9171 and asking for the training department.

6.5	Configuring Scales	64
6.5.1	Configuring Other Parameters	65
6.5.2	Setpoints	65
6.6	Configuring the Display	67
6.7	Connecting to the Indicator	67
6.7.1	Download to Indicator	68
6.7.2	Upload Configuration to iRev	68
6.8	Installing Firmware Upgrades	68
7.0	USB Devices	70
7.1	USB Driver Installation	70
7.2	Connecting a USB Device	71
7.3	Using USB Hubs	71
7.4	Disconnecting a USB Device	71
7.5	Loading Configuration Files and Databases	71
7.5.1	Loading Configuration Files	72
7.5.2	Loading Database Files	72
7.6	Saving Configuration Files and Databases	73
7.7	Loading New Firmware	74
8.0	Print Format	75
8.1	Print Formatting Commands	75
8.1.1	General Weight Data Commands	75
8.1.2	Accumulator Commands	76
8.1.3	Truck Mode Commands	76
8.1.4	Setpoint Commands	76
8.1.5	Auditing Commands	76
8.1.6	Formatting and General-Purpose Commands	77
8.1.7	User Program-Dependent Commands	77
8.1.8	Alert Format Commands	77
8.2	LaserLight Commands	78
8.3	Default Print Formats	78
8.4	Customizing Print Formats	79
8.4.1	Using iRev	79
8.4.2	Using the Front Panel	79
8.4.3	Using Serial Commands	81
9.0	Truck Modes	82
9.1	Using the Truck Modes	82
9.2	Using the Truck Regs Display	83
9.3	Weigh-In Procedure	83
9.4	Weigh-Out Procedure	84
9.5	Single-Transaction Tare Weights and IDs	84
10.0	Setpoints	85
10.1	Batch and Continuous Setpoints	85
10.2	Setpoint Menu Parameters	87
10.3	Batch Operations	98
10.4	Batching Examples	101
11.0	Serial Commands	103
11.1	The Serial Command Set	103



Rice Lake continually offers web-based video training on a growing selection of product-related topics at no cost. Visit www.ricelake.com/webinars

Contents

11.1.1	Key Press Commands	103
11.1.2	USB Commands	104
11.1.3	Reporting Commands	104
11.1.4	Clear and Reset Commands	104
11.1.5	Parameter Setting Commands	105
11.1.6	Normal Mode Commands	113
11.1.7	Batching Control Commands	113
11.1.8	Database Commands	114
11.2	Widget Programming	116
11.2.1	Scale Widgets	117
11.2.2	Bitmap Widgets	117
11.2.3	Bargraph Widgets	118
11.2.4	Label Widgets	119
11.2.5	Numeric Widgets	120
11.2.6	Symbol Widgets	121
12.0	Maintenance/Troubleshooting	124
12.1	Troubleshooting	124
12.1.1	Option Card Diagnostic Errors	125
12.1.2	Using the HARDWARE Command	125
12.1.3	User Program Diagnostic Errors	126
12.1.4	Using the XE Serial Command	127
13.0	Appendix	128
13.1	Total Scale Configuration	128
13.2	Serial Scale Interface	128
13.3	Stream Formatting Examples	130
13.3.1	Toledo 8142 Indicator	130
13.3.2	Cardinal 738 Indicator	131
13.3.3	Weightronix WI -120 Indicator	131
13.4	Data Formats	132
13.5	Audit Trail Support	133
13.5.1	Displaying Audit Trail Information	133
13.5.2	Printing Audit Trail Information	133
14.0	Compliance	134
15.0	Specifications	136
15.1	Dimension Drawings	137
15.2	Printed Information	139



Technical training seminars are available through Rice Lake Weighing Systems. Course descriptions and dates can be viewed at www.ricelake.com/training or obtained by calling 715-234-9171 and asking for the training department.



Rice Lake continually offers web-based video training on a growing selection of product-related topics at no cost. Visit www.ricelake.com/webinars

1.0 Introduction

This manual is intended for use by service technicians responsible for installing and servicing the 920i Programmable Indicator/Controller. This manual applies to Version 5+ of the 920i software, which is compatible with both the serial interface and USB hardware versions of the indicator.



Manuals and additional resources are available from Rice Lake Weighing Systems at www.ricelake.com/manuals

Warranty information can be found at www.ricelake.com/warranties

1.1 Safety

Safety Definitions:



DANGER: Indicates an imminently hazardous situation that, if not avoided, will result in death or serious injury. Includes hazards that are exposed when guards are removed.



WARNING: Indicates a potentially hazardous situation that, if not avoided could result in serious injury or death. Includes hazards that are exposed when guards are removed.



CAUTION: Indicates a potentially hazardous situation that, if not avoided, could result in minor or moderate injury.



IMPORTANT: Indicates information about procedures that, if not observed, could result in damage to equipment or corruption to and loss of data.

General Safety



Do not operate or work on this equipment unless this manual has been read and all instructions are understood. Contact any Rice Lake Weighing Systems dealer for replacement manuals.



WARNING

Failure to heed may result in serious injury or death.



CAUTION:

Some procedures described in this manual require work inside the indicator enclosure. These procedures are to be performed by qualified service personnel only.

Do not allow minors (children) or inexperienced persons to operate this unit.

Do not operate if the enclosure is not completely assembled.

Do not use for purposes other than weight taking.

Do not place fingers into slots or possible pinch points.

Do not use this product if any of the components are cracked.

Do not exceed the rated specification of the unit.

Do not make alterations or modifications to the unit.

Do not remove or obscure warning labels.

Do not submerge.

Before opening the enclosure, ensure the power cord is disconnected from the power source.

Socket-outlet shall be installed near the equipment and shall be easily accessible.

Fuses must only be replaced by service personnel.

1.2 Overview

The 920i is a programmable, multi-channel digital weight indicator/controller. The configuration can be performed using:

- Front panel
- An attached USB-type keyboard (or PS/2 keyboard, if using a serial interface)
- iRev 5 utility

Custom event-driven programs can be written with the iRite[®] language up to 512 K in program size. These programs are compiled with an iRite compiler utility, which can only be downloaded to the indicator. The Rice Lake Weighing Systems Web Update Utility can be used to download firmware upgrades to a PC from the Rice Lake Weighing Systems website; iRev 5 provides functions for installing the new software into the 920i.

1.2.1 Enclosures

The 920i is available in four enclosures: universal enclosure with tilt-stand, deep enclosure, panel mount enclosure and a wall mount enclosure. Stainless steel enclosures are rated for NEMA Type 4X/IP66. This manual provides assembly drawings and replacement part lists for the universal model; supplemental documentation provides information specific to the panel mount and wall mount models.

1.2.2 Interface Board



NOTE: Choice of interface board (serial or USB) determines the menu structure of Port 2.

USB Interface Card

Onboard USB support for a host PC and the following devices:

- One flash drive
- Two printers
- And/or one keyboard (connecting more than one device requires a USB hub)

The USB interface card applies only to Port 2.

Serial Interface Card

External DB-9 and DIN-8 connectors for serial connection to a PC and attachment of PS/2 remote keyboard (cannot be used with the USB card).

1.2.3 LED Backlight

The 920i display is now shipped with an improved LED backlight, replacing the CCFL (Fluorescent) backlight. The improved LED backlight is compatible with all older CPU boards (green solder mask), however, a new power supply cable is required.

For the new blue CPU board (PN 180902) a retrofit cable is not required to power the LED backlight.



NOTE: The CCFL (Fluorescent) backlight is still available for purchase.

1.3 Features

- LCD display, 4.6" x 3.4"
- Selectable character sizes from 0.25"–1.2"
- 60 configurable operator prompts
- Display up to four scale channels per screen with required Legal for Trade information
- 32 scale accumulators
- Five softkeys with 10 user-defined, 14 preset functions per screen
- 10 programmable display screens
- Millivolt calibration, 5-point linearization and geographical calibration
- NEMA Type 4X/IP66 stainless steel enclosure
- Selectable A/D measurement rate up to 960/second
- 100 setpoints, 30 configurable setpoint types
- Two slots for option cards

- 1,000-ID truck register for in/out weighing
- 64 K user on-board NV RAM
- User programmable 128 K flash memory
- Re-flash memory to upgrade firmware
- Power for 16, 350 ohms load cells per A/D board
- Local-remote indicators
- Multi range/interval
- Alibi storage
- Audit trail tracking
- Peak hold
- Rate of change
- Support for A/D scale or serial scale inputs. The maximum number of scale inputs is 28; these can be combined to represent up to 32 scale configurations
- Six digital I/O channels on main board, each configurable as input or output
- Four serial ports on main board (ports 1–4) support duplex RS-232 up to 115200 bps; port 2 supports hardware handshaking and remote keyboard input, or as a UBS Type A and Type B port; ports 3 and 4 support 20 mA output, port 4 supports 2-wire RS-485 communications
- Available in 115 VAC and 230 VAC North American and European versions

USB Standard Features

- USB interface card on Port 2
- The USB card is supported on PN 109549 and PN 180902 CPU boards
- The 920i for USB interface requires firmware version 5.0 or higher

Connector Types

- Standard Type A: 920i connects to keyboard, ASCII font label ticket printers and flash drives
- Standard Type B: 920i connects to PC USB Interface Functions:
- Supports weigh mode and configuration mode functions
- Supports upload of databases and .920 configuration file
- Supports download of databases, .920 configuration file, iRite, COD file and firmware file
- Sanity checks for command errors

Flash Drives

- Supports USB 2.0
- Create sub directories by unit ID and database name
- Use the root directory for generic files

Optional Wash-Down Connectors

- Sealed receptacle
- Connectors - cables
- USB cover - flash drive and receptacle

Other Features

- Configurable print formats can be defined for up to 1000 characters each; these formats are used to print gross or net weights, truck in/out weights, setpoint weights, accumulator weights, alert messages and header information; additional print formats can be created with iRite
- Six truck modes to store and recall weights for gross, tare, and net printing; the truck register contains fields for ID number, weight, and the transaction time and date; weights can be stored permanently or erased at the end of the transaction
- The setpoint engine supports 31 configurable setpoint kinds; setpoints can be arranged in a sequential batch routine of up to 100 steps; if setpoints are configured as free running setpoints, the setpoints can be tied to program control; this allows for simultaneous batching operations to be written with the iRite language

1.4 Options

The CPU board provides two slots for installing A/D or other option cards. Additional option cards can be added using either two-card or six-card expansion boards connected to the CPU board via the expansion bus. Available option cards include:

Communication Protocol Cards

EtherNet/IP, DeviceNet, Profibus, Profinet, ControlNet, and Remote I/O cards must be installed in an onboard slot. They must not be installed on an expansion card.

1.4.1 Option Cards

Any of the listed option cards can be installed in Slot 2 of the CPU board or in any available slot of an attached expansion board.

Option Card	Part No.
A/D Single Channel	68532
A/D Dual Channel	68533
Analog Output Single Channel 0–10 V and 0–20 mA	67602
Analog Output Dual Channel, 0–10 V and 0–20 mA	103138
Serial Port Dual Channel Full Duplex RS232 and 4 Wire RS485	67604
I/O 24 Channel	67601
Memory Module 1 Meg	67600
Pulse Counter 12 VDC Supply	67603
Ethernet TCP/IP Interface Card, Embedded Device Server 10/100baseT	71986
EtherNet/IP, Protocol for Allen-Bradley PLC.	87803
DeviceNet™ Interface	68541
Allen-Bradley® Remote I/O Interface	68539
PROFIBUS® DP Interface	68540
ControlNet Right Angle BNC Connector	103136
PROFINET® Interface	187816
Converter, Ethernet Thin Server UDS-1100, 10/100 RJ45 232 Serial to Ethernet	65383
Ethernet Wireless Embedded Device Server 10/100 base-T	98057
Dual Analog input 0-10V 0-20mA With Dual Thermocouple Inputs; requires 2.05 software or higher	87697

Table 1-1. 920i Option Cards

1.4.2 Expansion Boards

Table 1-2 lists the expansion boards available for the panel mount and wall mount enclosures. The panel mount enclosure can accommodate a single 2-card expansion board; the wall mount enclosure supports either a 2-card or a 6-card expansion board. Any of the available option cards can be installed in any available expansion board slot.

A second 2- or 6-card expansion board can also be connected to the 920i, providing up to 14 option card slots. Consult factory for details. See Section 3.7 on page 21 for detailed information about slot and serial port assignments for expanded system configurations.

Expansion Board	Part No.
2-card expansion board for panel mount enclosure, slots 3–4, 1nc 2", 34-pin ribbon cable and power supply cable	71743
2-card expansion board for wall mount enclosure, DC powered	179488
2-card expansion board for deep universal and panel mount, DC powered	180047
2-card expansion board for wall mount enclosure, slots 3–4, 1nc 24", 34-pin ribbon cable and power supply cable	69782
6-card expansion board for wall mount enclosure, slots 3–8, 1nc 16", 34-pin ribbon cable and power supply cable	69783

Table 1-2. Part Numbers for 920i Expansion Boards



NOTE: See Section 3.7 on page 21 for detailed information about expansion board configurations.

1.4.3 Relay Options

8-, 16-, and 24-channel relay racks are available for all 920i systems. Relays can be installed internally in the wall mount enclosure; all other models require an external enclosure for the relays. Consult factory for details.

1.4.4 DC Power Supplies

Two DC power supplies are available for mobile 920i applications:

PN 97474, 12-24 VDC supply

PN 99480, 10–60 VDC supply

Consult factory for more information.

1.4.5 Outdoor Display

Optional outdoor displays that are available for use of the 920i in bright, sunlit environments:

LCD Display, Transflective, CCFL B/L (PN 164375). Not compatible with CPU PN 180902.

LCD Display, Transflective, LED B/L (PN 186276). See [Section 3.10.1 on page 24](#) for compatibility with CPU boards.

Consult factory for more information.

2.0 Operation

2.1 Front Panel

Weight information is displayed with a graphical scale in six font sizes up to 1.2". Up to four scale widgets can be displayed in Legal for Trade, multiple-scale applications. Display contrast can be adjusted with the LCD contrast potentiometer or **CONTRAST** parameter. The display can be graphically configured using iRev software.

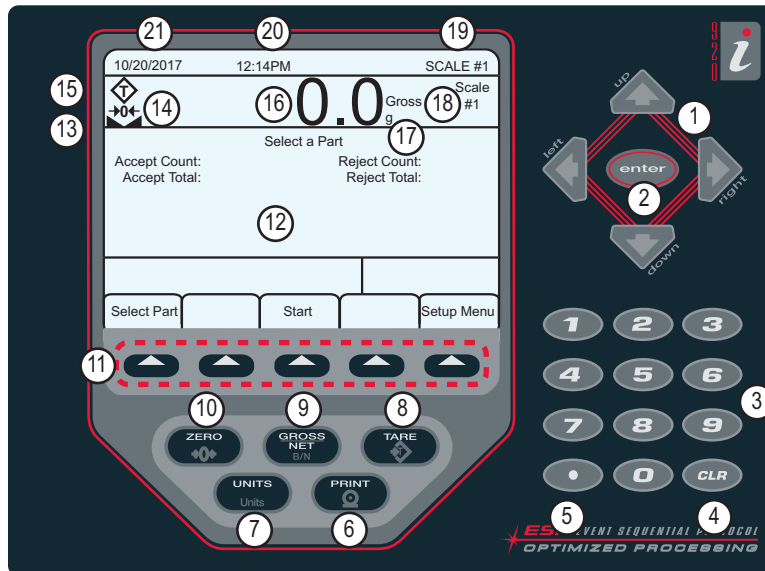

Figure 2-1. 920i Front Panel

Item No.	Descriptions
1	Navigation Keys – Used to enter values; scroll through menus
2	Enter – Save entries from the numeric keypad
3	Numeric Entry – Used for entering numbers or keyed tares
4	Clear – Backspace when entering numbers/letters
5	Decimal – Inserts a decimal point as needed
6	Print – Sends an on-demand print format out a communications port, provided the conditions for standstill are met
7	Units – Switches the weight display to an alternate unit
8	Tare – Performs a predetermined tare function as set in the TAREFN parameter; set in the Scale menu
9	Gross/Net – Toggles the weight display between gross and net mode; if a tare value has been entered or acquired, the net value is the gross weight minus the tare
10	Zero – Sets the current gross weight to zero
11	Softkeys – Keys that can be configured to provide additional operator functions
12	Display – Status areas on the display are used for operator prompts and entering data; the remainder of the display can be graphically configured for representation of a specific application
13	Standstill Symbol – Scale is at standstill or within the specified motion band
14	Center of Zero Symbol – Indicates that the current gross weight reading is within ± 0.25 display divisions of the acquired zero
15	Tare Symbol – Indicates that a tare has been acquired and stored in the system <ul style="list-style-type: none"> • T = Pushbutton tare (Section 2.3.4 on page 7) • PT = Keyed tare (Section 2.3.5 on page 7)
16	Weight Display – Current weight displays
17	Units Indicator – Current unit of display
18	Gross/Net Indicator – Indicates whether the weight value is in Net or Gross mode
19	Scale in use – Indicates the scale that is currently being read by indicator
20	Time – Displays current time
21	Date – Displays current date

Table 2-1. Key and Icon Descriptions

2.2 Operating Modes

The 920i has two modes of operation.

Weigh Mode

The indicator displays gross, net or tare weights as required, using the secondary display to indicate scale status and the type of weight value displayed. Weigh mode is the only mode in which the 920i can operate (without breaking the seal) once configuration is complete and a legal seal has been affixed the indicator.

Configuration Mode

Many of the procedures described in this manual require the indicator to be in configuration mode, including calibration ([Section 4.0 on page 27](#)).

2.3 Indicator Operations

Basic 920i operations are summarized in this section.

2.3.1 Gross/Net Mode

If a tare value has been entered or acquired, the net value is equal to gross minus the tare value.





Press  to toggle between **Gross (Brutto)** and **Net** modes. If there is no tare, the display remains in gross mode.

Annunciators at the end of the weight indicates the current mode.



2.3.2 Units

Press  to toggle between primary, secondary and tertiary units.

2.3.3 Zero Scale

1. In gross mode, remove all weight from the scale and wait for   to display.
2. Press .  **0**  displays, indicating the scale is zeroed.





2.3.4 Acquire Tare

1. Place a container on the scale and wait for   to display.
2. Press  to acquire a tare weight of the container. **0** displays with **Net**.

2.3.5 Keyed Tare (Preset Tare)

1. Enter a value from the numeric keypad.
2. Press . **Net** displays indicating the keyed tare weight is in the system.

2.3.6 Remove Stored Tare Value

1. Remove all weight from the scale and wait for   to display.
2. Press  (in OIML mode, press ). **0** displays with **Gross**.

2.3.7 Print Ticket

With   displayed, press  to send data to the serial port.

To print tickets using auxiliary formats, press the number key for the format and press **Print**.

Example: To print using AUXFMT2, press 2 on the numerical keypad then .

2.4 Accumulator Functions

The accumulator must be enabled to use in weigh mode or setpoint operations.

Weight (net if a tare is entered) is accumulated when a print operation is performed by pressing , or entering a digital input or a serial command. The scale must return to zero (net zero if a tare is entered) before the next accumulation.

The **Display Accum** softkey can be configured to display the current accumulator value. Printing while the accumulator is displayed or when the setpoint **PSHACCUM** function is enabled, uses the **ACCFMT** print format.

Press  twice to clear the accumulator.

2.5 Softkey Operations

Softkeys are defined to provide additional operator functions for specific applications. Softkey assignments are listed on the tabs shown at the bottom of the LCD display and are activated by pressing the arrow keys below the tabs.

The displayed softkeys are determined by the indicator configuration and program. Use the **FEATURE** menu to enable softkeys.

Softkey	Descriptions
Time/Date	Displays current time and date; Allows time and date change
Display Tare	Displays tare value for the current scale
Display Accum	Displays accumulator value, if enabled, for the current scale
Display ROC	Displays rate-of-change value, if enabled, for the current scale
Setpoint	Displays a menu of configured setpoints; Allows display and change of some setpoint parameters
Batch Start	Starts a configured batch
Batch Stop	Stops a running batch and turns off all associated digital outputs; Requires a batch start to resume processing
Batch Pause	Pauses a running batch; Same as stop, but digital outputs, if on, are not turned off
Batch Reset	Stops a batch and resets it to the first batch step
Weigh In	Allows truck ID entry; Generates weigh-in ticket for truck weighing applications
Weigh Out	Allows truck ID entry; Generates weigh-out ticket for truck weighing applications
Truck Regs	Displays truck register; Allows deletion of individual or all entries; Truck register can be printed by pressing the Print key while the truck register is displayed
Unit ID	Allows display or change of Unit ID
Select Scale	For multi-scale applications, provides a prompt to enter the scale number to be displayed
Diagnostics	Provides access to diagnostic displays for attached iQUBE ² junction boxes
Alibi	Allows previous print transactions to be recalled and reprinted
Contrast	Adjusts the screen contrast
Test	Future functionality
Stop	Sends AuxFmt1 out its configured port to prompt a red light on a LaserLight
Go	Sends AuxFmt2 out its configured port to prompt a green light on a LaserLight
Off	Sends AuxFmt3 out its configured port to turn a LaserLight red/green light off
Screen	Allows multiple display screens without a user program
F1-F10	User-programmable keys; Defined by application
USB	Allows the changing of USB devices (and that device's corresponding function) while in Weigh mode
More...	For applications with more than five defined softkeys, the More... softkey is automatically assigned to the fifth position; Press More... to toggle between groups of softkeys

Table 2-2. Configurable Softkeys

2.6 USB Functions

With the USB interface card installed, the 920i supports a connection to a host PC and the following devices:

- One flash drive
- Two printers
- And/or one keyboard

Connecting more than one device requires a USB hub.



NOTE: Version 5 Rev L boards (or higher) are required for USB functionality.

USB Device	Functions Supported
Host PC	Data transfer of configuration files, database files and iRite programs*
Flash Drive	Download boot monitor and core to the indicator, data transfer of configuration files, database files and iRite programs**
Printer(s)	If using more than one printer, the lowest numbered USB port on the hub will determine Printer #1
Keyboard	Inputs text and numeric characters
* Download of boot monitor and core from a PC to the indicator is not supported	
** Transfer of iRite files from 920i to flash drive is not supported	

Table 2-3. USB devices and functions

To select the target USB device to be used (Section 4.0 on page 27).

2.7 Contrast Adjustment

To adjust the contrast, use the **CONTRAST** parameter in the Features menu. Front panel adjustment can be made by assigning a softkey. This is available for CPU Board Rev H-N (PN 109549) and CPU board (PN 180902).



NOTE: When Port 2 has the Serial Interface option, there is also a potentiometer for contrast adjustment on interface card.

2.8 Hardware and Firmware Compatibility

- CPU board (PN 67612) revision A-G was the initial release and covered versions 1 and 2
Revision E-G had an increase in memory to support version 3
- CPU board (PN 109549) Rev H-N, supported iQUBE² and USB, and requires a minimum core of 3.14.00
- CPU board (PN 180902) Rev B of higher, an LED backlight, replaces the CCFL (Fluorescent) backlight

Important Information Regarding the 920i CPU Board

Beginning with Revision H, the CPU board supports only firmware 3.14 or higher. This does not affect any pre-existing user programs, contact Rice Lake Weighing Systems for performance issues.

Part No.	CPU Board Revision	Recommended Boot Monitor	Minimum Core	Maximum Core	Minimum USB Version
67612	A-D	1.00	1.00	2.08	--
	E	1.10	1.00	4.00	--
	F-G	1.12	1.00	5.XX*	--
109549	H	1.13	3.14	5.XX*	--
	L-N**	2.03	3.14	5.XX*	1.01
180902	B**	2.03	3.14	5.XX*	1.01
* Refer to current release version					
** Supports USB Interface					

Table 2-4. Hardware and Software Compatibility

3.0 Installation

This section describes procedures for connecting load cells, digital I/O and serial communications cables to the 920i. Replacement parts lists for the universal model are included for the service technician. See [Section 15.1 on page 137](#) for dimension drawings of the all the models.



WARNING: Use anti-static protection for grounding and to protect components from electrostatic discharge (ESD) when working inside the indicator enclosure. Procedures requiring work inside the indicator must be performed by qualified service personnel only.

The supply cord serves as the power disconnect for the 920i. Ensure the power cord is unplugged prior to opening the enclosure.

3.1 Unpacking

Immediately after unpacking, visually inspect the 920i to ensure all components are included and undamaged. The shipping carton contains the indicator and a parts kit. If any parts were damaged in shipment, notify Rice Lake Weighing Systems and the shipper immediately.

3.2 Enclosure

The indicator enclosure must be opened to install option cards and to connect cables for installed option cards.



WARNING: The 920i has no on/off switch. Before opening the unit, ensure the power cord is disconnected from the power supply.

3.2.1 Remove Back Plate

1. Ensure power to the indicator is disconnected.
2. Place the indicator face-down on an anti-static work mat.
3. Remove the screws that hold the backplate to the enclosure body.
4. Lift the backplate from the enclosure and set it aside.

3.2.2 Install Back Plate

1. Position the back plate over the enclosure.
2. Secure with the back plate screws.
3. Torque screws to 15 in-lb (1.7 N-m), using pattern shown in [Figure 3-1](#), to prevent distorting the back plate gasket.

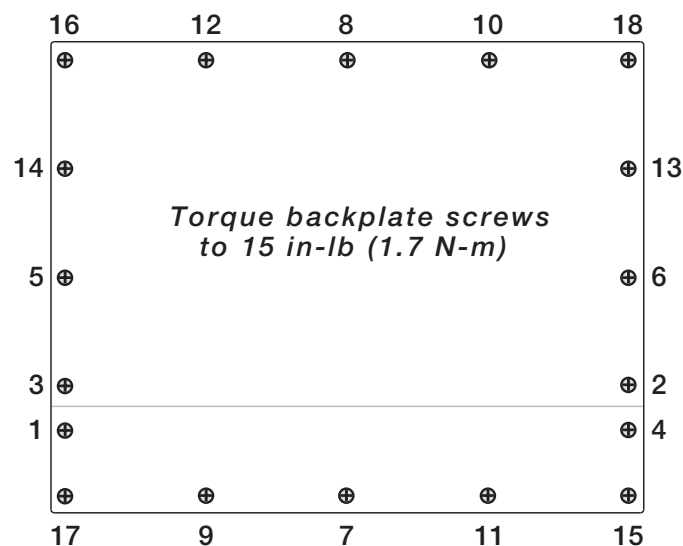

Figure 3-1. 920i Enclosure Backplate

IMPORTANT

Torqued screws may become less tight as the gasket is compressed during torque pattern, therefore a second torque is required using the same pattern and torque value.

3.3 Cable Connections

The parts kits includes cord grip plugs to prevent moisture from entering the enclosure.

Use the cable grounding instructions below for wiring into the indicator.

Install plugs in all unused cord grips to prevent moisture from entering the enclosure.

3.3.1 Cable Specifications

Cord Grip	Diameter Range
PG9 (PN 15626)	0.138 - 0.315" (3.5 - 8 mm)
PG11 (PN 68600)	0.197 - 0.394" (5 - 10 mm)

Table 3-1. Cord Grip Specifications

Connector	Torque
Around cables	22 in-lb
Cord grip to enclosure	33 in-lb

Table 3-2. Cord Grip Torque Specifications

3.3.2 Sealed USB Connectors – Optional

For wash down environments, optional sealed USB receptacles are available for use with an optional backplate (PN 119891). For optimal cable routing, it is recommended for the Type-A connector to be on the left and the Type-B connector to be on the right side.

Part No.	Descriptions
126476	Receptacle, USB Panel Mount Sealed Circular USB Type-A, with 50 cm Pigtail and Type-A End (Approximately 19.68")
124703	Receptacle, USB Panel Mount Sealed Circular USB Type-A, with 50 cm Pigtail and Type-B End
124704	Receptacle, USB Panel Mount Sealed Circular USB Type-B, with 50 cm piPigtailgtail and Type-B End
125998	Receptacle, USB Panel Mount Sealed Circular USB Type-A, with 28 cm Cable to 5-Pin Connector
125999	Receptacle, USB Panel Mount Sealed Circular USB Type-B, with 28 cm Cable to 5-Pin Connector
124689	Dust Cap, USB Flash Drive; For Use with Above Receptacles
124694	Cover; For Use with Above Receptacles

Table 3-3. Sealed USB Connectors

To install the sealed watertight USB receptacles:

1. The hole in the backplate is notched. Align the receptacle with the notches, ensuring the key on the housing is inserted in the notch.

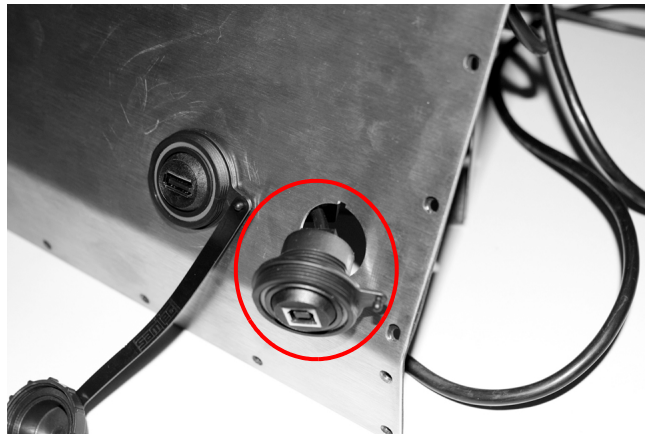

Figure 3-2. Sealed USB Receptacles on Backplate

2. Fasten the receptacle so it is flush with the backplate.
3. Connect the interface cables to the headers on the USB card.
4. Re-install the backplate ([Figure 3-1 on page 10](#)).



NOTE: Sealed cables are available to make a watertight connection.
The same type of receptacle and cables are available for Ethernet connections.

3.3.3 Load Cells

To attach the cable from a load cell or junction box to an installed A/D card, route the cable through the cord grip and ground the shield wire.

Remove connector J1 from the A/D card. The connector plugs into a header on the A/D card. Wire the load cell cable from the load cell or junction box to connector J1 (Table 3-4).

See Figure 3.4.1 on page 18 for cord grip grounding information.

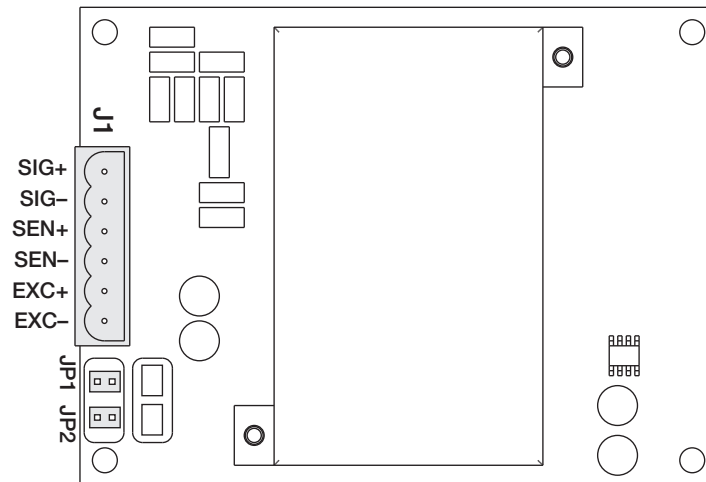

Figure 3-3. Single-Channel A/D Card

A/D Card Connector Pin	Function
1	+SIG
2	-SIG
3	+SENSE
4	-SENSE
5	+EXC
6	-EXC

Table 3-4. A/D Card Pin Assignments

If using 6-wire load cell cable (with sense wires), remove jumpers JP1 and JP2 before reinstalling connector J1.

For 4-wire installation, leave jumpers JP1 and JP2 on.

If using 6-wire load cell connections on dual-channel A/D cards, remove jumpers JP3 and JP4 for connections to J2.

When connections are complete, reinstall load cell connector on the A/D card and use two cable ties to secure the load cell cable to the inside of the enclosure.

3.3.4 Serial Communications

The four communications ports on the 920i CPU board support full duplex RS-232, 20 mA output or RS-485 communications at up to 115200 bps.

To attach serial communications cables:

1. Route the cable through the cord grip.
2. Ground the shield wire ([Section 3.4 on page 18](#)).
3. Remove the serial connector from the CPU board and wire to the connector.
4. Once cables are attached, plug the connector into the header on the board.
5. Use cable ties to secure serial cables to the inside of the enclosure.

[Table 3-5](#) indicates the pin assignments for Ports 1, 3, and 4. Port 2 provides DIN-8 and DB-9 connectors for remote keyboard attachment of PS/2-type personal computer keyboards. The DB-9 connector pin assignments for Port 2 ([Table 3-6](#)).

See [Section 3.3.6 on page 16](#) for information about the PS/2 keyboard interface.

Connector	Pin	Signal	Port
J11	1	GND	1
	2	RS-232 RxD	
	3	RS-232 TxD	
J9	1	GND / -20mA OUT	3
	2	RS-232 RxD	
	3	RS-232 TxD	
	4	+20mA OUT	
J10	1	GND / -20mA OUT	4
	2	RS-232 RxD	
	3	RS-232 TxD	
	4	+20mA OUT	
	5	RS-485 A	
	6	RS-485 B	

Table 3-5. Serial Port Pin Assignments

Serial ports are configured using the SERIAL menu. See [Section 4.7 on page 39](#) for configuration information.

An optional dual-channel serial communications expansion card, PN 67604, is available. Each serial expansion card provides two additional serial ports, including one port that supports RS-485 communications. Both ports on the expansion card can support RS-232 or 20mA connections.

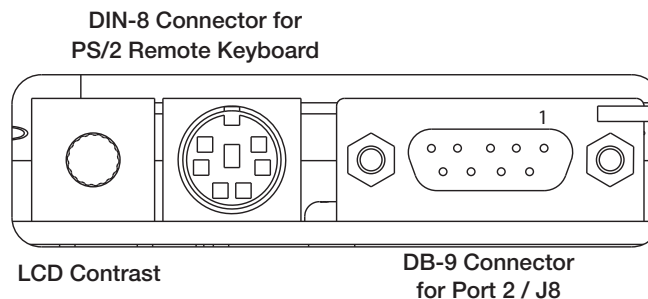

Figure 3-4. Serial Interface Board Connections

DB-9 Pin	Signal
2	TxD
3	RxD
5	GND
7	CTS
8	RTS

Table 3-6. DB-9 Connector Pin Assignments

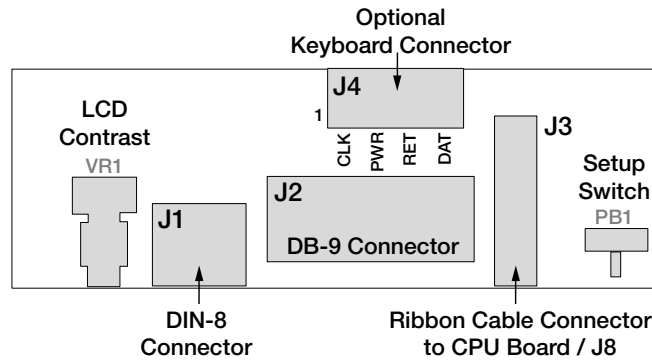

Figure 3-5. Interface Board, Top View

J4 Pin	Color	Signal
1	Brown	Clock
2	Clear	+5v
3	Yellow	GND
4	Red	Data

Table 3-7. J4 Pin Assignments (Optional Keyboard Connector)

3.3.5 USB Communications (Port 2)

The USB interface provides Type-A and Type-B connectors.

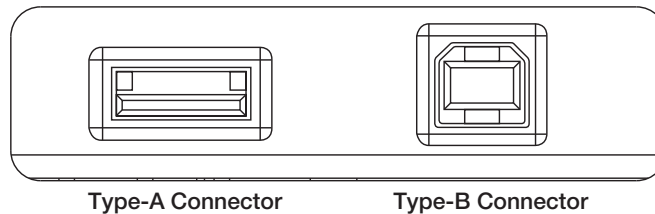

Figure 3-6. USB Interface Board Connections

Compatible devices using a Type-A connector include a flash drive, keyboard, USB hub and label and ticket printers. The host PC uses a Type-B connector.

3.3.6 Keyboard Interface

Serial Interface

Serial port 2 on the 920i CPU board provides a PS/2-type keyboard interface for use with a remote keyboard. To use the keyboard interface, set the INPUT parameter for Port 2 (under the SERIAL menu) to **KEYBD**.

Table 3-8 summarizes the 920i specific functions provided by the keyboard interface; most other alphanumeric and navigational keys provide functions equivalent to those typical for PC operation. Menu parameters and serial commands that affect indicator keypad operation (including the KBDLCK, ZERONLY, and KLOCK serial commands) also affect the remote keyboard.



NOTE: The keyboard interface is not hot-pluggable. Disconnect power to the 920i before plugging the keyboard cable into the Port 2 connector.

The 920i supports keyboard scan codes 1, 2, and 3.

USB Interface

The 920i USB interface board provides a type-A connection for a USB keyboard interface. To use the keyboard interface, set the DEVICE parameter for Port 2 (under the SERIAL menu) to **KEYBOARD**.

Table 3-8 summarizes the 920i specific functions provided by the keyboard interface; most other alphanumeric and navigational keys provide functions equivalent to those typical for PC operation. Menu parameters and serial commands that affect indicator keypad operation (including the KBDLCK, ZERONLY, and KLOCK serial commands) also affect the remote keyboard.

Key	Function
F1	Softkey 1
F2	Softkey 2
F3	Softkey 3
F4	Softkey 4
F5	Softkey 5
F6 (Alt+Z)	ZERO key
F7 (Alt+G)	GROSS/NET key
F8 (Alt+T)	TARE key
F9 (Alt+U)	UNITS key
F10 (Alt+P)	PRINT key
F11	--
F12	
Print Screen	Same as Print key, in both normal and setup modes

Table 3-8. PS/2 Keyboard Functions

3.3.7 Digital I/O

Digital inputs can be set to provide several indicator functions, including keypad. Digital inputs are active low (0 VDC), inactive high (5 VDC).

Digital outputs are typically used to control relays that drive other equipment. Outputs are designed to sink, rather than source, switching current. Each output is a normally open collector circuit, capable of sinking 24 mA when active. Digital outputs are wired to switch relays when the digital output is active (low, 0 VDC) with reference to a 5 VDC supply.

J2 Pin	J2 Signal
1	+5 VDC
2	GND
3	DIO 1
4	DIO 2
5	DIO 3
6	DIO 4
7	DIO 5
8	DIO 6

Table 3-9. J2 Pin Assignments (Digital I/O)

Digital inputs and outputs are configured using the **DIG I/O** menu. See [Section 4.11 on page 53](#) for configuration information. An optional 24-channel digital I/O expansion card, PN 67601, is available for applications requiring more digital I/O channels. Digital I/O points can be configured to count active pulse inputs by setting them to **PROGIN** and using the iRite **DigInSsBbActivate** handler. The fastest pulse rate that can be counted using a digital input is 10Hz (10 pulses per second). More demanding applications can use the pulse input option card (PN 67603) to count pulses in the 4–4000 Hz range.

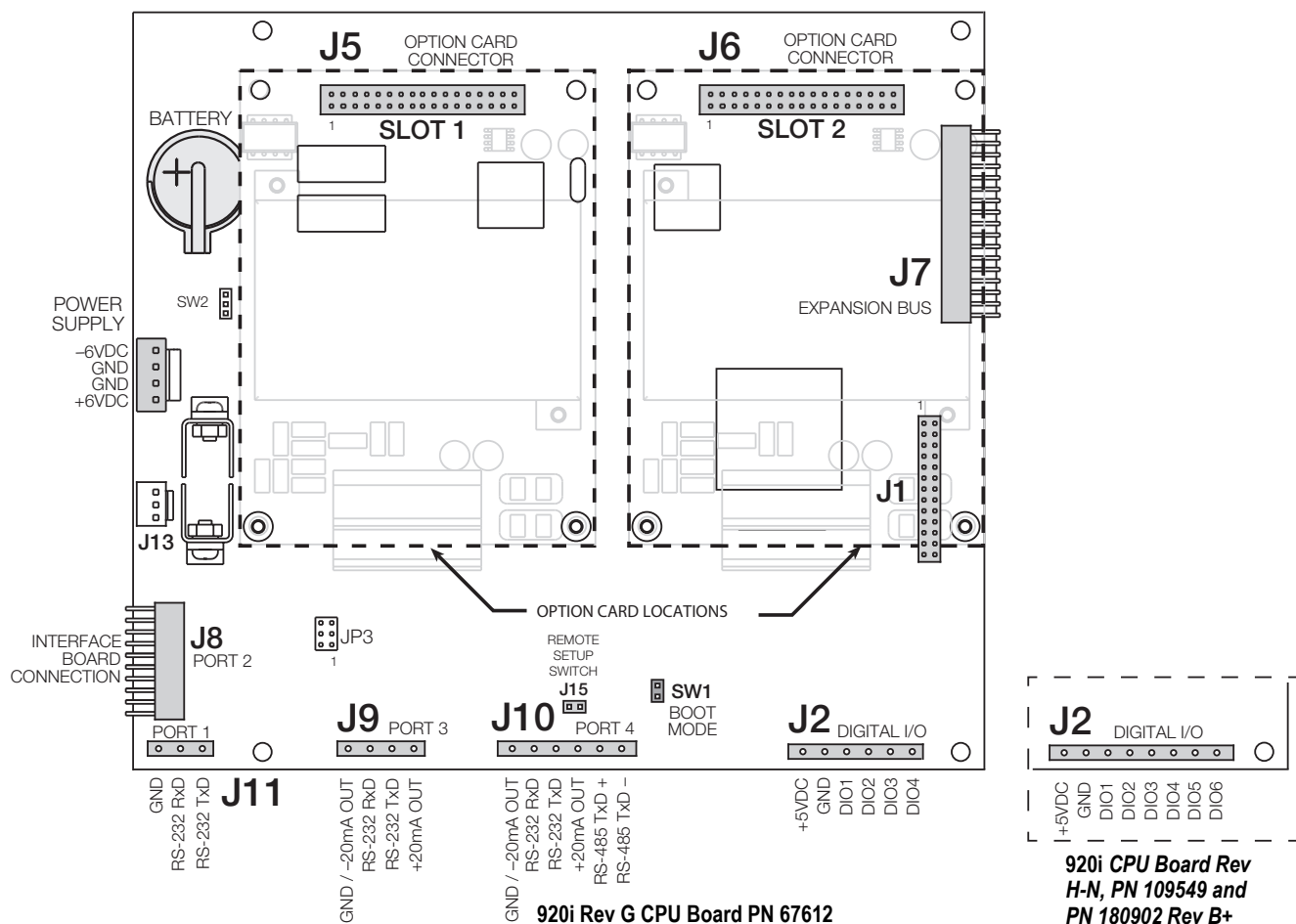

Figure 3-7. 920i CPU Board

3.4 Ground Cables/Wires

Except for the power cord, all cables routed through the cord grips should be grounded against the indicator enclosure.

1. Install the grounding clamps on an enclosure stud near the cord grip being used.
2. Secure the ground clamp with hardware included in the hardware kit. Do not tighten the screws at this time.
3. Route the cables through the cord grips and the grounding clamps to determine the cable lengths required to reach the cable connectors.
4. Mark the cables to remove insulation and shield (Section 3.4.1).
5. Route stripped cables through the cord grips and grounding clamps.
6. Ensure the shields contact the grounding clamps and tighten the ground clamp screws.

3.4.1 Stripping Cables

Foil Insulated Cable

1. Strip the insulation and foil from the cable 1/2" (15 mm) past the grounding clamp.

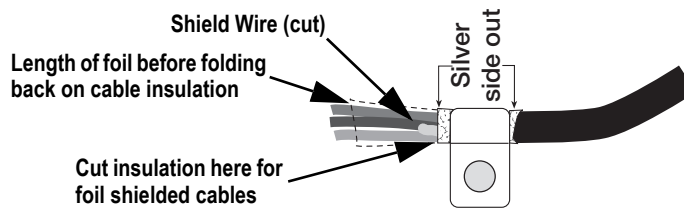

Figure 3-8. Foil Insulated Cable

2. Fold the foil shield back on the cable where the cable passes through the clamp.
3. Ensure the silver (conductive) side of the foil is turned outward for contact with the grounding clamp.



NOTE: To strip the load cell cable, see *Load Cell Cable* below.

Braided Shielding

1. Strip the insulation and braided shield from a point just past the grounding clamp.

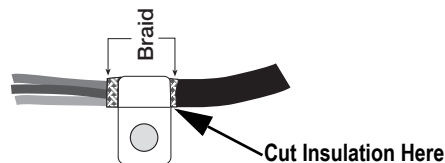

Figure 3-9. Braided Insulated Cable

2. Strip another 1/2" (15 mm) of the insulation to expose the braid where the cable passes through the clamp.

Load Cell Cable

Cut the shield wire just past the grounding clamp. Shield wire function is provided by contact between the cable shield and the grounding clamp.

3.5 Installing Option Cards

Each option card is shipped with installation instructions specific to that card.



CAUTION: Option cards are not hot-pluggable. Disconnect power to the 920i before installing option cards.

The general procedure for all option cards is as follows:

1. Disconnect power to the indicator.
2. Remove backplate as described in [Section 3.2.1 on page 10](#).
3. Carefully align the option card connector with connector J5 or J6 on the CPU board.
4. Press down to seat the option card in the CPU board connector.
5. Use the screws provided in the option kit to secure the other end of the option card to the threaded standoffs on the CPU board.
6. Make connections to the option card as required.
7. Use cable ties to secure loose cables inside the enclosure.
8. When installation is complete, reassemble the enclosure as described in [Section 3.2.2 on page 10](#).

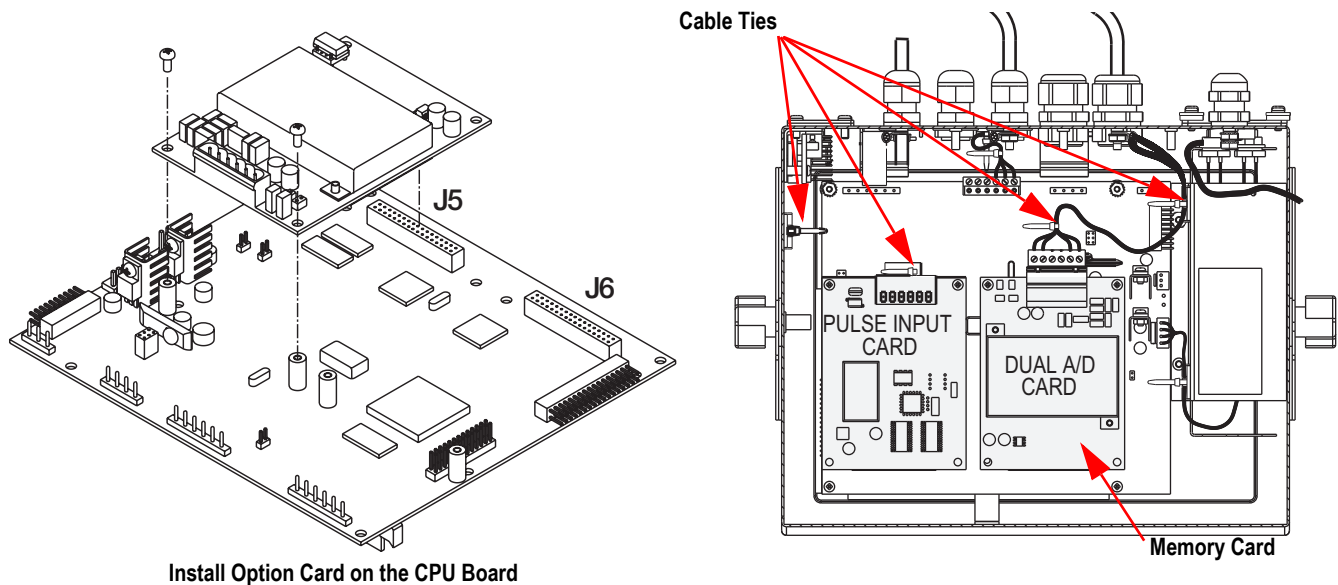

Figure 3-10. Install Option Card

The 920i automatically recognizes all installed option cards when the unit is powered on. No hardware-specific configuration is required to identify the newly-installed card to the system.

3.6 Sealing the Front Door

In Legal for Trade applications, it is necessary to seal the indicator to restrict access to the internal hardware of the indicator. To seal the wall mount enclosure front door, wrap the lead wire seal through the large screw securing the front door and the hole in the edge of the door enclosure. Alternatively, the A/D scale card includes fillister screws and a bracket that prevent that load cell cable from being disconnected.

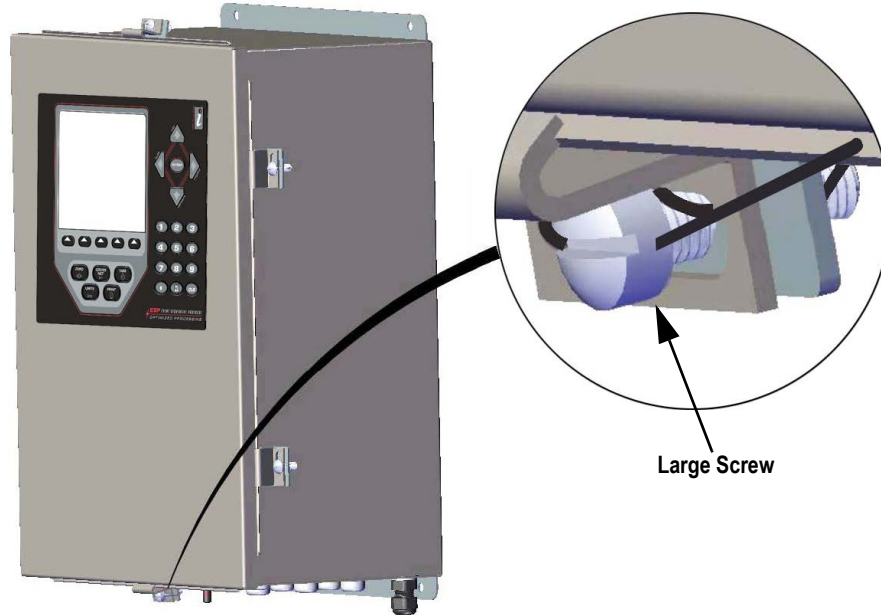

Figure 3-11. Panel Mount Sealing

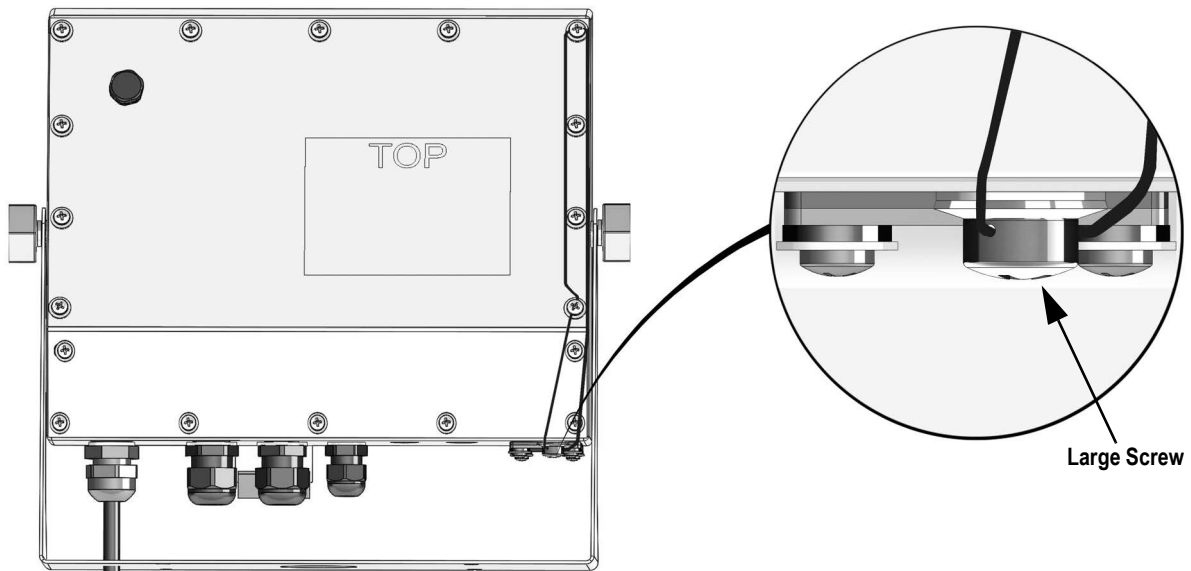

Figure 3-12. Universal Mount Sealing

3.7 Expansion Board Configurations

Two- and six-card expansion boards allow up to fourteen option cards to be attached to the 920i. [Figure 3-13](#) illustrates the slot numbers assigned for various combinations of two- and six-card expansion boards. A single six-card expansion board is assigned slots 3–8.

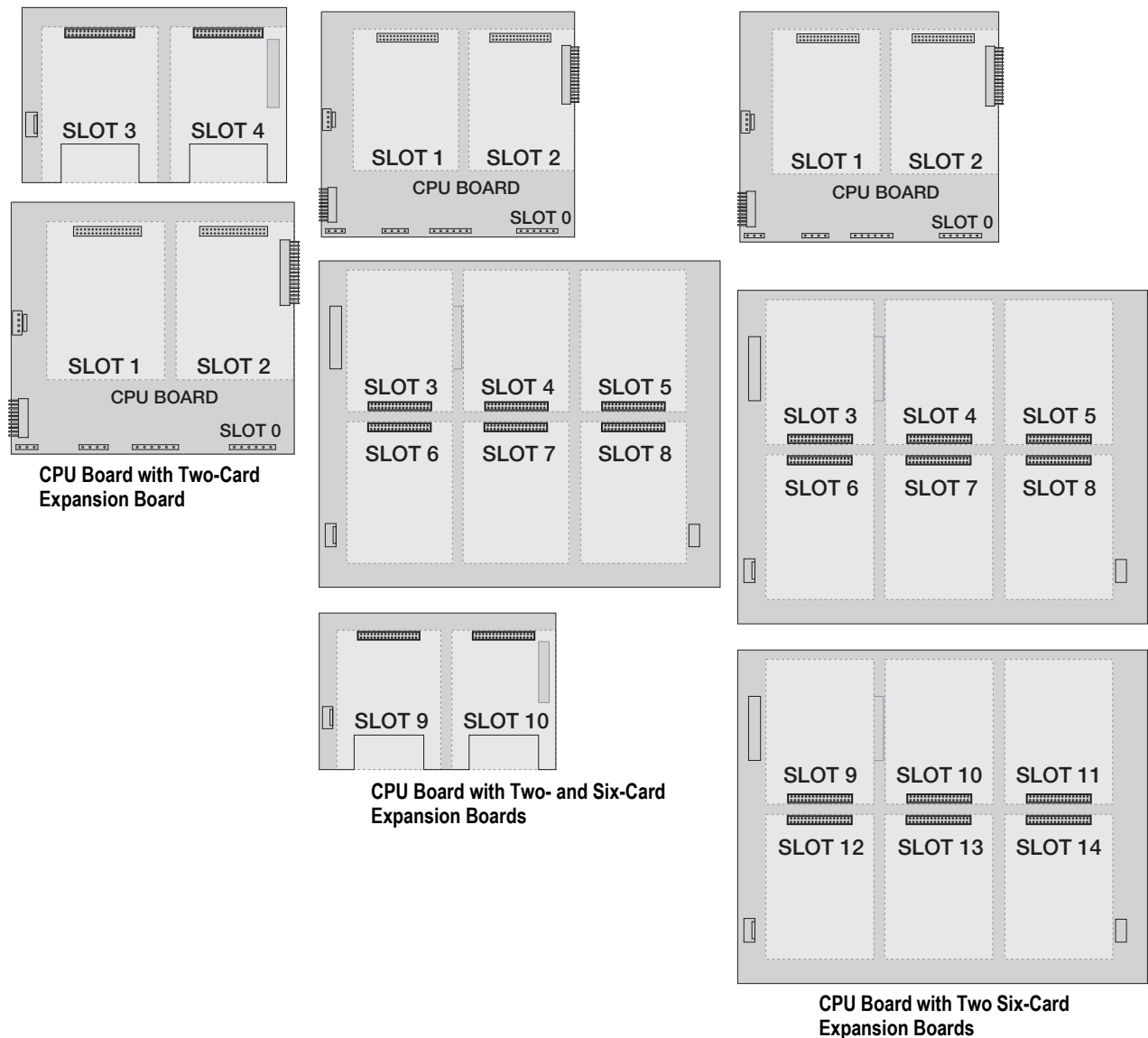

Figure 3-13. CPU Board with Expansion Cards



NOTE: The maximum number of option board slots is fourteen: two on-board slots, plus two six-card expansion boards.

The two-card expansion board is always placed at the end of the expansion bus. No more than one two-card expansion board can be used in any system configuration.

The panel mount enclosure can accommodate a single two-card expansion board.

The wall mount enclosure can accommodate a two-card and/or a six-card expansion board.

Systems using two six-card expansion boards are housed in a custom enclosure.

3.7.1 Expansion Board Serial Port Assignments

Serial port numbers are reserved for each option card slot, regardless of the type of cards actually installed. Two port numbers are reserved for each slot that could contain a dual-channel serial expansion card. Table 3-10 shows the port numbers assigned to each slot.

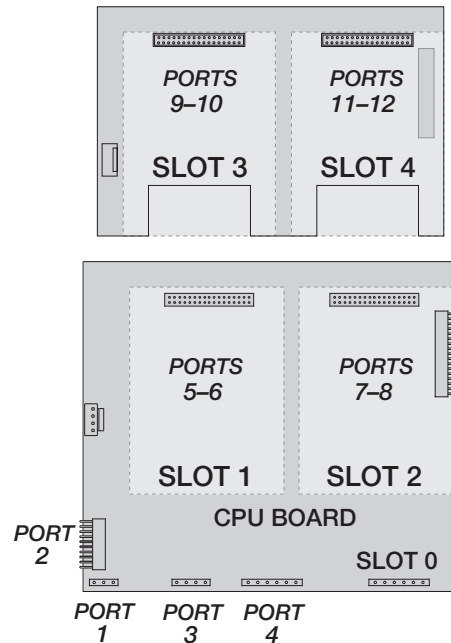

Figure 3-14. Serial Port Assignments, Two-Card Expansion Board

Slot Number	Serial Port Assignments
CPU board	1-4
1	5-6
2	7-8
3	9-10
4	11-12
5	13-14
6	15-16
7	17-18
8	19-20
9	21-22
10	23-24
11	25-26
12	27-28
13	29-30
14	31-32

Table 3-10. Expansion Board Serial Port Assignments

Example: In a system with a two-card expansion board, port assignments are reserved as illustrated in Figure 3-14. If the only serial card installed in this system is in SLOT 4 of the expansion board, the system consists of serial ports 1-4 (on the CPU board) and ports 11-12.

3.8 CPU Board Removal

To remove the 920i CPU board, use the following procedure:

1. Disconnect power to the indicator. Remove backplate as described in [Section 3.2 on page 10](#).
2. Unplug connectors J9, J10, and J11 (serial communications), J2 (digital I/O), P1 (power supply), and connectors to any installed option cards.
3. Remove any installed option cards.
4. Remove the screws and nuts securing the CPU board.
5. Gently lift the CPU board and disconnect connectors J12 (power to display), J4 (ribbon cable), J3 (keypad connector) and the cable in J8 (Port 2 serial port).
6. Remove CPU board from the enclosure. If necessary, cut cable ties to shift cables out of the way.

To replace the CPU board, reverse the above procedure. Be sure to reinstall cable ties to secure all cables inside the indicator enclosure.

3.9 Battery Replacement

The lithium battery on the CPU board maintains the real-time clock and protects data stored in the system RAM when the indicator is not connected to AC power.

Data protected by the CPU board battery includes time and date, truck and tare memory, onboard database information and setpoint configuration.

Use iRev 4 to store a copy of the indicator configuration on a PC before attempting battery replacement. If any data is lost, the indicator configuration can be restored from the PC.



NOTE: Memory option card data is also protected by a lithium battery. All database information stored on a memory card is lost if the memory card battery fails.

Watch for the low battery warning on the LCD display and periodically check the battery voltage on both the CPU board and on any installed memory option cards. Batteries should be replaced when the indicator low battery warning comes on, or when battery voltage falls to 2.2 VDC. Life expectancy of the battery is 10 years.

Battery Removal

Place the tip of a finger in notched area near the battery retaining spring and slide the battery out of position on the CPU board.

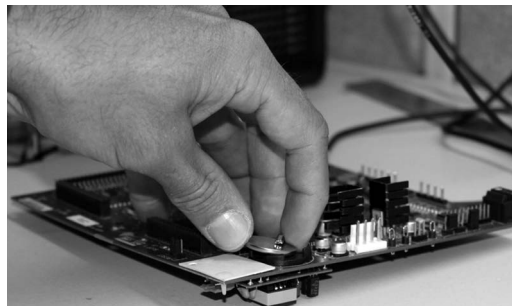

Figure 3-15. Battery Removal

3.9.1 Replacement

Before replacing the battery, place the indicator in setup mode, then press SAVE/EXIT to save battery-backed memory (NVRAM) to flash. This operation saves the latest configuration information, including setpoint values, stored strings and data, and the onboard database, to flash memory.

Return to weigh mode, power off the indicator, and replace the battery. Use care not to bend the battery retaining spring.

When power is restored, a message is shown stating that battery-backed memory is corrupt. Press **Enter** to restore the values saved in flash memory.

See [Figure 3-7 on page 17](#) for CPU board battery location and orientation (positive side up).



CAUTION: Danger of explosion if battery is incorrectly replaced. Replace only with the same or equivalent type recommended by the manufacturer. Dispose of unused batteries according to the manufacturer's instructions.

3.10 Parts Kit

Table 3-11 lists the parts kit contents for the universal model.

Part No.	Descriptions	Qty
42149	Bumper, Rubber Grommet	4
103610	Knob, Black 1/4-20	2
103988	Washer, Nylon 0.515 - 0.52	2
14626	Nut, Kep 8-32NC Hex	4
14862	Screw, Mach 8-32NC x 3/8	12
15133	Washer, Lock No. 8 Type A	4
15631	Cable Tie, 3" Nylon	4
15665	Gland, Reducing 1/2NPT	2
15887	Terminal Block, 6-Position	1
174928	Label, NOM/NYCE 920i	1
19538	Post Plug, Slotted Black	4
30623	Screw, Mach 8-32NC x 7/16	2
53075	Clamp, Ground Cable Shield	4
70599	Conn, 6-Position Screw Terminal	1
71125	Conn, 3-Position Screw Terminal	1
71126	Conn, 4-Position Screw Terminal	1
75062	Washer, Bonded Sealing #8	14
77180	Conn, 8-Position Screw Terminal	1
94422	Label, Capacity 0.40 x 5.00	1

Table 3-11. Parts Kit (PN126285)

3.10.1 LED Backlight

The 920i display is now shipped with an improved LED backlight, replacing the CCFL (Fluorescent) backlight.

The improved LED backlight is compatible with all older CPU boards (green solder mask), however, a new power supply cable is required. For the Blue CPU board (PN 180902) a retrofit cable is not required.



NOTE: The CCFL (Fluorescent) backlight is still available for purchase.

Power AC Original Power Cable	Where Used	LED Backlight on Green CPU
67796	Universal	186464
71430	Panel Mt, Deep Univ	186278
71431	Wall Mt	186760
71757	2 Slot Wall Mt	188716
71758	2 Slot Panel Mt, Deep Univ	188717
71430	6 Slot Wall Mt	186278
71759	Expansion	188774

Power DC/DC Original Power Cable	Where Used	LED Backlight on Green CPU
67796	Universal	186464
175824	Panel Mt, Deep Univ	187603
158620	Wall Mt	188345
179487	2 Slot Wall Mt DC/DC	189424
181032	2 Slot 180047 Panel Mt DC/DC	189425

Table 3-12. Retrofit Cables for Display with LED Backlight, Used with Green CPU Only

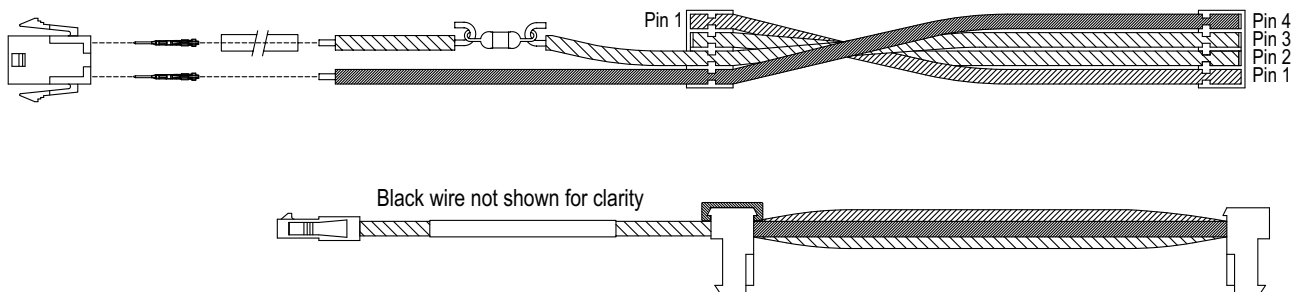

Figure 3-16. Retrofit Wire Harness for LED Backlight Display with Green CPU Board

3.11 Replacement Parts Illustrations

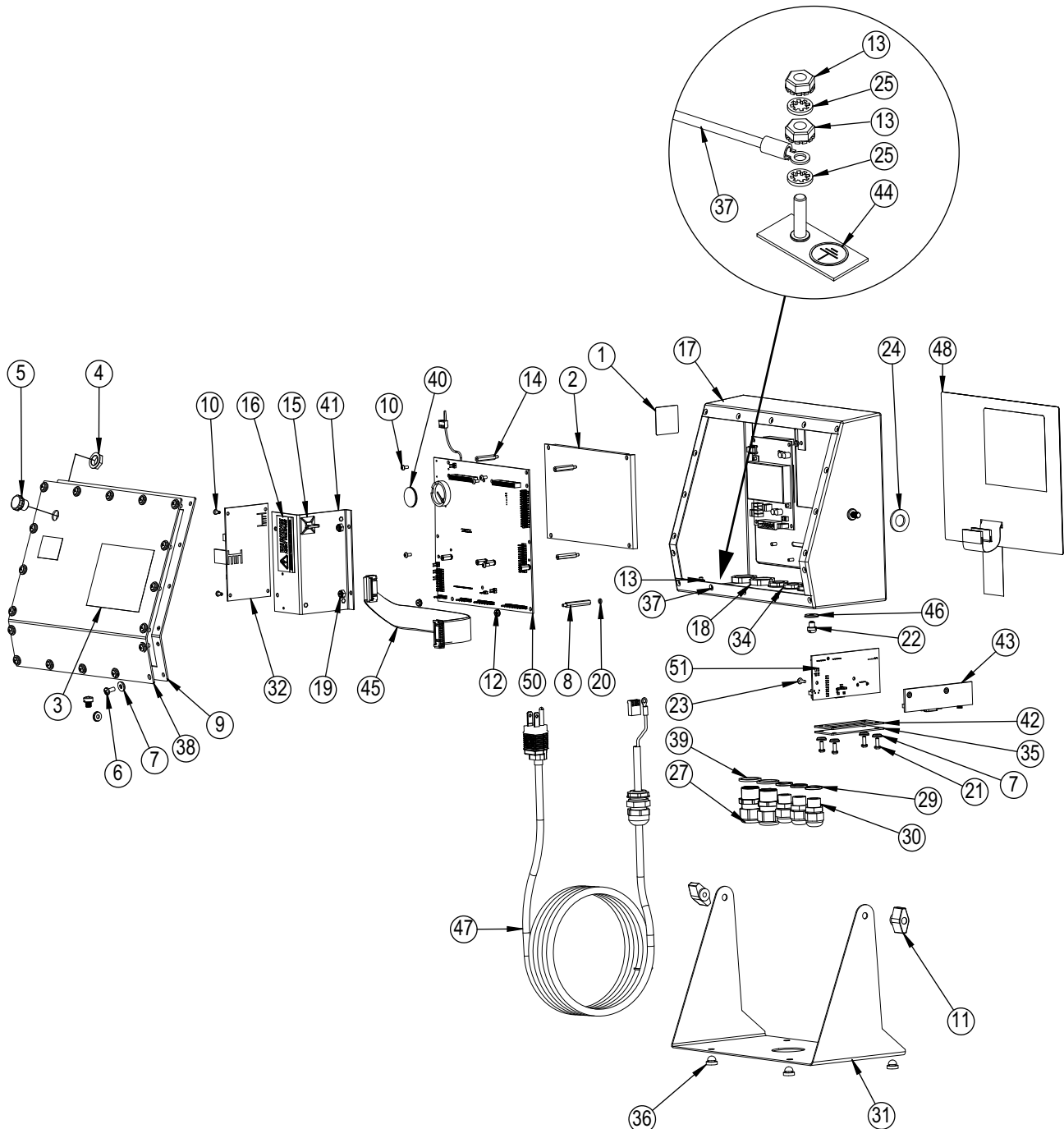

Figure 3-17. Universal Enclosure Parts Illustration



NOTE: See the following for replacement parts information:

- **Panel Mount Installation Instructions (PN 69989)**
- **Wall Mount Installation Instructions (PN 69988)**
- **Deep Mount Installation Instructions (PN 83810)**

Item No.	Part No.	Descriptions	Qty.	Item No.	Part No.	Descriptions	Qty.
1	53308	Label, 1.25 x 1.25	1	29	30375	Seal Ring, Nylon PG9	3
2	186275	Display, Module Transmissive, LED B/L	1	30	15626	Cord Grip, Black PG9	3
	186276	Display, Module Transflective, LED B/L	1	31	67531	Stand, Tilt	1
3	53307	Label, 4.000 x 2.875	1	32	67613	Power Supply, 120-240 VAC, 25 W	1
4	88734	Nut, Breather Vent	1		132791	Power Supply, 12-24 VDC, 25 W	1
5	88733	Vent, Breather Sealed	1		71333	Power Supply, VAC, 65 W	1
6	14862	Screw, Mach 8-32NC x 3/8	4	33	186464	Wire Harness for Universal, Green CPU	1
7	75062	Washer, Bonded Sealing #8	8		67796	Wire Harness for Universal, Blue CPU	1
8	68661	Standoff, Male-Fem 4-40NC	2		71430	Wire Harness for Panel, 65 W	1
9	67532	Gasket Back Plate	1	34	15627	Locknut, Black PCN9	3
10	14822	Screw, Mach 4-40 NC x 1/4	11	35	67530	Plate, Interface Board	1
11	103610	Knob, Black 1/4-20	2	36	42149	Bumper, Rubber Grommet	4
12	14618	Nut, Kep 4-40NC Hex	2	37	45043	Wire Assembly, Ground 4"	1
13	14626	Nut, Kep 8-32NC Hex	3	38	68424	Backplate, Universal	1
14	67886	Standoff, Male-FEM 4-40NC	4	39	30376	Seal Ring, Nylon 1/2 NPT	2
15	15631	Cable Tie, 3" Nylon	1	40	69290	Battery, 3 V Coin Lithium	1
	15650	Mount, Cable Tie 3/4"	1	41	94392	Bracket, 25 W Power Supply	1
16	16861	Label, Warning High	1	42	67535	Gasket, Interface Board	1
17	67529	Enclosure, Universal	1	43	111109	Board Interface USB	1
18	15630	Locknut, 1/2 NPT Black	2		67869	Board Assembly, PS2/DB-9	1
19	58248	Nut, Lock 6-32NC Hex Nylon	2	44	16892	Label, Ground Protective	1
20	69898	Washer, Nylon #4 ID = 0.112	2	45	68662	Cable, Ribbon Interface	1
21	14845	Screw, Mach 6-32NC x 3/8	4	46	44676	Washer, Bonded Sealing	1
22	42640	Screw, Mach 1/4-28NF x 0.25	8		85202	Power Cord Assembly, 120 VAC	1
23	55708	Screw, Mach 4-40NC x 0.38	2	85203	Power Cord Assembly, 240 VAC Euro Plug		
24	103988	Washer, Nylon 0.515 -0.52	2	48	66502	Overlay, Membrane Switch	1
25	15134	Washer, Lock No. 8 Type A	3	49	68216	Nameplate, Rice Lake	1
27	15628	Cord Grip, 1/2 NPT Black	2	50	117930	Board Assembly, Green CPU for CCFL B/L	1
28	67610	Card, A/D Single Channel	1		186272	Board Assembly, Blue CPU for LED B/L	1

Table 3-13. Universal Enclosure Parts List



CAUTION: To protect against the risk of fire, replace fuses only with same type and rating fuse.

See Section 15.0 on page 136 for specifications.

4.0 Configuration



NOTE: See the 920i Technical Manual (PN 67887) for section references not found in this manual.

The 920i indicator can be configured by using the front panel keys to navigate through a series of configuration menus or by sending commands or configuration data to an indicator serial port. If there is no serial port on port 2, refer to [Section 7.0 on page 70](#). Configuration using the menus is described in this section.

Configuration using the serial port can be accomplished using either the serial command set described in [Section 11.0 on page 103](#) or the iRev 4 configuration utility.



NOTE: The 920i display and widgets, cannot be accessed through the configuration menus. iRev 4 provides the most complete and efficient configuration interface for the 920i.

4.1 iRev™ Configuration

The iRev configuration utility provides the preferred method for configuring the 920i indicator. iRev 4 runs on a personal computer to set configuration parameters for the indicator. When iRev 4 configuration is complete, configuration data is downloaded to the indicator.

iRev supports both uploading and downloading of indicator configuration data. This capability allows configuration data to be retrieved from one indicator, edited and downloaded to another indicator with an identical hardware configuration.

See [Section 6.0 on page 62](#) for more information about using iRev to configure the 920i.

4.2 Serial Command Configuration

The serial command set can be used to configure the 920i indicator using either a personal computer, terminal, or remote keyboard. Like iRev 4, serial command configuration sends commands to the indicator serial port; unlike iRev 4, serial commands can be sent using any external device capable of sending ASCII characters over a serial connection.

Serial commands duplicate the functions available using the indicator front panel and provide some functions not otherwise available. Serial commands can be used to simulate pressing front panel keys, to configure the indicator, or to dump lists of parameter settings. See [Section 11.0 on page 103](#) for more information about using the serial command set.

4.3 Configuration Switch

To configure the 920i indicator, the indicator must be placed in configuration mode.

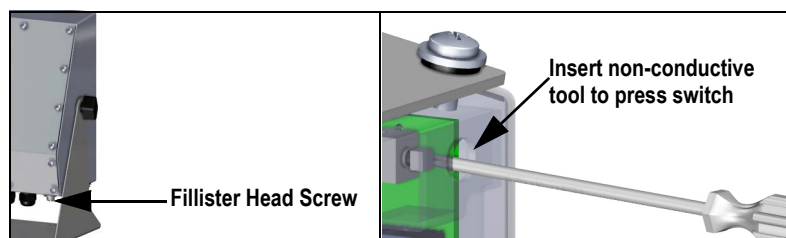

Figure 4-1. Configure Switch – Universal Model

1. Remove the setup switch access screw on the bottom of the universal enclosure.
2. Insert a small non-conductive tool into the access hole to press the switch. The main menu displays.
3. Set parameters as required for scales/system being used.
4. Once configuration is complete, press the **Save and Exit** softkey to exit setup mode.
5. Replace the setup switch access screw.



IMPORTANT: To maintain NTEP certification requirements and to use the scale to record Legal for Trade transactions, the scale must be properly sealed.

**If updating and/or configuring the scale, the seal may need to be broken to enter the menu structure.*

**Removing or altering the seal voids the NTEP approval. For continued certification the unit must be resealed, by an authorized agent, when configuration is complete.*

**There are menus that must be set per NTEP standards, ensure these settings remain NTEP accepted values.*

***Calibration must be performed by a qualified technician familiar with state and local regulations.*

4.4 Front Panel Configuration

Use the **CONFIG** menu under the **SCALES** to configure A/D scales.

1. Place the indicator in configuration mode. The main menu displays.

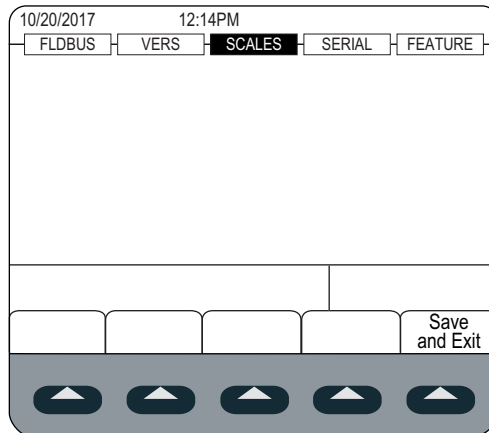





Figure 4-2. Main Menu Display

2. Ensure that **SCALES** is highlighted and press . The scales menu displays the scales that have been set up. If no scales have been setup, only **CONFIG** is displayed.
3. Press  or  to highlight a scale to revise or highlight **CONFIG** to setup a new scale.
4. Press . Scale configuration displays.

Available Scale Types

- A/D's
- Scales
- Ports
- iQubes
- Prog Scale

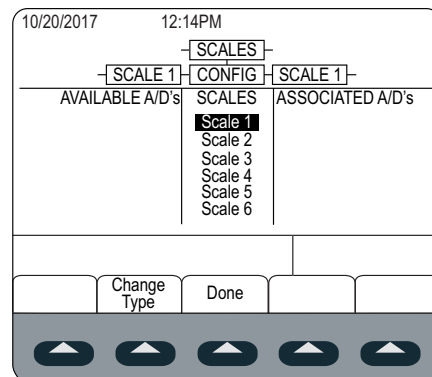







Figure 4-3. Scale Configuration Display

5. Press  to highlight the scale to configure.
6. Press the **Change Type** softkey to select one of the available scale types.
7. Press  and use  or  to highlight the desired scale.
8. Press the **Add** softkey. The selected type displays under Associated A/D's.
9. Press **Add** to associate another A/D or  to the scale #n.
10. Press the **Done** softkey.
11. Repeat [Step 2](#) through [Step 10](#) for each scale.

See [Section 13.2 on page 128](#) for information on configuring serial scales.

4.5 Main Menu

The 920i indicator can be configured using a series of menus accessed through the indicator front panel when the indicator is in setup mode.

SCALES	SERIAL	FEATURE	PFORMT	SETPTS	DIG I/O	ALGOUT	FLDBUS	VERS
--------	--------	---------	--------	--------	---------	--------	--------	------

Figure 4-4. Configuration Menu Flow

Menu	Menu Function
SCALES	Configuration – Configure and calibrate scales (Section 4.6 on page 30)
SERIAL	Serial – Configure communications ports (Section 4.7 on page 39)
FEATURE	Features – Set date and time, truck mode, passwords, keyboard locks, regulatory mode, initial consecutive number value, define softkeys and setpoint prompts (Section 4.8 on page 46)
PFORMT	Print Format – Set print format used for header, gross, net, truck in/out, setpoint and auxiliary ticket formats (Section 4.9 on page 51)
SETPTS	Setpoints – Configure setpoints and batching mode (Section 4.10 on page 52)
DIG I/O	Digital I/O – Assign digital input/output functions (Section 4.11 on page 53)
ALGOUT	Analog Output – Configure analog output module; displayed only if analog output option is installed (Section 4.12 on page 55)
FLDBUS	Fieldbus – Configure fieldbus parameters for PROFIBUS, PROFINET, DeviceNet, EtherNet/IP and ControlNet communications; Displayed only if one of the listed fieldbus cards is installed
VERSION	Version – Displays installed software version number; The Reset Config softkey on the Version menu can be used to restore all configuration parameters to their default values

Table 4-1. 920i Menu Summary

The 920i indicator can be configured by using the front panel keys to navigate through a series of configuration menus or by sending commands or configuration data to an indicator serial port. If there is no serial port on port 2, refer to [Section 7.0 on page 70](#). Configuration using the menus is described in [Section 4.4 on page 28](#).

Configuration using the serial port can be accomplished using either the serial command set described in [Section 11.0 on page 103](#) or the iRev 4 configuration utility.



NOTE: The 920i display and widgets, cannot be accessed through the configuration menus. iRev provides the most complete and efficient configuration interface for the 920i.

4.6 Scales Menu

The **Scale x** menu allows configuration and calibration of each scale. **Config** lists available and associated A/Ds.

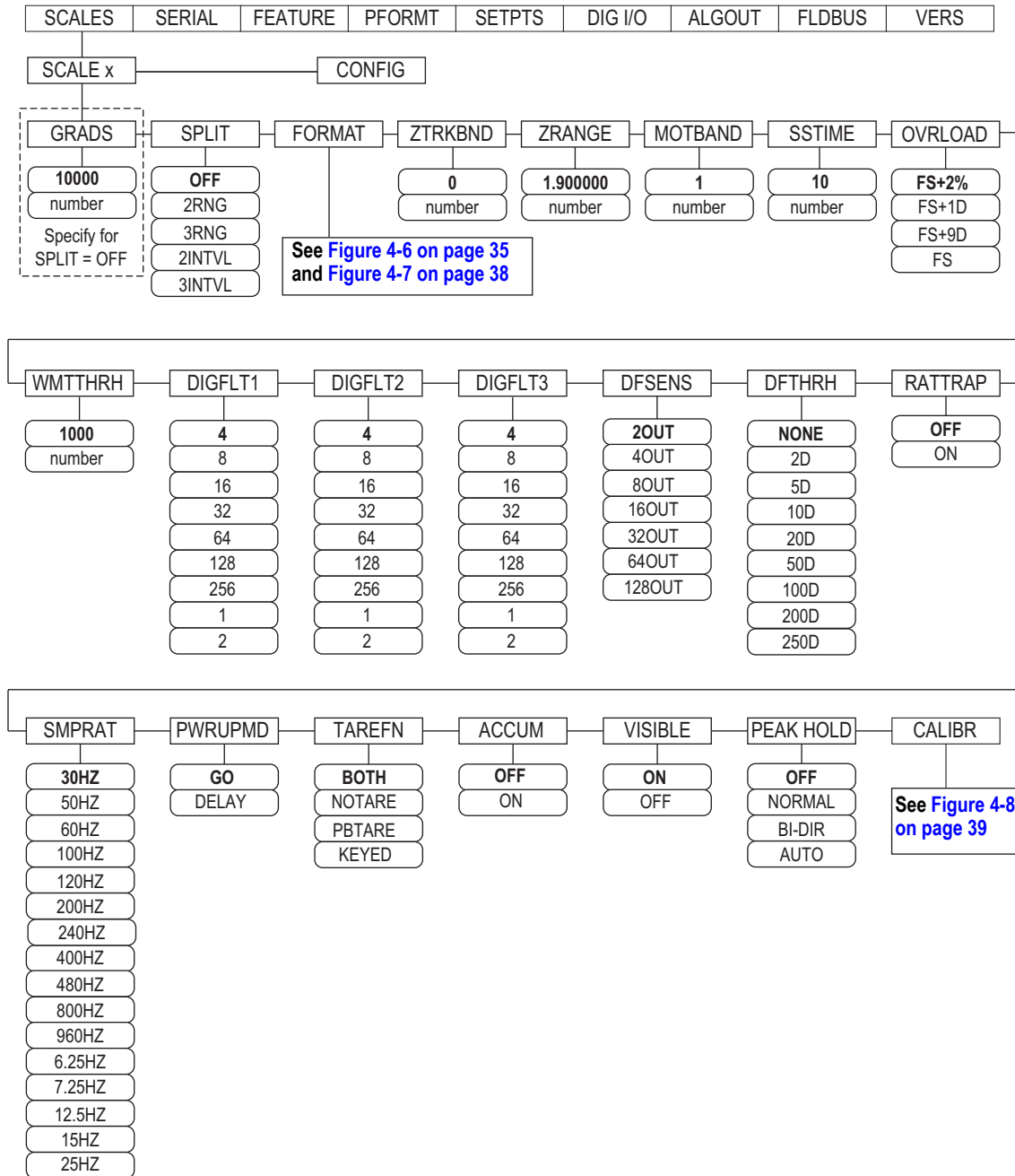

Figure 4-5. Scales Menu

Parameter	Descriptions
GRADS	Graduations – Specifies number of full scale GRADS if SPLIT = OFF ; GRADS = Capacity / Display Divisions , see Figure 4-7 on page 38 for display divisions; Settings: 1–9999999 (10000 default), must be consistent with legal requirements and environmental limits on system resolution; For Multi-range and Multi-interval scales (SPLIT = OFF), the GRADS is calculated using the capacity and display divisions specified for the range or interval
SPLIT	Split – Specifies the range or interval of the scale; Settings: <ul style="list-style-type: none"> • OFF = full-range (default) • 2RNG, 3RNG = multi-range • 2INTVL, 3INTVL = multi-interval For Multi-range and Multi-interval scales (Table 4-4 on page 36 and Table 4-6 on page 38)
FORMAT	Format – Specifies scale units: Primary (PRIMAR default), Secondary (SECNDR), Tertiary (TERTIA) or Rate of Change (ROC); <ul style="list-style-type: none"> • SPLIT = OFF – (Table 4-4 on page 36) • SPLIT = OFF – multi-range and multi-interval scales (Table 4-6 on page 38)
ZTRKBND	Zero Track Band – Automatically zeros scale when in a specified range, as long as the input is in the range and scale is at standstill; Zero tracking band is specified in \pm display divisions; maximum legal value varies depending on local regulations; enter value: 0 (default) NOTE: For scales using linear calibration, do not set zero tracking band to a value greater than the value set for the first point.
ZRANGE	Zero Range – Specifies the range within which the scale can be zeroed; Enter value: 1.900000 (default) <i>Example: $\pm 1.9\%$ around the calibrated zero point for a total range of 3.8%</i> Indicator must be at standstill to zero the scale; Use the default value for Legal-for-Trade applications
MOTBAND	Motion Band – Sets the level, in display divisions, at which scale motion is detected; If motion is not detected for the SSTIME (default of 1 second) or more, the standstill symbol lights; Some operations, including print, tare, and zero, require the scale to be at standstill; the value entered must be in the range of 0–100; maximum legal value varies depending on local regulations NOTE: If set to 0, the standstill annunciator is set continuously on, and operations including zero, print, and tare will be performed regardless of scale motion; If 0 is selected, ZTRKBND must also be set to 0
SSTIME	Stand Still Time – Specifies the length of time the scale must be out of motion, in 0.1-second intervals, before the scale is considered to be at standstill; Enter value: 10 (default), values greater than 10 (1 second) are not recommended
OVRLD	Determines the point at which the display blanks and an out-of-range error message is displayed; Maximum legal value varies depending on local regulations; settings: FS+2% (default), FS+1D, FS+9D, FS
WMTHRH	Weighment Threshold – Specifies minimum number of grads required to add weighment to the recorded number of weighments; Enter value, 1000 (default)
DIGFLT1 DIGFLT2 DIGFLT3	Digital Filtering – Selects the digital filtering rate used to reduce the effects of mechanical vibration from the immediate area of the scale; Selected setting indicates the number of A/D conversions per update that are averaged to obtain the displayed reading; A higher number gives a more accurate display by minimizing the effect of a noisy readings, but slows down the settling rate of the indicator; Settings: 1, 2, 4 (default), 8, 16, 32, 64, 128, 256 NOTE: When configuring non-A/D scales, set the DIGFLTx parameters to 1 to disable filtering See Section 4.6.1 on page 33 for more information about digital filtering
DFSENS	Digital Filter Cutout Sensitivity – Specifies the number of consecutive readings that must fall outside the filter threshold (DFTHRH parameter) before digital filtering is suspended; Settings: 20UT (default), 40UT, 80UT, 160UT, 320UT, 640UT, 1280UT; See Section 4.6.1 on page 33 for more information about digital filtering
DFTHRH	Digital Filter Cutout Threshold – Specifies the filter threshold, in display divisions; When a specified number of consecutive scale readings (DFSENS parameter) fall outside of the threshold, digital filtering is suspended; If NONE is selected, the filter is always enabled; Settings: NONE (default), 2D, 5D, 10D, 20D, 50D, 100D, 200D, 250D; See Section 4.6.1 on page 33 for information about digital filtering
RATTRAP	RATTLETRAP® – The most effective at filtering repeating vibrations caused by mechanical noise from nearby machines, but may increase settling times over standard digital filter selections; Settings: OFF (default), ON – enables RATTLETRAP

Table 4-2. Scale x Menu Parameters

Parameter	Descriptions
SMPRAT	Sample Rate – Selects measurement rate, in samples per second, of the analog-to-digital converter; Lower sample rate values provide greater signal noise immunity; settings: 6.5HZ, 7.5HZ, 12.5HZ, 15HZ, 25HZ, 30HZ (default), 50HZ, 60HZ, 100HZ, 120HZ, 200HZ, 240HZ, 400HZ, 480HZ, 800HZ, 960HZ NOTE: The maximum total sample rate for all configured A/D channels—the sum of the sample rates for all scales—is 1200 Hz. Example: Up to ten scales can be configured with 120 Hz sample rates or up to twenty scales with 60 Hz sample rates.
PWRUPMD	Power Up Mode – Sets the indicator to go into operation immediately after a brief power up display test; Settings: <ul style="list-style-type: none"> • GO (default) – Indicator goes into operation immediately after a brief power up display test • DELAY – Indicator performs a power up display test and enters a 30-second warm-up period; If no motion is detected during warm up, the indicator becomes operational; If motion is detected, the delay timer is reset and the warm up is repeated
TAREFN	Enables or disables push-button and keyed tares; Settings: <ul style="list-style-type: none"> • BOTH (default) Both push-button and keyed tares are enabled • NOTARE -----No tare allowed (gross mode only) • PBTARE -----Push-button tares enabled • KEYED -----keyed tare enabled
ACCUM	Accumulator – Specifies if the scale accumulator is enabled or not; If it is, accumulation occurs whenever a print operation is performed; Settings: OFF (default), ON
VISIBL	Scale Visibility – Specifies whether scale data is displayed; Settings: ON (default), OFF
PEAK HOLD	Peak Hold – Used to determine, display, and print the greatest net weight read during a weighing cycle for the displayed scale; Weighing cycle ends when a print command is executed (AUTO setting) or when the peak weight is cleared by pressing Zero or Print ; press Gross/Net to display gross weight data when using the peak hold function: <ul style="list-style-type: none"> • OFF (default) ---- Peak hold function is off • NORMAL -----Positive peak, manual reset; greatest net weight is held in memory until the weight is removed from the scale and either the Zero or Print key is pressed • BI-DIR -----Bi-directional peak, manual reset; same as NORMAL, but peak value can be either positive or negative, determined by absolute value • AUTO -----Positive peak, auto print, auto reset; automatic print occurs when scale load is 0 ± 10 display divisions and at standstill; following the print command, the peak value is cleared and reset automatically NOTE: If the 920 is connected to multiple scales, the auto print function occurs on the displayed scale.
CALIBR	Calibration – Set parameters for calibration (Table 4-7 on page 39)

Table 4-2. Scale x Menu Parameters (Continued)

4.6.1 Digital Filtering

Standard digital filtering uses mathematical averaging to eliminate the variant digital readings that the A/D converter sends periodically because of external vibration. Digital filtering does not affect the indicator measurement rate, but does affect the settling time. The selections from 1 to 256 reflect the number of readings averaged per update period. When a reading is encountered that is outside a predetermined band, the averaging is overridden, and the display jumps directly to the new value.

DIGFLTx Parameters

The first three digital filtering parameters, DIGFLT1, DIGFLT2, and DIGFLT3, are configurable filter stages that control the effect of a single A/D reading on the displayed weight. The value assigned to each parameter sets the number of readings received from the preceding filter stage before averaging.

A rolling average is passed to successive filters for an overall filtering effect that is effectively a weighted average of the product of the values assigned to the filter stages (DIGFLT1 x DIGFLT2 x DIGFLT3) within a time frame corresponding to the sum of the values (DIGFLT1 + DIGFLT2 + DIGFLT3).

Setting the filters to 1 effectively disables digital filtering.

Rattletrap® Filtering

RATTLETRAP digital filtering (RATTRAP parameter set ON) uses a vibration-dampening algorithm to provide a combination of the best features of analog and digital filtering. The RATTLETRAP algorithm eliminates the frequency of a repeating vibration then displays weight equal to the actual weight on the scale less the vibration-induced flaws. It is particularly effective for eliminating vibration effects or mechanical interference from nearby machinery. Using RATTLETRAP filtering can eliminate much more mechanical vibration than standard digital filtering, but will usually increase settling time over standard digital filtering.

Digital Filter Sensitivity and Digital Filter Threshold Parameters

The digital filter can be used by itself to eliminate vibration effects, but heavy filtering also increases settling time.

The DFSENS (digital filter sensitivity) and DFTHRH (digital filter threshold) parameters can be used to temporarily override filter averaging and improve settling time:

- DFSENS specifies the number of consecutive scale readings that must fall outside the filter threshold (DFTHRH) before digital filtering is suspended
- DFTHRH sets a threshold value, in display divisions; when a specified number of consecutive scale readings (DFSENS) fall outside of this threshold, digital filtering is suspended; set DFTHRH to NONE to turn off the filter override

Setting the Digital Filter Parameters

Fine-tuning the digital filter parameters greatly improves indicator performance in heavy-vibration environments.

Use the following procedure to determine vibration effects on the scale and optimize the digital filtering configuration.

1. Place the indicator into setup mode ([Section 4.3 on page 27](#)).
2. Set the digital filter parameters (DIGFLT1–DIGFLT3) to 1.
3. Set DFTHRH to NONE.
4. Return indicator to weigh mode.
5. Remove all weight from the scale and watch the display to determine the magnitude of vibration effects on the scale.
6. Record the weight below which all but a few readings fall. This value is used to calculate the DFTHRH parameter value in [Step 8](#).

Example: if a heavy-capacity scale (10000 x 5 lb) produces vibration-related readings of up to 50 lb, with occasional spikes to 75 lb, record 50 lb as the threshold weight value.

7. Place the indicator in setup mode and set the DIGFLT_x parameters to eliminate the vibration effects on the scale. (Leave DFTHRH set to NONE.) Find the lowest effective value for the DIGFLT_x parameters.
8. Calculate the DFTHRH parameter value by converting the weight value recorded in [Step 6](#) to display divisions:

$$\text{threshold_weight_value} / \text{display_divisions}$$

In the example in [Step 6](#), with a threshold weight value of 50 lb and a display divisions value of 5 lb: $50 / 5 = 10$. DFTHRH should be set to 10D for this example.
9. Set the DFSENS parameter high enough to ignore transient peaks. Longer transients (typically caused by lower vibration frequencies) will cause more consecutive out-of-band readings so DFSENS should be set higher to counter low frequency transients.

Reconfigure as necessary to find the lowest effective value for the DFSENS parameter.

4.6.2 Format Menu

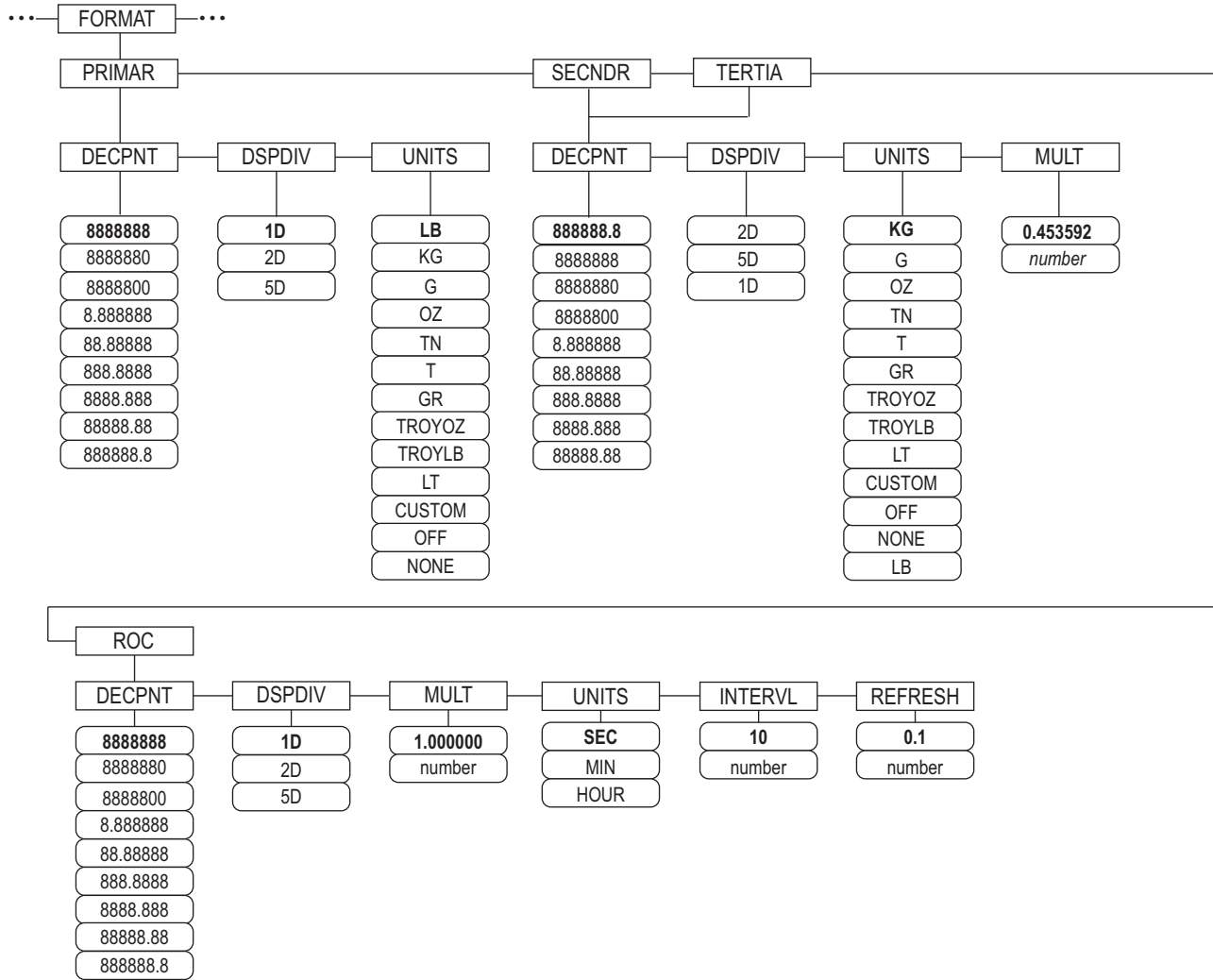

Figure 4-6. Format Menu, SPLIT = OFF

Parameter	Descriptions
PRIMAR	Specifies the decimal position, display divisions, and units used for the primary units
SECNDR	Specifies the decimal position, display divisions, units, and conversion multiplier used for the secondary units
TERTIA	Specifies the decimal position, display divisions, units, and conversion multiplier used for the tertiary units
ROC	Rate of Change – Specifies the decimal position, display divisions, conversion multiplier, time units, update interval, and refresh interval used for the rate of change units

Table 4-3. Format Menu Parameters

Format Menu if Split = OFF

Parameter	Descriptions
DECPNT	Decimal Point Location – Specifies the location of the decimal point or dummy zeros in the unit display; value should be consistent with local legal requirements; Settings: 8888888-888888.8; Defaults: 8888888 (primary and ROC), 888888.8 (secondary and tertiary)
DSPDIV	Display Divisions – Select the minimum division size for the units displayed weight; Settings: 1d (default Primary and ROC), 2d (default Secondary), 5d (default Tertiary)
UNITS	Units for displayed and printed weight; Settings: LB = pound (default Primary); KG = kilogram (default Secondary and Tertiary); G = gram; OZ = ounce; TN = short ton; T = metric ton; GR = grain; TROYOZ = troy ounce; TROYLB = troy pound; LT = long ton, CUSTOM, NONE, OFF NOTE: See below for ROC units.
Secondary and Tertiary Only	
MULT	Multiplier – Specifies the conversion factor by which the primary units are multiplied to obtain the secondary or tertiary units; The entered value is the conversion factor for changing pounds to kilograms; Settings: 0.000001–9999999, 0.453592 (default); See Section 4.6.3 on page 37 for a list of multipliers; To shift between primary, secondary, and tertiary units, press the UNITS key
Rate of Change (ROC) Only	
MULT	Multiplier – Specifies the conversion factor by which the primary units are multiplied to obtain displayed rate of change units; Setting: 0.000001–9999999, 1.000000 (default); See Section 4.6.3 on page 37 for information about conversion factors
UNITS	Rate-of-Change units; Settings: SEC (default), MIN, HOUR
INTERVL	Update Interval – Specifies the number of refreshes over which the rate-of-change is calculated, enter value: 10 (default) <i>Example: REFRESH set to 0.1 second and INTERVL set at 60, each weight value takes 6 seconds (0.1 * 60) to be flushed from ROC data</i>
REFRESH	Refresh interval – Specifies the number of seconds between Rate-of-Change samples; Setting: 0.1 (default)–60
<p>For applications using the ROC function, the primary scale should be configured with a finer resolution than the rate of change (ROC) units to prevent a stepwise appearance in the ROC display; The ROC display step size (weight increment between displayed values) can be roughly calculated as follows: (updates_per_ROC_UNIT) * (PRIMARY_resolution / ROC_resolution)</p> <p><i>Example, with INTERVL=30; REFRESH=0.1; UNITS=MIN; PRIMARY resolution at 0.1 LB and ROC resolution at 1.0 (LB/ MIN)</i></p> <ul style="list-style-type: none"> • $INTERVL * REFRESH = 30 * 0.1 = 3.0$ seconds per update (ROC data is flushed every 3.0 seconds) • With UNITS = MIN, there are 20 ROC data updates per ROC time unit: 60 seconds / 3.0 seconds per update • The resolution ratio of PRIMARY to ROC units is 0.1 (0.1 / 1.0) • This configuration provides a step size in the ROC display of 2 LB (2 LB increments between displayed values) 	

Table 4-4. Format Parameters – SPLIT = OFF

Multi-Range and Multi-Interval Scales

The 920i supports multi-range and multi-interval scales.

Multi-range scales provide two or three ranges, each extending from zero to the maximum capacity specified for the range, that can specify different scale intervals (graduations). The scale interval changes as the applied weight increases but does not reset to lower range intervals until the scale returns to zero.

Multi-interval scales divide the scale into two or three partial weighing ranges, each with different scale intervals.

The scale interval changes with both increasing and decreasing loads applied.

To configure, use the **SPLIT** parameter to select **2RNG** or **3RNG** (for multi-range scales), or **2INTVL** or **3INTVL** (for multi-interval scales). Selecting a **SPLIT** value allows specification of decimal point, display divisions and maximum capacity for each range or interval.

4.6.3 Unit Conversion Factors

The 920i has the capability to mathematically convert and display weight in other units. Press  to scroll through available units.

Set secondary (**SECNDR**) and tertiary (**TERTIA**) units using serial commands.

- To configure secondary or tertiary units using the front panel menus, use the [Table 4-5](#) to find the conversion multiplier for the MULT parameter
 - Example: if the primary unit is pounds and the secondary unit is short tons, set the MULT parameter to 0.000500.*
- To configure secondary or tertiary units using serial commands, use the [Table 4-5](#) to find the conversion multiplier for the SC.SEC.MULT or SC.TER.MULT command

Example: if the primary unit is pounds and the secondary unit is short tons, send the serial command SC.SEC.MULT= 0.0005<CR> to set the multiplier for the secondary units.



NOTE: Ensure that the secondary decimal point position is set appropriately for the scale capacity in the secondary units. If the converted value requires more digits than are available, the indicator displays an overflow message (OVERFL).

Setting the units is for the display and printed output, it does not change the defaulted units in the stream format ([Section 4.7.8 on page 44](#)).

Example: if the primary units are short tons, secondary units are pounds, and the secondary decimal point is set to 8888.888, the indicator will overflow if 5 tons or more are applied to the scale. With 5 tons applied, and a conversion factor of 2000, the secondary units display needs five digits to the left of the decimal point to display the 10000 lb secondary units value.

Primary Unit	x Multiplier	Secondary/ Tertiary Unit
Grains	0.064799	Grams
	0.002286	Ounces
	0.000143	Pounds
	0.000065	Kilograms
	0.002083	Troy ounces
	0.000174	Troy pounds
Ounces	437.500	Grains
	28.3495	Grams
	0.06250	Pounds
	0.02835	Kilograms
	0.911458	Troy ounces
	0.075955	Troy pounds
Pounds	7000.00	Grains
	453.592	Grams
	16.0000	Ounces
	0.453592	Kilograms
	14.58333	Troy ounces
	1.215278	Troy pounds
	0.000500	Short tons
	0.000446	Long tons
	0.000453	Metric tons

Primary Unit	x Multiplier	Secondary/ Tertiary Unit
Grams	15.4324	Grains
	0.035274	Ounces
	0.002205	Pounds
	0.001000	Kilograms
	0.032151	Troy ounces
	0.002679	Troy pounds
Kilograms	15432.4	Grains
	35.2740	Ounces
	1000.00	Grams
	2.20462	Pounds
	32.15075	Troy ounces
	2.679229	Troy pounds
	0.001102	Short tons
	0.000984	Long tons
	0.001000	Metric tons
	Short tons	2000.00
907.185		Kilograms
0.892857		Long tons
0.907185		Metric tons

Primary Unit	x Multiplier	Secondary/ Tertiary Unit
Metric tons	2204.62	Pounds
	1000.00	Kilograms
	1.10231	Short tons
	0.984207	Long tons
Long tons	2240.00	Pounds
	1016.05	Kilograms
	1.12000	Short tons
Troy ounces	1.01605	Metric tons
	480	Grains
	31.10348	Grams
	0.031103	Kilograms
	1.09714	Ounces
	0.068571	Pounds
Troy pounds	0.083333	Troy pounds
	5760	Grains
	373.2417	Grams
	0.373242	Kilograms
	13.16571	Ounces
	0.822857	Pounds
	12	Troy ounces

Table 4-5. Conversion Factors

Format Menu if Split ≠ OFF

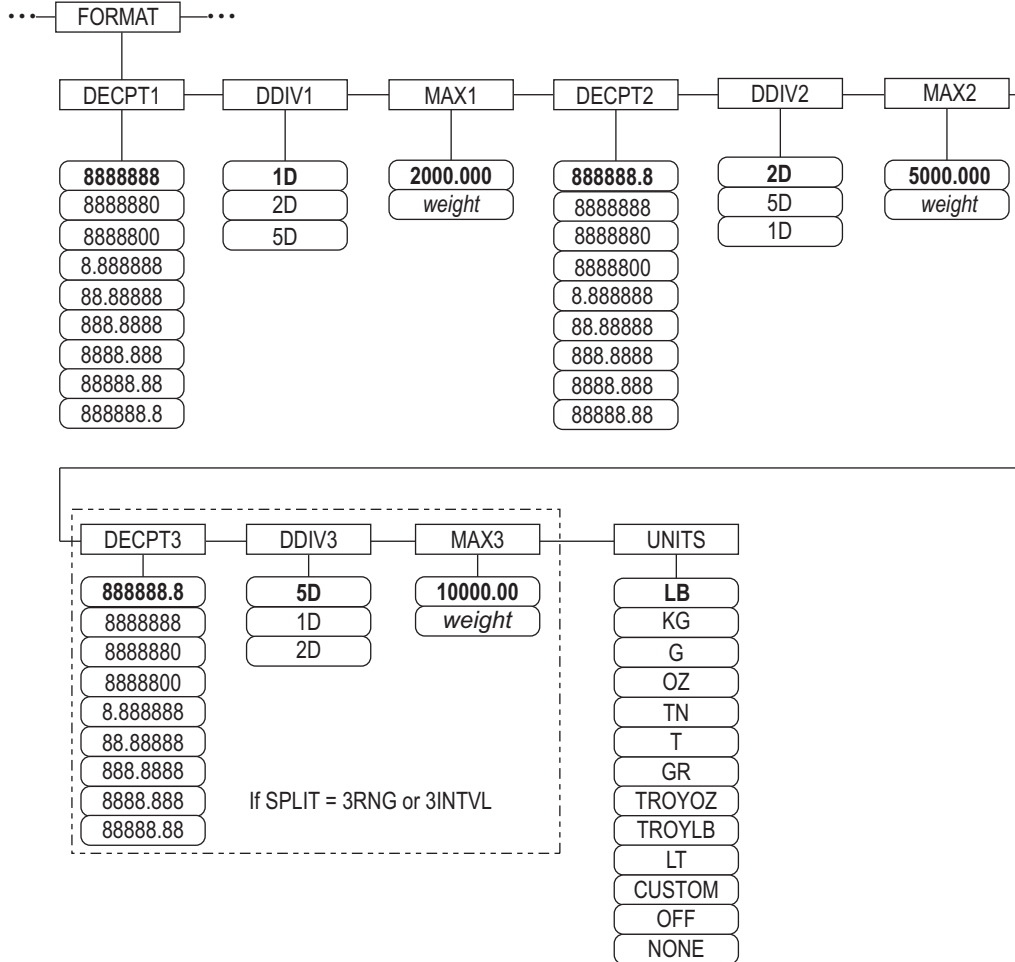

Figure 4-7. Format Menu, SPLIT ≠ OFF – 2 or 3 RNG, 2-3 INTVL

Parameter	Descriptions
DECPNT 1-3	Decimal Point Location – Specifies the location of the decimal point or dummy zeros in the unit display; Value should be consistent with local legal requirements; Settings 8888888-888888.8; Defaults: 8888888 (DDIV1), 888888.8 (DDIV2 and DDIV3) NOTE: Decimal point location for third range or interval (SPLIT = 3RNG or 3INTVL only).
DDIV 1-3	Display Divisions – For range or interval; Selects the minimum division size for the primary units displayed weight; Settings: 1D (DDIV1 Default), 2D (DDIV2 Default), 5D (DDIV3 Default); NOTE: Display divisions for third range or interval (SPLIT = 3RNG or 3INTVL only).
MAX 1-3	Maximum weight for first range or interval; Setting: weight, 50.00000 (default) NOTE: Maximum weight for third range or interval (SPLIT = 3RNG or 3INTVL only).
UNITS	Units for displayed and printed weight; Values are: LB = pound (default); KG = kilogram; G = gram; OZ = ounce; TN = short ton; T = metric ton; GR = grain; TROYOZ = troy ounce; TROYLB = troy pound; LT = long ton, Custom, None, Off

Table 4-6. Format Menu, SPLIT ≠ OFF

4.6.4 Calibration Menu

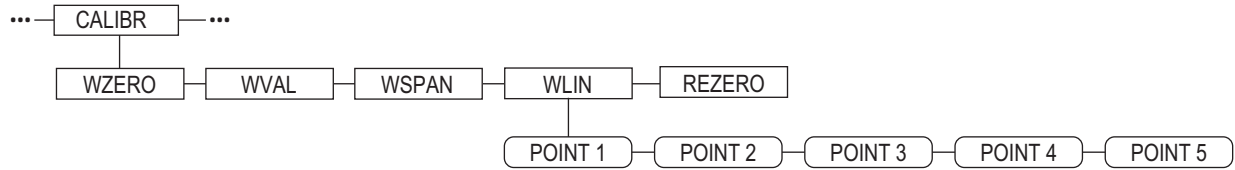

Figure 4-8. Calibration Menu

Parameter	Descriptions
WZERO	Press Enter to display and edit the zero calibration A/D raw count or millivolts value
WVAL	Press Enter to display and edit the test weight value
WSPAN	Press Enter to display and edit the span calibration A/D count or millivolts value
WLIN	Press Enter to display and edit test weight and calibration values for up to five linearization points; Perform linear calibration only after WZERO and WSPAN have been set; Settings: POINT 1 — POINT 5
REZERO	Press Enter to remove an offset value from the zero and span calibrations NOTE: Use this parameter only after WZERO and WSPAN have been set.

Table 4-7. Calibration Menu Parameters

For information on configuring an iQUBE² scale, see the iQUBE² Installation Manual (PN 106113).

4.7 Serial Menu

See [Section 13.2 on page 128](#) for information on serial data formats.

4.7.1 Ports

Parameter	Descriptions
PORT 1 PORT 2 Serial PORT 3 PORT 4 ... PORT x	Specifies the type of data received by the port: <ul style="list-style-type: none"> • CMD: ----- Remote command input • PROGIN: ----- Input routed to user program instead of core • SCALE:----- Legal-for-trade serial scale input (ports 3 and higher only) • IND SC: ----- Industrial (non-legal-for-trade) scale input (ports 3 and higher only) • DISPLAY: ----- Display data input for remote units in local/remote configurations (ports 3 and higher only) • IQUBE²: ----- iQUBE² serial scale input (ports 3 and higher only); See the iQUBE² Installation Manual (PN 106113) • INCLIN:----- Special mode for use with Rice Lake inclinometer (port 1 only) • KEYBD: ----- Remote keyboard input (PS/2) (port 2 only) • KBDPRG: ----- Remote keyboard input for user programs (PS/2) (port 2 only)
PORT 2 USB	Specifies the type of data received by the port: NOTE: These selections for port 2 are available only if the USB interface card is installed. <ul style="list-style-type: none"> • DEVICE: ----- Sets target USB device to use: AUTO, NODEVICE, HOSTPC, PRINTER1, PRINTER2, KEYBOARD, or DRIVE • TERMIN:----- Indicates whether files have CR/LF (Windows) or CR (Macintosh previous to OS X) as the line terminator • ECHO: ----- Specifies whether characters received by the port are echoed back to the sending unit • RESPONSE: ---- Specifies whether the port transmits replies to serial commands • EOLDLY: ----- End-of-line delay; sets the delay period, in 0.1-second intervals, from when a formatted line is terminated to the beginning of the next formatted serial output • STREAM: ----- Specifies what data, if any, is streamed from the port • INPUT: ----- Determines whether the input will be handled by the core or routed to a user program (if present)

Table 4-8. Serial Menu – Port Parameters

4.7.2 Port 1

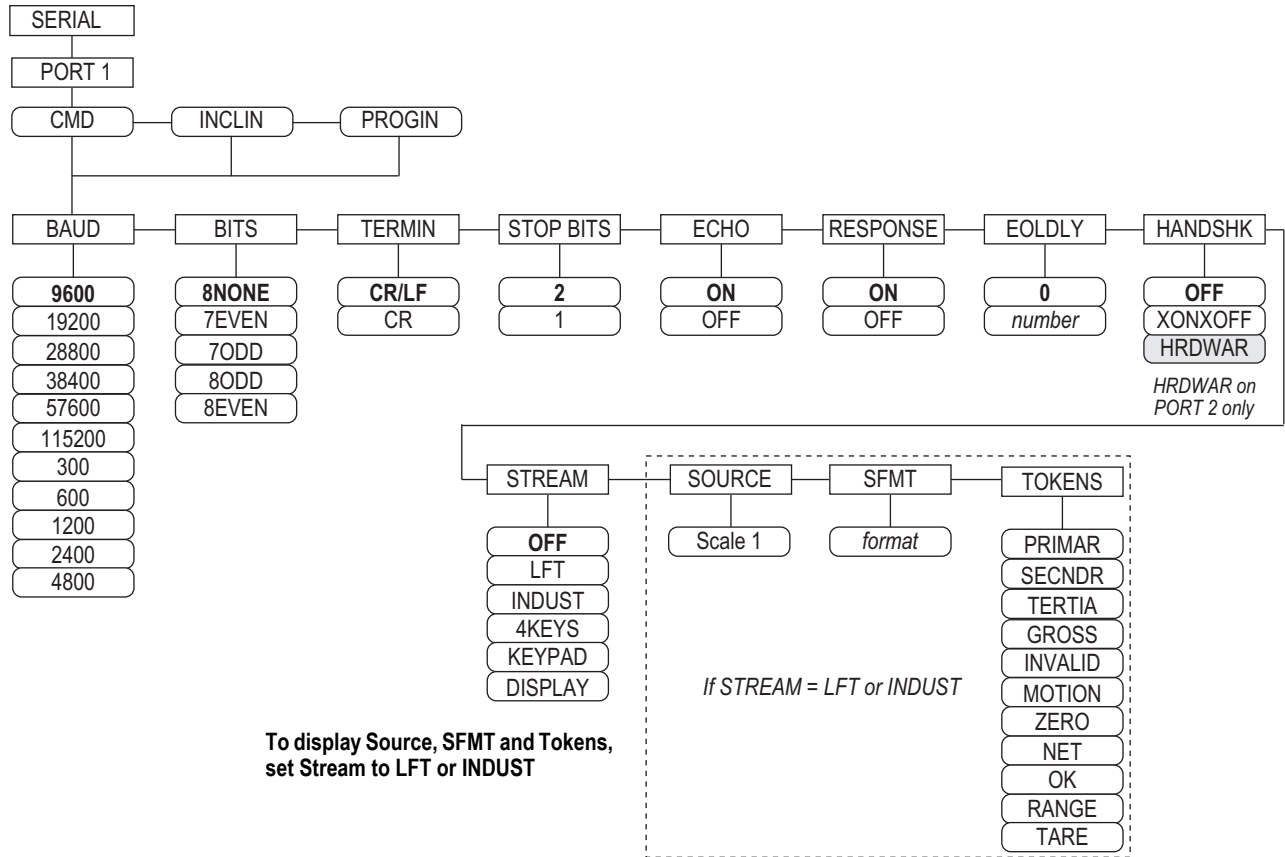

Figure 4-9. Serial Menu, Port 1 Menu Layout

4.7.3 Port 2 with Serial Interface Option

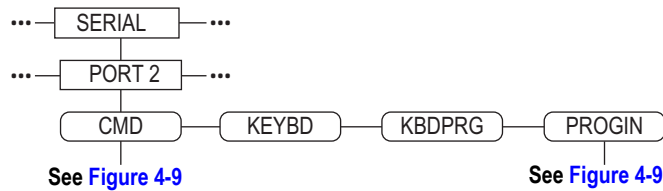

Figure 4-10. Port 2 (with Serial Interface Option) Menu Layout

4.7.4 Port 2 with USB Interface Option

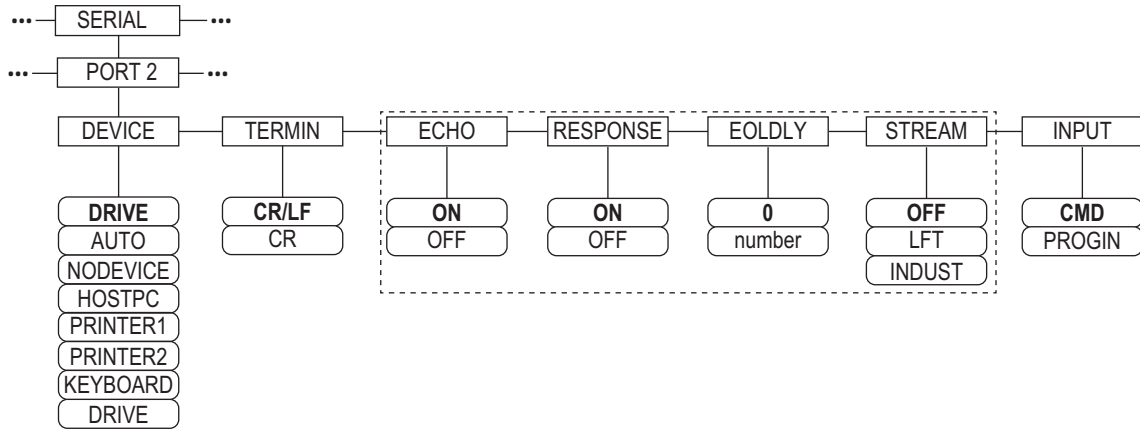

Figure 4-11. Port 2 (with USB Interface Option) Menu Layout

Device	Menu Parameters
DRIVE	TERMIN, INPUT, DEVICE
AUTO	TERMIN, ECHO, RESPONSE, EOLDLY, STREAM, INPUT, DEVICE; If STREAM is set to LFT or INDUST, SOURCE, SFMT and TOKENS display after STREAM
NODEVICE	No parameters available
HOSTPC	TERMIN, ECHO, RESPONSE, EOLDLY, STREAM, INPUT, DEVICE; If STREAM is set to LFT or INDUST, SOURCE, SFMT and TOKENS display after STREAM
PRINTER1	TERMIN, EOLDLY, STREAM; If STREAM is set to LFT or INDUST, SOURCE, SFMT and TOKENS display after STREAM
PRINTER2	TERMIN, EOLDLY, STREAM; If STREAM is set to LFT or INDUST, SOURCE, SFMT and TOKENS display after STREAM
KEYBOARD	INPUT, DEVICE

Table 4-9. Menu Parameters for Device Selected

4.7.5 Port 3 and 4 Menu Structure

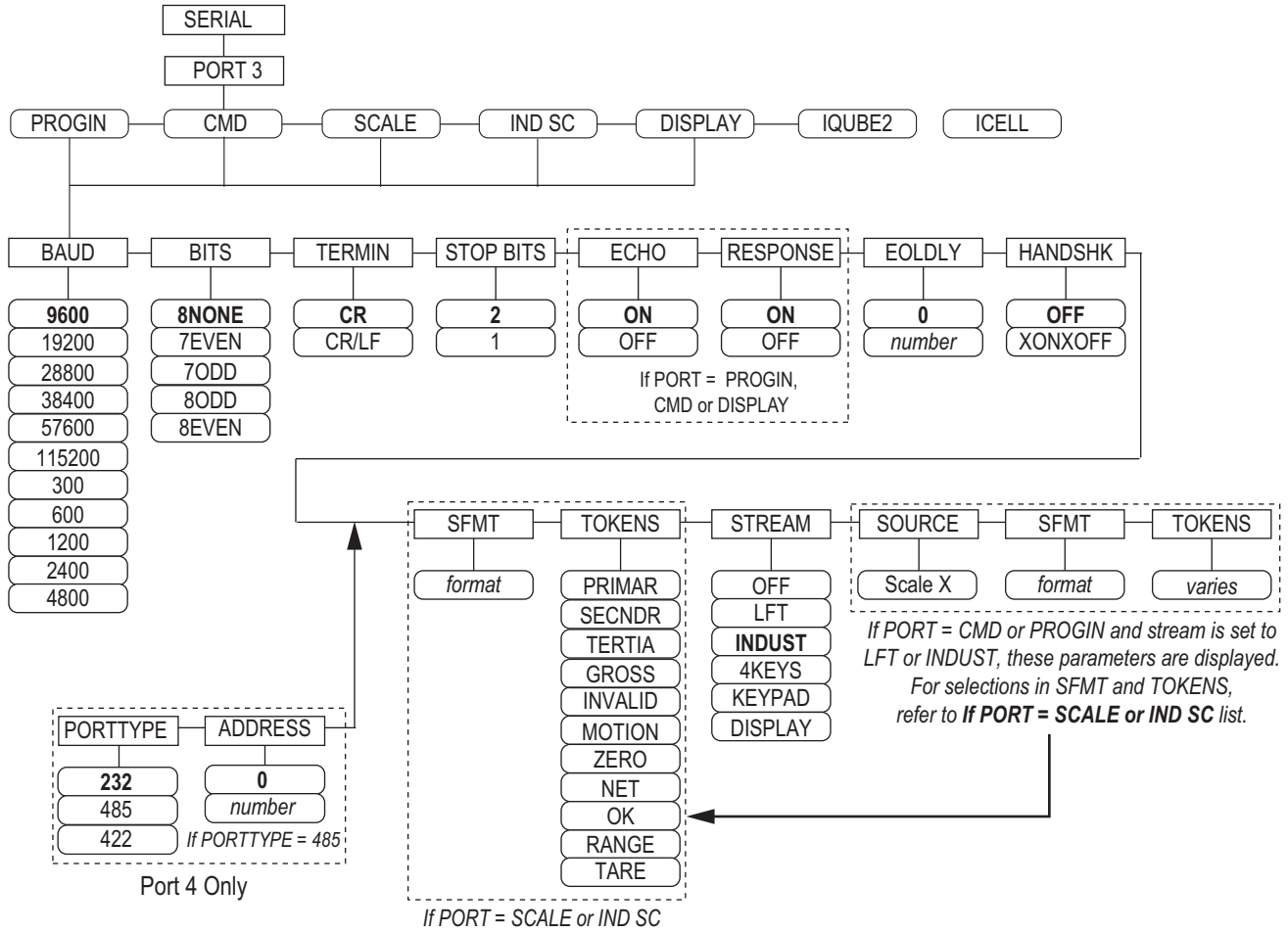

Figure 4-12. Port 3 & 4 Menu Layout

Port	Menu Parameters
PROGIN	BAUD, BITS, TERMIN, STOP BITS, ECHO, RESPONSE, EOLDLY, HANDSHK, PORTTYPE (Port 4 Only), STREAM If STREAM is set to LFT or INDUST – SOURCE, SFMT, TOKENS display after STREAM
CMD	BAUD, BITS, TERMIN, STOP BITS, ECHO, RESPONSE, EOLDLY, HANDSHK, PORTTYPE (Port 4 Only), STREAM If STREAM is set to LFT or INDUST – SOURCE, SFMT, TOKENS display after STREAM
SCALE	BAUD, BITS, TERMIN, STOP BITS, EOLDLY, HANDSHK, SFMT, TOKENS, PORTTYPE (Port 4 Only), STREAM
IND SC	BAUD, BITS, TERMIN, STOP BITS, EOLDLY, HANDSHK, SFMT, TOKENS, PORTTYPE (Port 4 Only), STREAM
DISPLAY	BAUD, BITS, TERMIN, STOP BITS, ECHO, RESPONSE, EOLDLY, HANDSHK, PORTTYPE (Port 4 Only), STREAM
iQUBE ²	CONFIG, COMM SEL UPDATE

Table 4-10. Port 3 and 4 Menu Parameters

Parameter	Descriptions
BAUD	Baud Rate – Select transmission speed for port; Settings: 9600 (default), 19200, 28800, 38400, 57600, 115200, 300, 600, 1200, 2400, 4800 NOTE: The baud rate for ports 1–8 can be set at 115000 baud. The maximum baud rate for ports on serial expansion cards (port number greater than 8) is 19200.
BITS	Data Bits – Selects number of data bits and parity of data transmitted or received by the port; Settings: 8NONE (default), 7EVEN, 7ODD, 8ODD, 8EVEN
DEVICE (Port 2 - only with USB)	Device – Selects the target USB device to be used; Settings: <ul style="list-style-type: none"> AUTO – Automatically detects the device (default) NODEVICE – Used for iRite programming and for safely removing a flash drive HOSTPC – Used when connecting directly to a PC; The PC will automatically assign a virtual comm port PC – Settings to determine which port is assigned PRINTER1 – Used if one printer is connected PRINTER2 – Used only if a USB hub is connected; Allows more than one Type-B connection; Lowest printer ID# is Printer1 KEYBOARD – Supports USB keyboards DRIVE – Supports USB 2.0 flash drives formatted to the FAT-32 or FAT-16 file system up to 4 GB maximum
ECHO	Echo – Specifies if characters received by the port are echoed back to the sending unit; settings ON (default), OFF
EOLDLY	End-of-Line Delay – Sets the delay period, in 0.1 second intervals, from when a formatted line is terminated to the beginning of the next formatted serial output; Value is displayed in tenths of a second (10 = 1 second); Enter value: 0–255, 0 (default)
HANDSHK	Handshaking – Specifies whether XON/XOFF flow control characters or hardware handshaking (available only on Port 2) is used; Settings: OFF (default), XONOFF, HRDWAR
PORTTYPE	Port Type – Specifies what Port 4 is used for; If 485 is selected, follow the prompts to specify RS-485 address (Table 4-12); Settings: 232 (default), 485, 422 NOTE: RS-485 communications is compatible with iQUBE². It can be specified for Port 4, and for odd numbered expansion ports 5 and higher.
RESPONSE	Response – Sets the port to transmits replies to serial commands; Settings: ON (default) OFF
SFMT	Stream Format – Used for streamed data (SCALE or IND SC scale types); Consolidated Controls format is default; See Section 13.4 on page 132 for other formats; See Section 4.7.8 on page 44 custom stream formatting
SOURCE	Source – Specifies the source scale for data streamed from the port, if STREAM is set to LFT or INDUST
STOP BITS	Stop Bite – Selects number of stop bits transmitted or received by the port; settings: 2 (default), 1
STREAM	Stream – Specifies what data, if any, is streamed from the port; Settings: <ul style="list-style-type: none"> OFF ----- no streaming LFT ----- streams data at the display rate specified by the DSPRATE parameter INDUST ----- streams data at the A/D update rate specified by the SMPRATE parameter NOTE: Streaming is not supported for RS-485 connections.
TERMIN	Termination Character – Selects termination character for data sent from the port; Settings: CR/LF (default), CR
TOKENS	TOKENS – (if STREAM is set to LFT or INDUST) Parameter can be used to replace tokens used in the data stream from the indicator front panel; See Section 4.7.8 on page 44 for more information about custom stream formatting; Settings: PRIMAR, SECNDR, TERTIA, GROSS, INVALID, MOTION, ZERO, NET, OK, RANGE, TARE

Table 4-11. Port 1–Port 32 Menu Parameters

4.7.6 RS-485 Port Parameters

Parameter	Descriptions
DUPLEX	Duplex – Sets the RS-485 communications; Settings: HALF (default), FULL
ADDRESS	Address – Sets the decimal indicator address for RS-485 connections; Enter value: 0–255, 0 (default) RS-232 communications is disabled if an address other than zero is specified for this parameter

Table 4-12. RS-485 Port Parameters

4.7.7 Local/Remote Operation

For truck scale and similar applications, local/remote support provides function equivalent to that of a Legal for Trade remote display with keypad. Scale data from the local indicator is also displayed at the remote unit, and keypad input from the remote allows transactions to be initiated from either the local or remote unit.

To configure for local/remote operation, first set up the local scale (including softkey assignments, truck mode, and database information, as required). Use the SERIAL menu, serial commands, or iRev to set the Local Unit serial parameters shown in [Table 4-13](#). Configure the remote indicator using the serial parameters listed for the Remote Unit.

Serial Configuration Parameter	Parameter Value	
	Local Unit	Remote Unit
EDP.INPUT# <i>p</i>	CMD	DISPLAY
EDP.STREAM# <i>p</i>	DISPLAY	KEYPAD
EDP.BAUD# <i>p</i>	115200 preferred; local and remote values must match	
EDP.ECHO# <i>p</i>	OFF	OFF
EDP.RESPONSE# <i>p</i>	OFF	ON
# <i>p</i> = port number		

Table 4-13. Local/Remote Configuration Parameters

4.7.8 Custom Stream Formatting

Each port can be independently configured to stream a default frame format or can be customized to stream a user-defined format. Custom formatting is very similar to the standard print formatting described in [Section 8.0 on page 75](#).

[Table 4-14](#) lists the format identifiers used to configure a custom stream format.

Format Identifier	Defined By	Descriptions
<P[G N T]>	STR.POS# <i>n</i> STR.NEG# <i>n</i>	Polarity – Specifies positive or negative polarity for the current or specified (Gross/Net/Tare) weight on the source scale; Possible values are SPACE, NONE, + (for STR.POS# <i>n</i>), or – (for STR.NEG# <i>n</i>)
<U[P S T]>	STR.PRI# <i>n</i> STR.SEC# <i>n</i> STR.TER# <i>n</i>	Units – Specifies primary, secondary, or tertiary units for the current or specified weight on the source scale
<M[G N T]>	STR.GROSS# <i>n</i> STR.NET# <i>n</i> STR.TARE# <i>n</i>	Mode – Specifies gross, net, or tare weight for the current or specified weight on the source scale
<S>	STR.MOTION# <i>n</i> STR.RANGE# <i>n</i> STR.OK# <i>n</i> STR.INVALID# <i>n</i> STR.ZERO# <i>n</i>	Status for the source scale; Default values and meanings for each status: <ul style="list-style-type: none"> • STR.MOTION# <i>n</i> - MIn motion • STR.RANGE# <i>n</i> - OOut of range • STR.OK# <i>n</i> - <space>OK • STR.INVALID# <i>n</i> - IInvalid • STR.ZERO# <i>n</i> - ZCOZ
<B [-]n,...>	Bit fields; Comma-separated sequence of bit field specifiers; Must be exactly 8 bits; minus sign ([-]) inverts the bit	
B0	—	Always 0
B1	—	Always 1
B2	Configuration	=1 if even parity
B3	Dynamic	=1 if MODE=NET
B4	Dynamic	=1 if COZ
B5	Dynamic	=1 if standstill
B6	Dynamic	=1 if gross negative
B7	Dynamic	=1 if out of range
B8	Dynamic	=1 if secondary/tertiary
B9	Dynamic	=1 if tare in system
B10	Dynamic	=1 if tare is keyed

Table 4-14. Custom Stream Format Identifiers

Format Identifier	Defined By	Descriptions
B11	Dynamic	=00 if MODE=GROSS =01 if MODE=NET =10 if MODE=TARE =11 (not used)
B12	Dynamic	=00 if UNITS=PRIMARY =01 if UNITS=SECONDARY =10 if UNITS=TERTIARY =11 (not used)
B13-B16	Configuration	=00 (not used) =01 if current DSPDIV=1 =10 if current DSPDIV=2 =11 if current DSPDIV=5
B17-B19	Configuration	=000 if current DECPNT=8888800 =001 if current DECPNT=8888880 =010 if current DECPNT=8888888 =011 if current DECPNT=888888.8 =100 if current DECPNT=88888.88 =101 if current DECPNT=8888.888 =110 if current DECPNT=888.8888 =111 if current DECPNT=88.88888
B20	Configuration	=000 if tertiary DECPNT=8888800 =001 if tertiary DECPNT=8888880 =010 if tertiary DECPNT=8888888 =011 if tertiary DECPNT=888888.8 =100 if tertiary DECPNT=88888.88 =101 if tertiary DECPNT=8888.888 =110 if tertiary DECPNT=888.8888 =111 if tertiary DECPNT=88.88888
<wspec [-] [0] digit[.].digit>	Scale weight	Weight for the source scale. wspec is defined as follows: <ul style="list-style-type: none"> • wspec indicates if the weight is the current displayed weight (W, w), gross (G, g), net (N, n), or tare (T, t) weight; Upper-case letters specify right-justified weights; lower-case specify left-justified • Optional /P, /S, or /T suffixes can be added before the ending delimiter (>) to specify weight display in primary (/P), secondary (/S), or tertiary (/T) units • [-] Enter a minus sign (-) to include sign for negative values • [0] Enter a zero (0) to display leading zeros • digit[.].digit <p>The first digit indicates the field width in characters; Decimal point only indicates floating decimal; Decimal point with following digit indicates fixed decimal with n digits to the right of the decimal; Two consecutive decimals send the decimal point even if it falls at the end of the transmitted weight field</p>
<CR>	—	Carriage return
<LF>	—	Line feed

Table 4-14. Custom Stream Format Identifiers (Continued)

4.8 Feature Menu

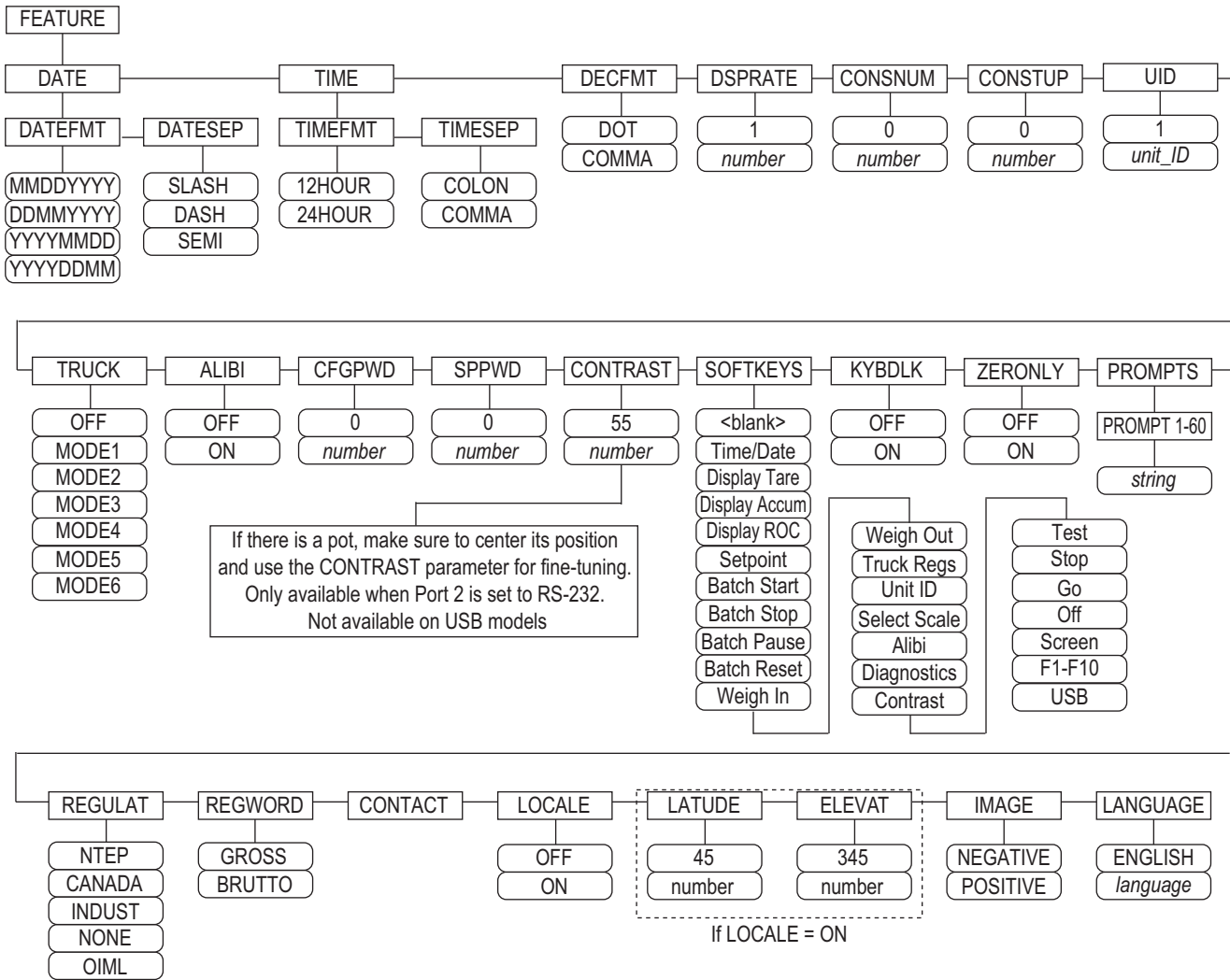

Figure 4-13. Feature Menu

Parameter	Descriptions
DATE	Date Format – Set date format and date separator character; Settings: DATEFMT, DATESEP; Use the Time/Date softkey or the SD serial command to set the date
TIME	Time Format – Set time format and separator character; Settings: TIMEFMT, TIMESEP; Use the Time/Date softkey or the ST serial command to set the time
DECFMT	Decimal Format – Set decimal symbol; Settings: DOT, COMMA
DSPRATE	Display Update Rate – Set display update rate, in number of 100-millisecond intervals between updates; Enter value: 1–80, 1 (default) <i>Example: 1 provides about 10 updates per second, the maximum value updates the display every 8 seconds</i>
CONSNUM	Consecutive Numbering – Allows sequential numbering for print operations; The consecutive number value is incremented following each print operation including <CN> in the ticket format; When the consecutive number is reset, it is reset to the value specified on the CONSTUP parameter; Enter value: 0–9999999, 0 (default)
CONSTUP	Specifies the consecutive number start-up value used when the consecutive number is reset by sending the KCLRCN serial command or a CLRCN digital input; Enter value: 0–9999999, 0 (default)
UID	Unit Identification Number – Value specified can be any alphanumeric value, up to eight characters; this number is also used as a folder name when the USB file system is used; Enter value: unit-ID, 1 (default)

Table 4-15. Feature Menu Parameters

Parameter	Descriptions
TRUCK	Truck Mode – If selected, the indicator switches from normal mode to the selected truck mode; Settings: OFF (default) MODE1: Auto clear ID, keyed tares, value swapping MODE2: Auto clear ID, no keyed tares, value swapping MODE3: Stored ID, keyed tares, value swapping MODE4: Stored ID, no keyed tares, value swapping MODE5: Stored ID, keyed tares, no value swapping MODE6: Stored ID, no keyed tares, no value swapping See Section 9.0 on page 82 for more information about using the truck modes
ALIBI	Alibi Feature – Specifies if data storage is used to allow reprinting of any transaction; Settings: OFF (default), ON; Use the softkey parameter to set a softkey to recall alibi for print transactions
CFGPWD	Configuration Password – Specify a non-zero value to restrict access to all configuration menus; Enter value: 0–9999999, 0 (default); To clear the indicator: press the setup switch, enter 999999 at the configuration password prompt; unit performs a RESETCONFIGURATION and returns to configuration mode display NOTE: Record the password and keep it in a safe place; if lost or unavailable, the indicator must be cleared (reset configuration and calibration parameters) to continue use
SPPWD	Setpoint Password – Set a value, above zero, to restrict access to the setpoint menu; It is shared by and can be used to protect the truck register; If a setpoint password is specified, the password must be entered before deleting entries from the truck register; Enter value: 1–9999999, 0 (indicates no password is in place)
CONTRAST	Contrast Level – Adjusts contrast of display; a Contrast softkey can be set; enter value: 0–127, 55 (default)
SOFTKEYS	Use the Add and Remove softkeys to set softkeys to be displayed in weighing mode; Settings: <blank>, Time/Date, Display Tare, Display Accum, Display ROC, Setpoint, Batch Start, Batch Stop, Batch Pause, Batch Reset, Weigh In, Weigh Out, Truck Regs, Unit ID, Select Scale, Alibi, Diagnostics, Contrast, Test, Stop, Go, Off, Screen, F1–F10, USB
KYBDLK	Keyboard Lock – Disables the keypad in normal mode; Settings: OFF (default), ON
ZERONLY	Zero Key Only – Disables all front panel keys except ZERO in normal mode; Settings: OFF (default), ON
PROMPTS	Prompts – For use in setpoint names; Prompts are referenced by the NAME parameter under the SETPTS menu; Prompts can be shown on the display during setpoint execution; Settings: PROMPT 1-60
REGULAT	Regulatory Mode – Specifies the regulatory agency having jurisdiction over the scale site <ul style="list-style-type: none"> • OIML, NTEP, and CANADA modes allow a tare to be acquired at any weight greater than zero; NONE allows tares to be acquired at any weight value • OIML, NTEP, and CANADA modes allow a tare to be cleared only if the gross weight is at no load; NONE allows tares to be cleared at any weight value • NTEP and OIML modes allow a new tare to be acquired even if a tare is already present; In CANADA mode, the previous tare must be cleared before a new tare can be acquired • NONE, NTEP and CANADA modes allow the scale to be zeroed in either gross or net mode as long as the current weight is within the specified ZRANGE; In OIML mode, the scale must be in gross mode before it can be zeroed; Pressing the ZERO key in net mode clears the tare • INDUST provides a set of sub-parameters to allow customization of tare, clear, and print functions in non Legal-for-Trade scale installations (Section 4.8.2 on page 49) The value specified for this parameter affects the function of the front panel Tare and Zero keys; See Table 4-19 on page 50 for a complete description of Tare and Zero key functions for each of the regulatory modes
REGWORD	Regulation Word – Sets the term displayed when weighing in gross mode; Settings: GROSS (default) BRUTTO
CONTACT	Contact – Allows specification of contact information for use in iQUBE ² alert messages (Table 4-17 on page 48)
LOCALE	Locale – Enables the LATUDE and ELEVAT parameters; Specifying latitude and elevation of the scale site provides compensation for gravitational effects; Settings: OFF (default), ON NOTE: Attached scales must be re-calibrated after changing this parameter from OFF to ON; Gravitational compensation settings do not affect iQUBE² scales.
LATUDE	Latitude – Specify the latitude of the scale site in degrees; Only displayed if LOCALE=ON; Enter value: 0–90°, 45° (default)
ELEVAT	Elevation – Specify the elevation of the scale site in meters; Enter value: -9999–9999; Only displayed if LOCALE=ON; Enter value: -9999–9999 m, 345 m (default)
IMAGE	Image – Specifies if the indicator display is presented as blue-on-white or white-on-blue; Settings: <ul style="list-style-type: none"> • Negative (default) – Displays blue-on-white when using the stock LCD display, the optional outdoor display uses white-on-blue • Positive – When using the outdoor display, blue-on-white displays, use the LCD contrast potentiometer to adjust for optimal viewing
LANGUAGE	Language – Set the language and character set used for prompts and printing; Settings: ENGLISH (default), language

Table 4-15. Feature Menu Parameters (Continued)

Parameter	Descriptions
DATEFMT	Specifies the format used to display or print the date; Settings: MMDDYYYY (default), DDMMYYYY, YYYYMMDD, YYYYDDMM
DATESEP	Specifies the date separator character; Settings: SLASH (default), DASH, SEMI
TIMEFMT	Specifies the format used to display or print the time; Settings: 12HOUR (default), 24HOUR
TIMESEP	Specifies the time separator character; Settings: COLON (default), COMMA

Table 4-16. Date and Time Format Parameters

4.8.1 Contact Menu

The contact menu allows entry of contact information.

- Display contact information, in setup mode, by entering the Version menu and pressing the **Contacts** softkey
- Display contact information, in weigh mode, by pressing the **Diagnostics** softkey
- Contact information may be used in print formats ([Section 8.0 on page 75](#))

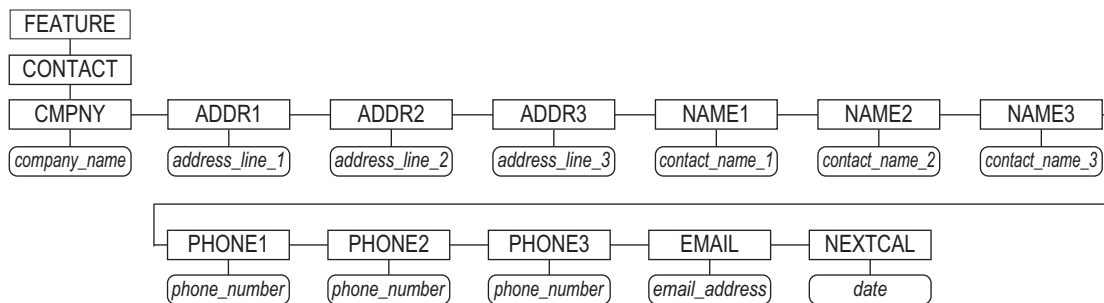

Figure 4-14. Contact Menu

Parameter	Descriptions
CMPNY	Company Name – Enter the name of the contact company or dealer
ADDR1–ADDR3	Address – Enter up to three lines of address information for the contact company
NAME1–NAME3	Name – Enter names of up to three contact persons
PHONE1–PHONE3	Phone – Enter phone numbers for each of the contact persons specified for the NAME_x parameter
EMAIL	Email – Enter the email address of the contact company or dealer; If the iQUBE ² alert support is used to send automated alert email messages, enter email address to send messages to; See the iQUBE ² Installation Manual (PN 106113) for more information
NEXTCAL	Next Calibration – Enter the next scheduled calibration date using the month/day/year format of the DATEFMT parameter; Separator characters are not required

Table 4-17. Contact Menu Parameters

4.8.2 Regulatory/Industrial Menu

The Industrial setting of the Regulation parameter allows customization of several tare, clear, and print functions for use in non Legal for Trade scale installations. See [Section 4.8.3 on page 50](#) for more information about regulatory mode functions.

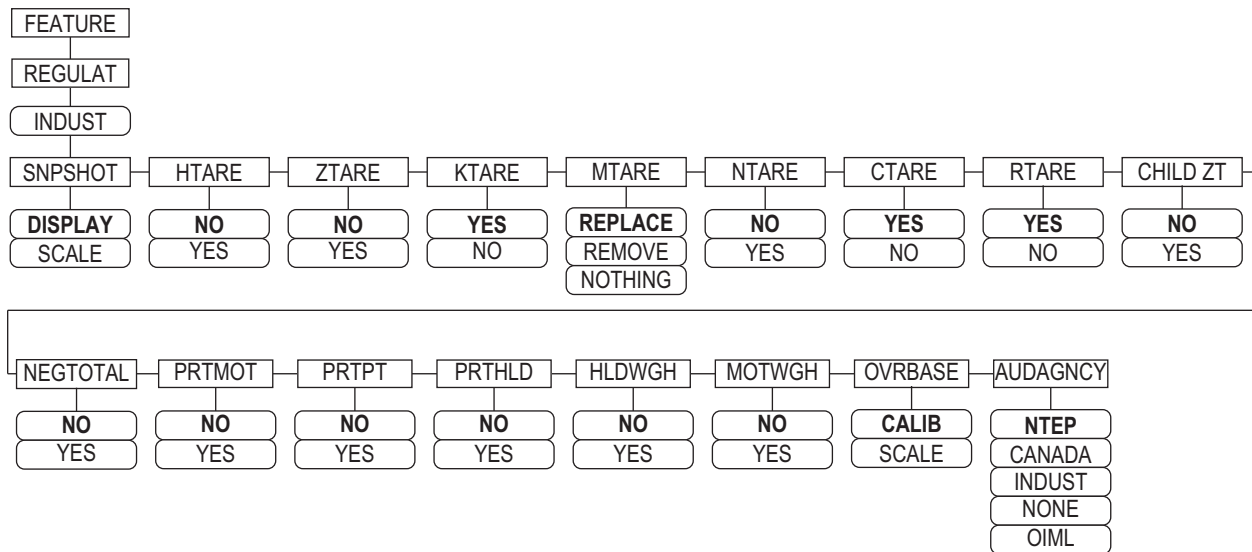

Figure 4-15. Regulatory/Industrial Menu Layout

Parameter	Descriptions
SNPSHOT	Snap Shot – Display or scale weight source; Settings: DISPLAY (default), SCALE
HTARE	Hold Tare – Allow tare in display hold; Settings: NO (default), YES
ZTARE	Zero Tare – Remove tare on Zero ; Settings: NO (default), YES
KTARE	Keyed Tare – Always allow keyed tare; Settings: YES (default), NO
MTARE	Multiple Tare – Replaces existing Tare when the Tare key is pressed; Settings: Replace (default), Remove Nothing
NTARE	Negative Tare – Allow negative or zero tare; Settings: NO (default), YES
CTARE	Clear Tare – Allow Clear key to clear tare/accumulator; Settings: YES (default), NO
RTARE	Round Tare – Round semi-automatic (pushbutton) tare to the nearest display division; Settings: YES (default), NO
CHILD ZT	Child Zero Tare – Clear child scales individually; Settings: NO (default), YES
NEGTOTAL	Negative Total – Allow total scale to display negative value; Settings: NO (default), YES
PRTMOT	Print Motion – Allow print while in motion; Settings: NO (default), YES
PRTPT	Print Preset Tare – Add PT to keyed tare print; Settings: NO (default), YES
PRTHLD	Print Hold – Print during display hold; Settings: NO (default), YES
HLDWGH	Hold Weighment – Allow truck weighment during display hold; Settings: NO (default), YES
MOTWGH	Motion Weighment – Allow truck weighment in motion; Settings: NO (default), YES
OVRBASE	Over Base – Sets an industrial scale to function like an OIML or NTEP scale (Table 4-20 on page 50); Settings: CALIB (default), SCALE
AUDAGNCY	Audit Agency – Audit trail display agency format; Settings: NTEP (default), CANADA, INDUST, NONE, OIML

Table 4-18. Regulatory/Industrial Menu Parameters

4.8.3 Regulatory Mode Functions

The function of the front panel **Tare** and **Zero** keys depends on the value specified for the **REGULAT** parameter on the Feature menu. [Table 4-19](#) describes the function for the NTEP, CANADA, OIML, and NONE regulatory modes. **Tare** and **Zero** key functions are configurable when the REGULAT mode is set to INDUST.

REGULAT Parameter Value	Weight on Scale	Tare in System	Front Panel Key Function	
			TARE	ZERO
NTEP	Zero or negative	No	No action	ZERO
		Yes	CLEAR TARE	
	Positive	No	TARE	
		Yes	TARE	
CANADA	Zero or negative	No	No action	ZERO
		Yes	CLEAR TARE	
	Positive	No	TARE	
		Yes	No action	
OIML	Zero or negative	No	No action	ZERO
		Yes	CLEAR TARE	ZERO and CLEAR TARE
	Positive	No	TARE	ZERO
		Yes	TARE	ZERO and CLEAR TARE • If weight is within ZRANGE • If weight is outside of ZRANGE, no action
NONE	Zero or negative	No	TARE	ZERO
		Yes	CLEAR TARE	
	Positive	No	TARE	
		Yes	CLEAR TARE	

Table 4-19. Tare and Zero Key Functions for REGULAT Parameter Settings

[Table 4-20](#) includes the default values of the INDUST sub-parameters and the effective (not configurable) values used by the NTEP, CANADA, OIML, and NONE regulatory modes.

REGULAT / INDUST Parameter		REGULAT Mode				
Parameter Name	Text Prompt	INDUST	NTEP	CANADA	OIML	NONE
SNPSHOT	Display or scale weight source	DISPLAY	DISPLAY	DISPLAY	DISPLAY	SCALE
HTARE	Allow tare in display hold	NO	NO	NO	NO	YES
ZTARE	Remove tare on ZERO	NO	NO	NO	YES	NO
KTARE	Always allow keyed tare	YES	YES	NO	YES	YES
MTARE	Multiple tare action	REPLACE	REPLACE	NOTHING	REPLACE	REMOVE
NTARE	Allow negative tare	NO	NO	NO	NO	YES
CTARE	Allow Clear key to clear tare/accumulator	YES	YES	NO	NO	YES
RTARE	Round semi-automatic (pushbutton) tare to nearest display division	YES	YES	YES	NO	YES
CHILDZT	Clear child scales individually	NO	NO	NO	NO	NO
NEGTOTAL	Allow total scale to display negative value	NO	NO	NO	NO	NO
PRTMOT	Allow print while in motion	NO	NO	NO	NO	YES
PRTPT	Add PT to keyed tare print	NO	NO	YES	YES	NO
PRTHLD	Print during display hold	NO	NO	NO	NO	YES
HLDWGH	Allow weigh during display hold	NO	NO	NO	NO	YES
MOTWGH	Allow weighment in motion	NO	NO	NO	NO	NO
OVRBASE	Zero base for overload calculation	CALIB ZERO	CALIB ZERO	CALIB ZERO	SCALE ZERO	CALIB ZERO

Table 4-20. Regulat / Indust Mode Parameters, Comparison with Effective Values of Other Modes

4.9 Print Format Menu

See [Section 8.0 on page 75](#) for information about custom print formatting.

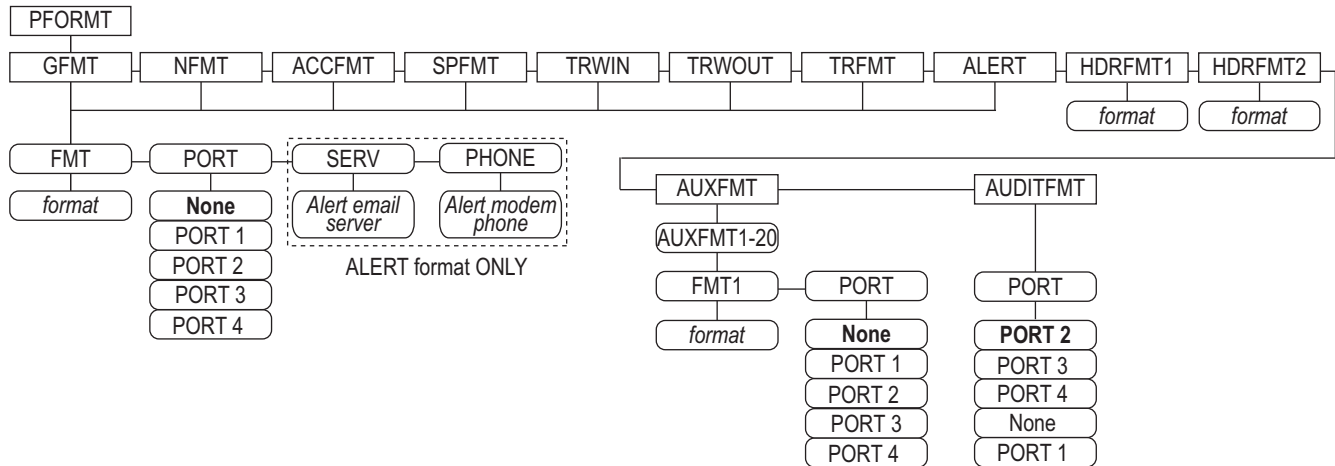

Figure 4-16. Print Format Menu

Parameter	Descriptions
GFMT	Available formats; Settings:
NFMT	
ACCFMT	
SPFMT	
TRWIN	
TRWOUT	
TRFMT	
ALERT	<ul style="list-style-type: none"> • FMT – Enter desired format • PORT – Select appropriate PORT 1-4 or NONE • SERV – Enter an email server for alerts (ALERT format only) • PHONE – Enter a phone number for alerts (ALERT format only)
HDRFMT1	Header format 1 – Enter header format
HDRFMT2	Header format 2 – Enter header format
AUXFMT	Aux format 1–20 – Enter the format and select the port as needed
AUDITFMT	Audit format – Select the port as needed

Table 4-21. Print Format Menu

4.11 Digital I/O Menu

The Digital I/O menu shown in Figure 4-18 is used to assign functions to digital inputs and outputs. SLOT 0 represents the six I/O bits available on the CPU board (connector J2); additional slots, each with 24 I/O bits, are shown only if one or more digital I/O expansion cards are installed.

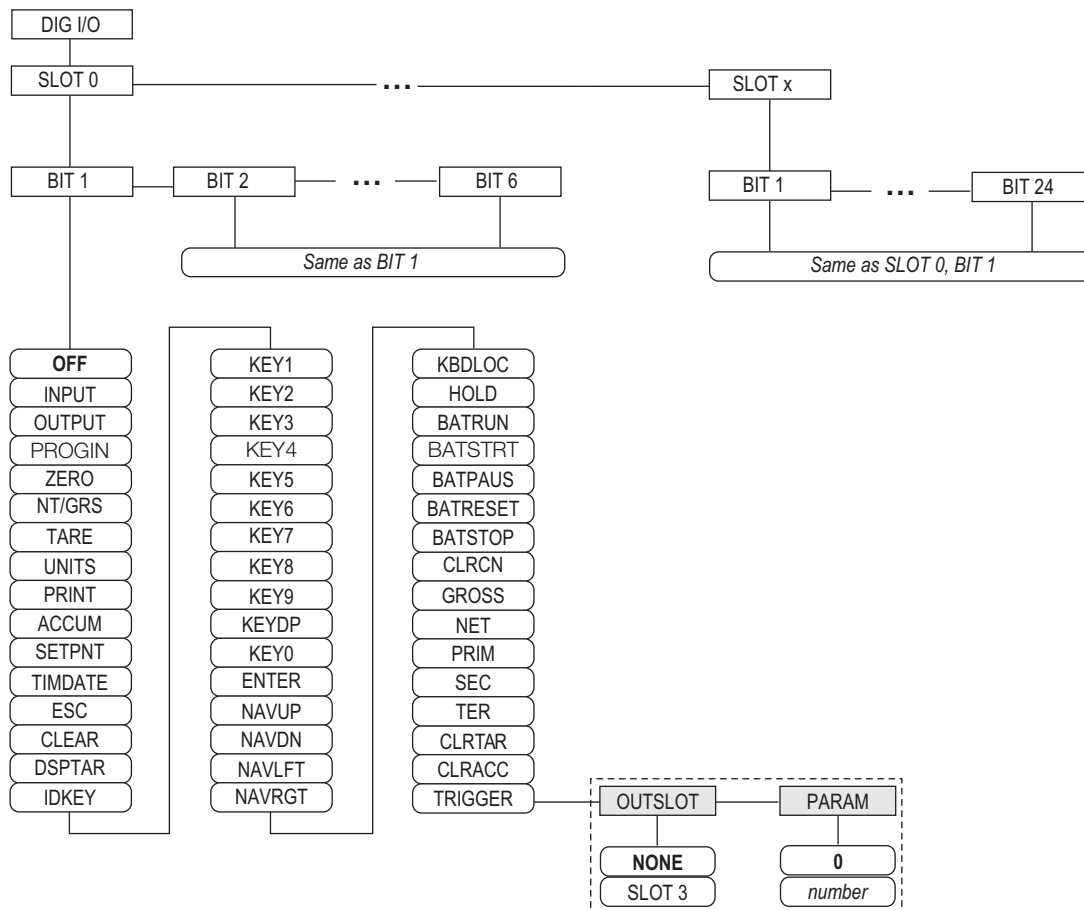

Figure 4-18. DIG I/O Menu

SLOTx – BIT n: lists available digital I/O slots.

If iQUBE² is configured on an optional serial card, that slot will also be listed for available iQUBE² digital I/O bits.

Parameter	Descriptions
OFF	Indicates that the bit is not configured
INPUT	Assigns the bit as a digital input used for DIGIN setpoints
OUTPUT	Assigns the bit as a digital output for setpoint or program use
PROGIN	Assigns the bit as a digital input used to generate a program event
ZERO	Provides the same function as the front panel ZERO key
NT/GRS	Provides the same function as the front panel NET/GROSS key (net/gross mode toggle)
TARE	Provides the same function as the front panel TARE key
UNITS	Provides the same function as the front panel UNITS key
PRINT	Provides the same function as the front panel PRINT key
ACCUM	Adds the current scale weight to the accumulator, if the scale accumulator is enabled
SETPNT	Provide the same functions as the Setpoint softkey
TIMDATE	Provide the same functions as the Time/Date softkey
ESC	Provides a function equivalent to the Cancel softkey

Table 4-22. Digital I/O Bit Parameters

Parameter	Descriptions
CLEAR	Simulates pressing the front panel CLR key
DSPTAR	Displays the current tare; equivalent to pressing the Display Tare softkey
IDKEY	Displays a prompt to enter a new unit ID; equivalent to pressing the Unit ID softkey
KEY0-9	Simulates pressing a numerical key (KEY1 = pressing the 1 key)
KEYDP	Simulates pressing the decimal point key on the numeric keypad
ENTER	Simulates pressing the front panel ENTER key
NAVUP	Simulates pressing the up arrow key
NAVDN	Simulates pressing the down arrow key
NAVLFT	Simulates pressing the left arrow key
NAVRGT	Simulates pressing the right arrow key
KBDLOC	Locks the keyboard (indicator front panel) when held low
HOLD	Holds the current display; Releasing this input clears the running average filter
BATRUN	Allows a batch routine to be started and run; With BATRUN active (low), the BATSTRT input starts the batch; If BATRUN is inactive (high), BATSTRT resets the batch
BATSTRT	Starts or resets a batch routine, depending on the state of the BATRUN input
BATPAUS	Pauses a batch routine when held low
BATRESET	Stops the batch sequence and resets to the first batch step
BATSTOP	Stops the batch routine
CLRCN	Resets the consecutive number to the value specified in the CONSTUP parameter (FEATURE menu)
GROSS	Sets display to Gross mode
NET	Sets display to Net mode
PRIM	Sets display to primary units
SEC	Sets display to secondary units
TER	Sets display to tertiary units
CLRTAR	Clears the current tare for the active scale
CLRACC	Clears the active accumulator
TRIGGER	Used for custom applications only (Table 4-23)

Table 4-22. Digital I/O Bit Parameters (Continued)

Parameter	Descriptions
OUTSLOT	Specifies the card slot receiving the trigger output; Settings: NONE (default), PORT3
PARAM	Specifies the value passed as a parameter to the option card in the specified slot; Enter value: 0 is default

Table 4-23. Digital I/O – Trigger Parameters

4.12 Analog Output Menu

The ALGOUT menu is shown only if the analog output option is installed. If the analog output option is installed, configure all other indicator functions and calibrate the indicator itself before configuring the analog output. See the Analog Output Card Installation (PN 69089) for more information.

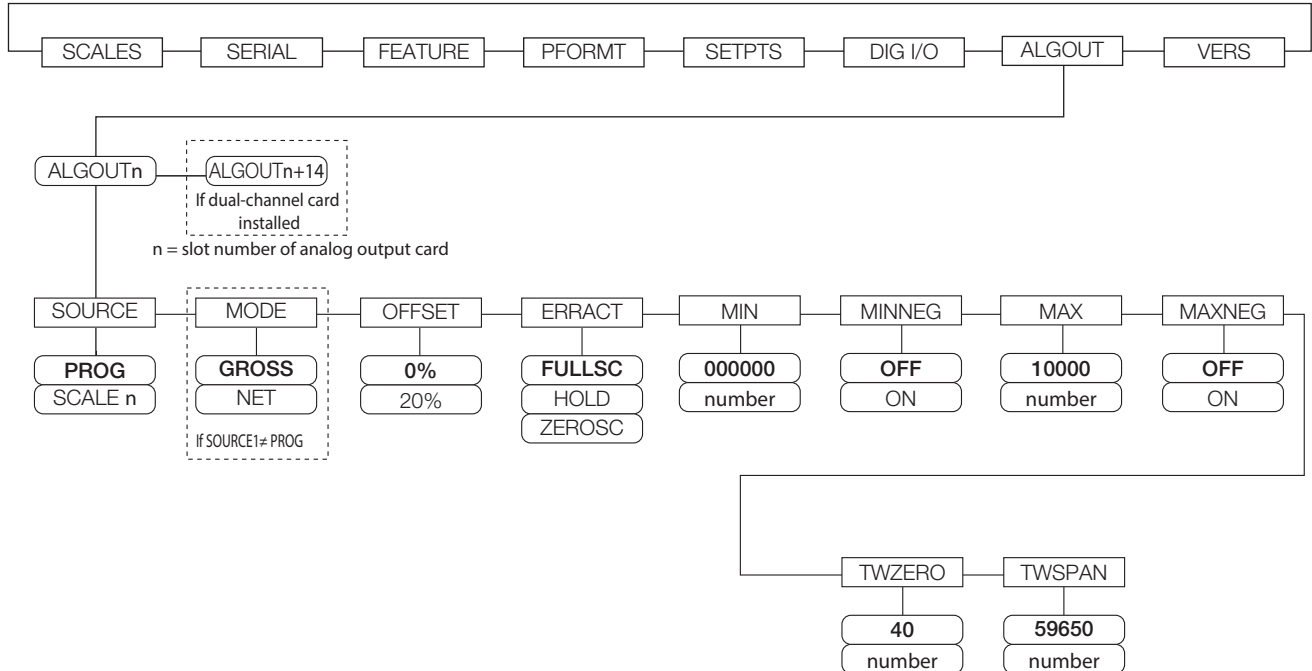

Figure 4-19. Analog Output Menu

Parameter	Descriptions
SOURCE	Source – Specifies the scale tracked by the analog output; Settings: <ul style="list-style-type: none"> • PROG (default) indicates that the analog output is under program control • SCALE_n = 1-32
MODE1	Mode – Specifies the weight data tracked by the analog output; Settings: GROSS (default), NET
OFFSET	Zero Offset – Select 0% for 0–10 V or 0–20 mA output; Select 20% (default) for 4–20 mA output; This parameter must be set before calibrating the analog output
ERRACT	Error Action – Specifies how the analog output responds to system error conditions; Settings: <ul style="list-style-type: none"> • FULLSC (default) – Set to full value (10 V or 20 mA) • HOLD – Hold current value • ZEROSC – Set to zero value (0 V or 4 mA)
MIN	Specifies the minimum weight value tracked by the analog output; Enter value: 0–9999999, 000000 (default)
MINNEG	Specify ON if the minimum weight (MIN parameter) is a negative value; Settings: OFF (default), ON
MAX	Specifies the maximum weight value tracked by the analog output; Enter value: 0–9999999, 10000 (default)
MAXNEG	Specify ON if the maximum weight (MAX parameter) is a negative value; Settings: OFF (default), ON
TWZERO	Tweak Zero – Enter tweak value to adjust the analog output zero calibration; Use a multimeter to monitor the analog output value; Enter value: 0–65535, 40 (default)
TWSPAN	Tweak Span – Enter tweak value to adjust the analog output span calibration; Use a multimeter to monitor the analog output value; Enter value: 0–65535, 59650 (default)

Table 4-24. Analog Output Menu Parameters

4.13 Fieldbus Menu

The Fieldbus menu is only displayed if a DeviceNet, PROFIBUS®, EtherNet/IP, or ControlNet option card is installed. The SWAP parameter on the FLDBUS menu enables byte swapping by the iRite BusCommand handler rather than requiring a SWP (SWAPBYTE) instruction in the PLC. Byte swapping is enabled by default for DeviceNet cards; for all other fieldbus cards, byte swapping is disabled by default.

- BYTE swaps bytes within the word before transmission to the scanner
- WORD swaps words 1 and 2, 3 and 4, within a 4-word packet
- BOTH performs both operations, swapping bytes within a word and swapping words within the packet
- NONE disables swapping

The DATASIZE parameter sets the size of the BusCommand handler data transfers. The default value (8 bytes) matches the default data size specified in the EDS and GSD files, and used by the standard discrete transfer commands. DATASIZE can be set to any value from 2–128 bytes (1–64 words), but the value specified must match the data size set for the PLC Scanner I/O data size.

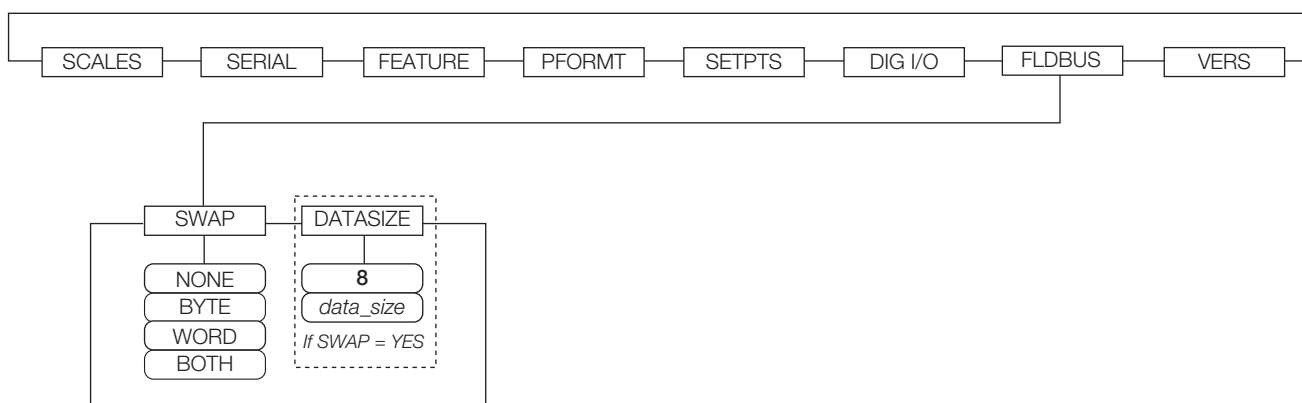

Figure 4-20. Fieldbus Menu

Parameter	Descriptions
SWAP	Specifies byte-swapping used for the fieldbus card; Settings: NONE, BYTE, WORD, BOTH (Default for DeviceNet is BYTE ; default for all other cards is NONE) NOTE: In Version 3.08 firmware, this parameter supports values of YES (byte swapping) or NO. Version 3.09 replaces YES with BYTE, NO with NONE, and adds the values WORD and BOTH.
DATASIZE	Data Size – Specifies the data size, in bytes, that the BusCommand handler transfers; Settings: 2–12, 8 (default); If parameter is set to a value other than the default (8 bytes), ensure that it matches the Scanner I/O data size specified for the PLC

Table 4-25. Fieldbus Menu Parameters

4.14 Version Menu

The Version menu can be used to check the installed software version or, by using the **Reset Config** softkey, to restore all configuration parameters to their factory default values. There are no parameters associated with the Version menu: when selected, the indicator displays the installed software version number.

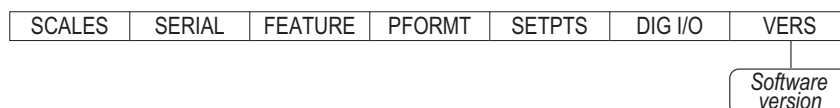

Figure 4-21. Version Menu

The **Contacts** softkey on the Version menu allows display of contact information ([Section 4.8.1 on page 48](#)).

If an iQUBE² scale is configured, a **Diagnostics** softkey also provides access to iQUBE² diagnostic information.

5.0 Calibration

The 920i can be calibrated using the front panel, serial commands or iRev.

The following sections describe the calibration procedure for each of the calibration methods.

See the iQUBE² Installation Manual (PN 106113) for information about configuring iQUBE² attached scales.

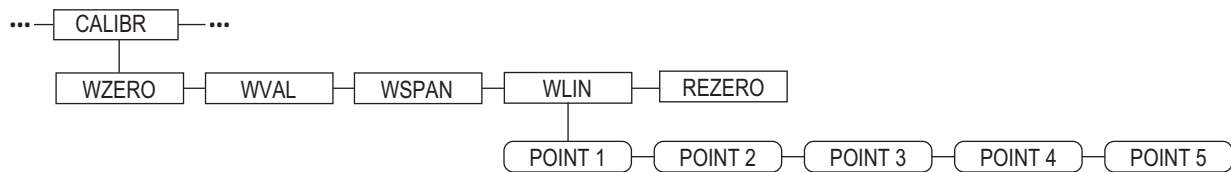

Figure 5-1. Calibration Menu

5.1 Gravity Compensation

Gravity compensation for latitude and elevation is available for the 920i. To calibrate with gravity compensation, the **LOCALE** parameter must be set **ON**. The **LATUDE** (latitude) and **ELEVAT** (elevation, in meters) parameters must also be set prior to calibration (Section 4.8 on page 46).

If the indicator is moved to a different location, gravity compensation can be applied to a pre-calibrated indicator by adjusting the **LATUDE** and **ELEVAT** parameters.

5.2 Front Panel Calibration

The calibration menu, see Section 4.6.4 on page 39, is used to calibrate the 920i. The zero, span, and linear calibration points provide a set of softkeys used specifically for calibration procedures.

+/-

Toggles to allow entry of negative or positive values

Last Zero

Recalls the last established zero value to allow calibration without removing tests weights or product from scale.

Calibrate

Performs calibration for the selected point

Temp Zero

Temporarily zeros the displayed weight of a non-empty scale. After span calibration, the difference between the temp zero and the previously calibrated zero value is used as an offset.

Millivolts (or Counts) Toggles between display of captured A/D counts and captured millivolts values; allows entry of calibration values in mV or counts

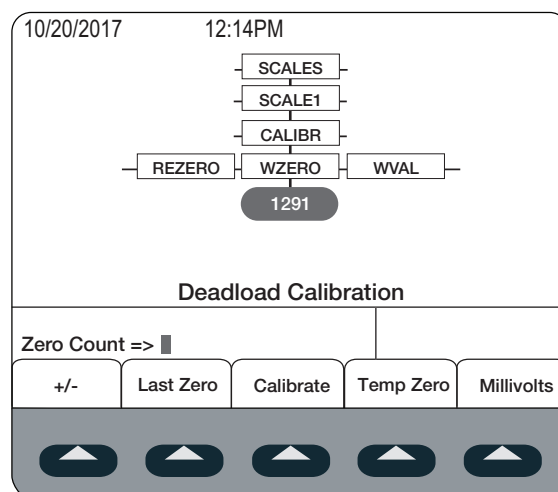













Figure 5-2. WZERO Calibration Display

To calibrate the indicator using the front panel:







1. Place the indicator in setup mode. **Scale Configuration** displays.
2. Remove all weight from the scale platform.
3. If the test weights require hooks or chains, place the hooks or chains on the scale for zero calibration.
4. Highlight the **SCALES** menu and press .
5. Select the scale to be calibrated.
6. Press . **GRADS** displays.
7. Press  to **CALIBR** (Figure 4-8 on page 39).
8. Press  to **WZERO**.
9. Ensure scale is empty and press  to display the current **WZERO** value.
10. Press the **Calibrate** softkey to calibrate zero. When complete, the new A/D count for the zero calibration is displayed.
11. Press  to save the zero calibration value. **WVAL** displays.
12. Press  to display the stored calibration value.
13. Enter the actual value of the calibration test weights using the numeric keypad.
14. Press  to save the value. **WSPAN** displays.
15. Place test weights on scale.
16. Press  to display the current **WSPAN** value.
17. Press the **Calibrate** softkey to calibrate span. The new A/D count for the span calibration is displayed.
18. Press  to save the span calibration value. **WLIN** displays.
19. An optional five-point linearization (**WLIN**) provides increased scale accuracy by calibrating the indicator at up to five additional points between the zero and span calibrations. See [Section 5.2.1 on page 59](#) to include in calibration. If not performing linearization, skip the **WLIN** parameter.
20. An optional re-zero function is used to remove a calibration offset when hooks or chains are used to hang the test weights. See [Section 5.2.2 on page 59](#) to include in calibration.
21. Press  to return to the **SCALES** menu or press the **Save and Exit** softkey to exit setup mode.

5.2.1 Five-Point Linearization (WLIN)

If linearization values have previously been entered, these values are reset to zero during calibration.

- **WZERO** and **WSPAN** must be calibrated before adding linearization points
- **WLIN** values must be less than the **WSPAN** value and must not duplicate **WZERO** or **WSPAN**.





To perform linearization, follow the procedure below:

1. With **WLIN** displayed, press  to go to the first linearization point (**POINT 1**).
2. Press  to show the weight value prompt (**WGT 1**),
3. Press  to show the weight value.
4. Place test weights on the scale.
5. Enter the actual test weight value using the numeric keypad.
6. Press  to save the value and move to the calibration (**CAL 1**) prompt.
7. Press  to show the current calibration value.
8. Press the **Calibrate** softkey to calibrate the linearization point. When complete, the A/D count for the linear calibration is displayed.
9. Press  to save the calibration value and go to the next prompt (**POINT 2**).
10. Repeat for up to five linearization points.
11. Press  to return to WLIN.

5.2.2 Rezero Parameter



NOTE: The rezero function cannot be used with five-point linear calibration.

1. Remove all weight from the scale including test weights, hooks or chains were used during calibration.
2. Press  to return to **CALIBR**.
3. Navigate to the **REZERO**.
4. Press  to show the current zero value.
5. Press the **Calibrate** softkey to adjust the zero and span calibration values.
6. Press  or  to return to **CALIBR** menu.

5.3 Serial Command Calibration

To calibrate the indicator using serial commands, the serial port must be connected to a terminal or personal computer. See [Section 3.3.4 on page 14](#) for serial port pin assignments; see [Section 11.0 on page 103](#) for more information about using serial commands.

Once the indicator is connected to the sending device:

1. Place the indicator in setup mode. **CONFIG** display.
2. Remove all weight from the scale platform. If the test weights require hooks or chains, place the hooks or chains on the scale for zero calibration.
3. Send the SC.WZERO#n serial command (where n is the number of the scale) to calibrate zero.
4. Place test weights on the scale and use the SC.WVAL command to enter the test weight value in the following format:

```
SC.WVAL#n=vvvvv<CR>
```

5. Send the SC.WSPAN#n serial command to calibrate span.
6. Up to five linearization points can be calibrated between the zero and span calibration values. Use the following commands to set and calibrate a single linearization point:

```
SC.WLIN#n.V1=vvvvv<CR>
```

```
SC.WLIN#n.C1<CR>
```

The SC.WLIN#n.V1 command sets the test weight value (vvvvv) for linearization point 1. The SC.WLIN#n.C1 command calibrates the point. Repeat using the SC.WLIN#n.Vx and SC.WLIN#n.Cx commands as required for additional linearization points.

7. To remove an offset value, clear all weight from the scale, including hooks or chains used to hang test weights, then send the SC.REZERO#n serial command.
8. Send the KSAVEEXIT serial command to save the calibration changes and exit setup mode.

5.4 iRev Calibration

The iRev Calibration Wizard provides step-by-step scale calibration. With the 920i connected to the PC, select the Calibration Wizard from the Tools menu. See [Section 6.0 on page 62](#) for a general overview of the iRev utility.

1. In iRev, press Tools and select Calibration Wizard.
2. Select **Standard Calibration** or **Standard with Multi-Point Linearization**.
3. Press to continue.

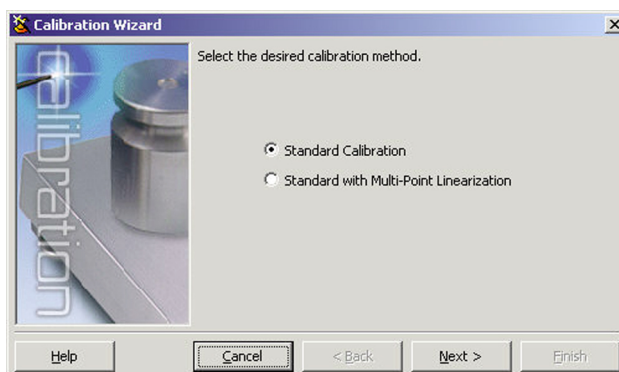

Figure 5-3. iRev 4 Calibration Wizard

4. Select the scale to be calibrated.
5. Enter the test weight used to calibrate the scale. If using chains or hooks to hold the weights, check the box below the test weight value entry. This adds a re-zero step to the calibration sequence.
6. Remove all weights from the scale. If chains or hooks were used, place them on the scale.
7. Press **Calibrate Zero** to perform the zero calibration. A message box displays when the process is complete.
8. Apply the test weights to the scale.
9. Press **Calibrate Span** to perform the span calibration. A message box displays when the process is complete.
10. If the option for chains or hooks was selected in [Step 5](#), the Rezero displays. Remove all weights from the scale, including chains or hooks.
11. Press **ReZero** to calibrate the zero offset.
12. If performing a multi-point linear calibration, up to five other calibration weight values can be entered on the display. The weights must be in ascending order and must not include zero or the span weight. Enter the weight values and press **Go** to calibrate each point.

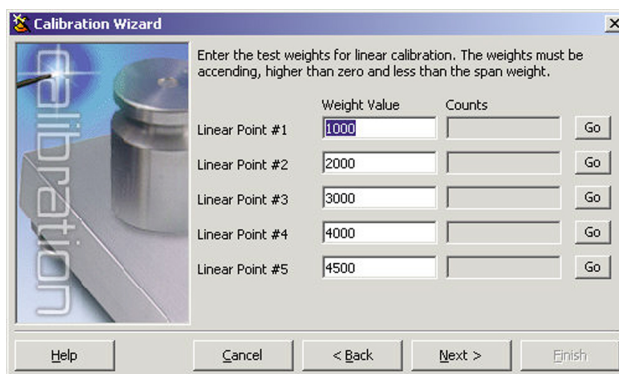

Figure 5-4. iRev 4 Linear Calibration Display

13. Review the new calibration values and press **Finish** to close the Calibration Wizard.



NOTE: To close without saving new values and restore the existing calibration values, press **Cancel**.

6.0 iRev

The iRev utility provides a suite of functions used to support configuration, calibration, customization, and backup of the 920i software. Hardware and software configuration, 920i display setup for up to ten display designs, stream and ticket formatting, setpoint configuration, database management, and iRite program editing are all supported by iRev.

Calibration values, scale, setpoint, display configuration, database tables and user programs can be saved and restored to the 920i using iRev [Section 5.4 on page 61](#).

Other supporting applications provided with iRev include:

- The iRev Editor provides a basic editor and a compiler for writing iRite applications
- The Rice Lake Web Update utility uses an Internet connection to check for and download updates to the iRev and 920i software
- The iLaunch utility can be installed to display a set of icons used for convenient startup of iRev and its supporting applications, including the help system



NOTE: For systems with an iQUBE 1, use iRev 3; All other systems, use iRev 4 and higher.



IMPORTANT: iRev files are not backwards compatible. The iRev version must be newer or the same as the file to be opened.

Recommended System Requirements:

- 1.0+ GHz Intel compatible processor
- 2+ GB of RAM
- 4+ GB hard drive space
- Windows 10

Minimum System Requirements:

- 1.0 GHz Intel compatible processor
- 1 GB of RAM
- 850 MB hard drive space (32 bit)
- 2 GB hard drive space (64 bit)
- Microsoft Windows® 7 SP1 (32 bit, 64 bit)
- A RS-232 port, RS-485 port, USB Port, or Ethernet (TCP/IP) (on indicators with Ethernet support)

6.1 Install iRev Program

iRev is installed using a standard Windows installation procedure. iRev applications and support files are installed in a directory named iRev; icons for the iRev application, the iRev Editor, Uninstall and the Rice Lake Web Update utility are placed in the Windows Start menu.

6.2 Open iRev

1. Install iRev on an IBM-compatible personal computer.
2. With both indicator and PC powered off, connect the PC serial port to the RS-232 pins on the indicator serial port.



NOTE: If there is no serial port on port 2, refer to [Section 7.0 on page 70](#).

3. Power up the PC and the indicator. Use the setup switch to place the indicator in setup mode.
4. Start the iRev program.

iRev provides on-line help for each of its configuration displays. Parameter descriptions provided in this manual for front panel configuration can also be used when configuring the indicator using iRev. The interface is different, but the parameters set are the same.

6.3 Saving and Opening Files

Files are stored with the .920 extension.

Save a File

1. Press the **File** menu and select **Save As...**

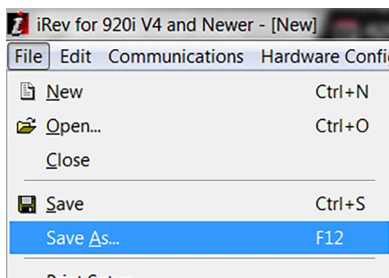

Figure 6-1. File / Save As

2. Navigate to the desired save location.
3. Press **Save**.

Open a Saved File

1. Navigate to the desired file location and double-click the file.
In iRev, press the **File** menu and select **Open....**
2. Navigate to and select the desired file.
3. Press **Open**.

Open a Saved File (iQUBE 1)

1. Launch iRev 3.
2. Press the **File** menu and select **Open....**
3. Navigate to and select the desired file and press open.

6.4 Hardware Configuration

When iRev is started, the Hardware Configuration display is displayed. This display is used to create a virtual hardware configuration for the indicator by dragging and dropping icons for the supported option cards into the empty slots on the display. The slots displayed under Indicator Motherboard, represent the two option card slots on the 920i CPU board and up to twelve slots on attached expansion boards.

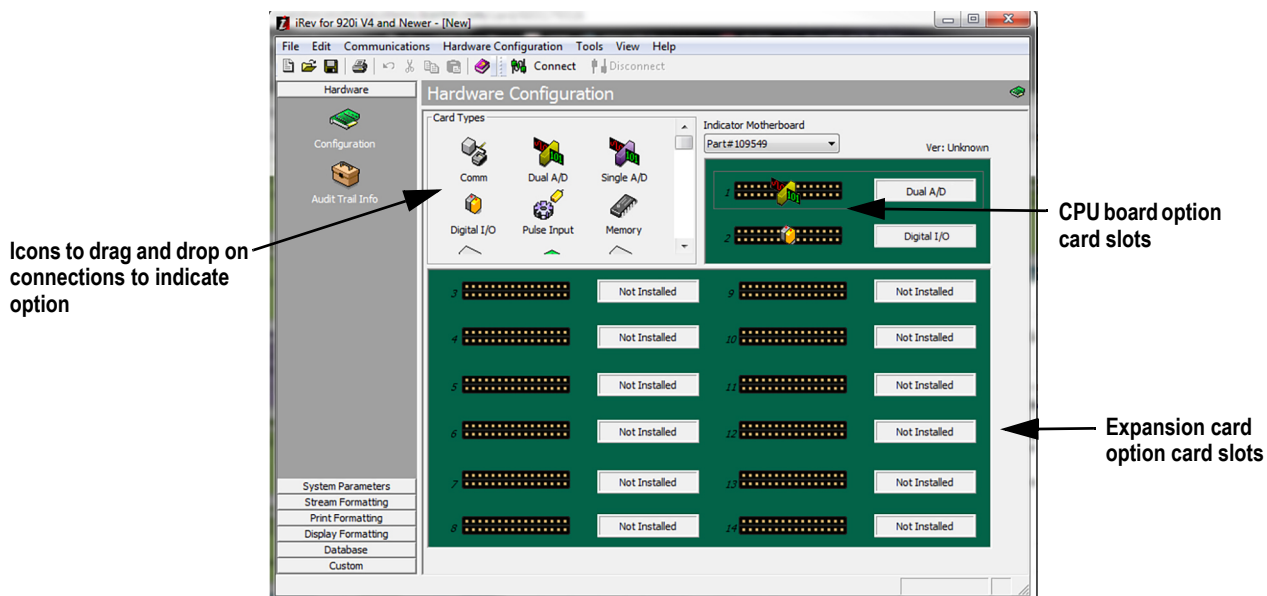

Figure 6-2. iRev 4 Hardware Configuration Display

6.5 Configuring Scales

Scales can be configured by selecting the **System Parameters** listed in the left column under **Hardware**. In most applications, the **Scales** icon, should be configured first. Each scale needs to be associated with an A/D channel or serial scale source.

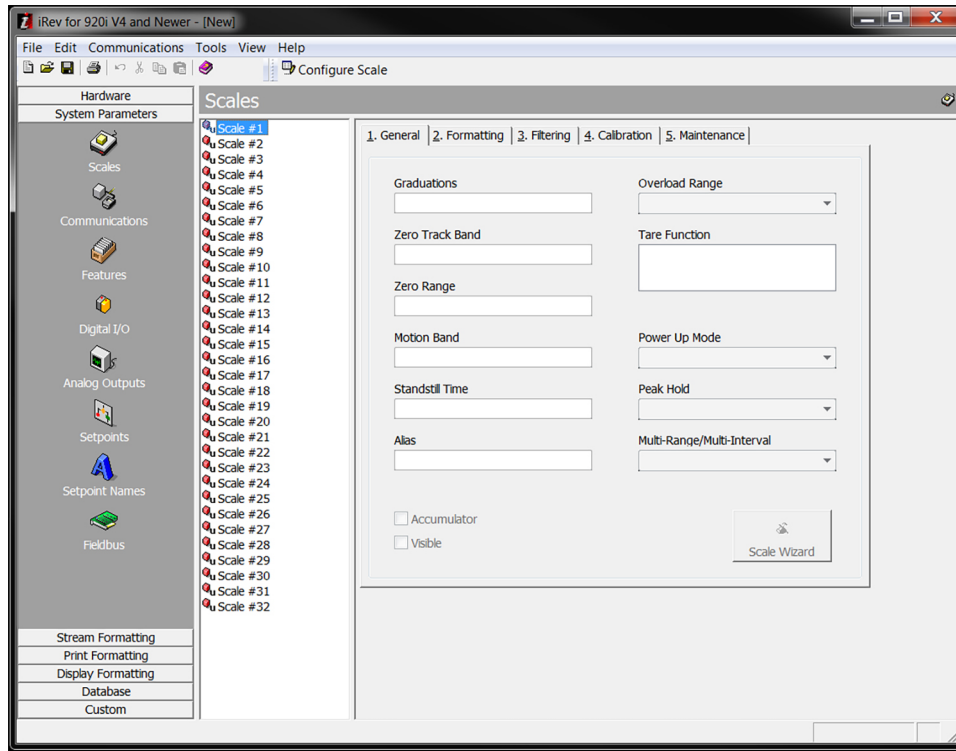



Figure 6-3. iRev 4 Scales Menu

To assign the scale source:

1. Double-click the scale number listed in the Scales menu. The **Config Scale #n** box displays.
2. Select the scale source type by highlighting the circle.
3. Highlight desired source in the **Sources** box.
4. Press  to move the selected type. They can be moved back by reversing this process.

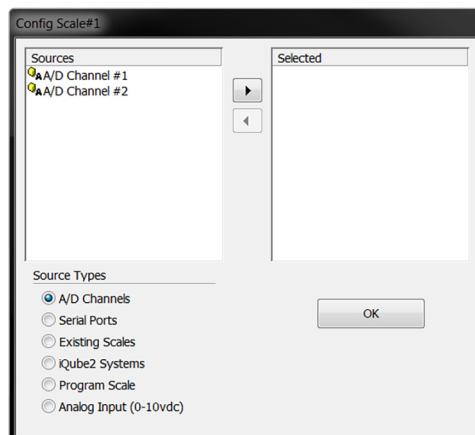



Figure 6-4. Assign Scale Source

5. Press  to save and close box.

6.5.1 Configuring Other Parameters

Once the scale source is set, configure the scale, using the remaining icons listed under **System Parameters**, to create a basic configuration based on the desired application type, units, capacity, and filtering requirements. The Scale Wizard is available to walk through the configuration.

Press  (also available under the Tools menu) to open the Scale Wizard and follow the prompts.

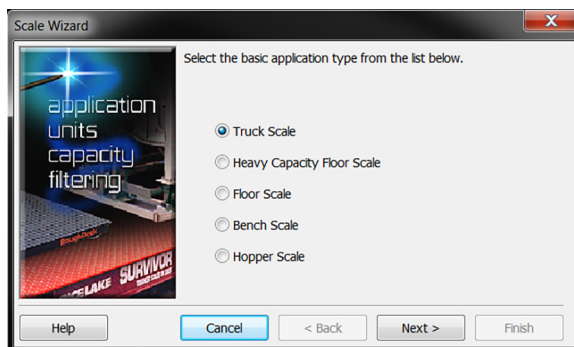

Figure 6-5. Scale Wizard

Other configuration parameters, including stream, print, and display formatting, can be accessed by selecting them from the list displayed at the left side display.

6.5.2 Setpoints

Press the **Setpoints** icon under **System Parameters** to provide access to configuration parameters for up to 100 setpoints.

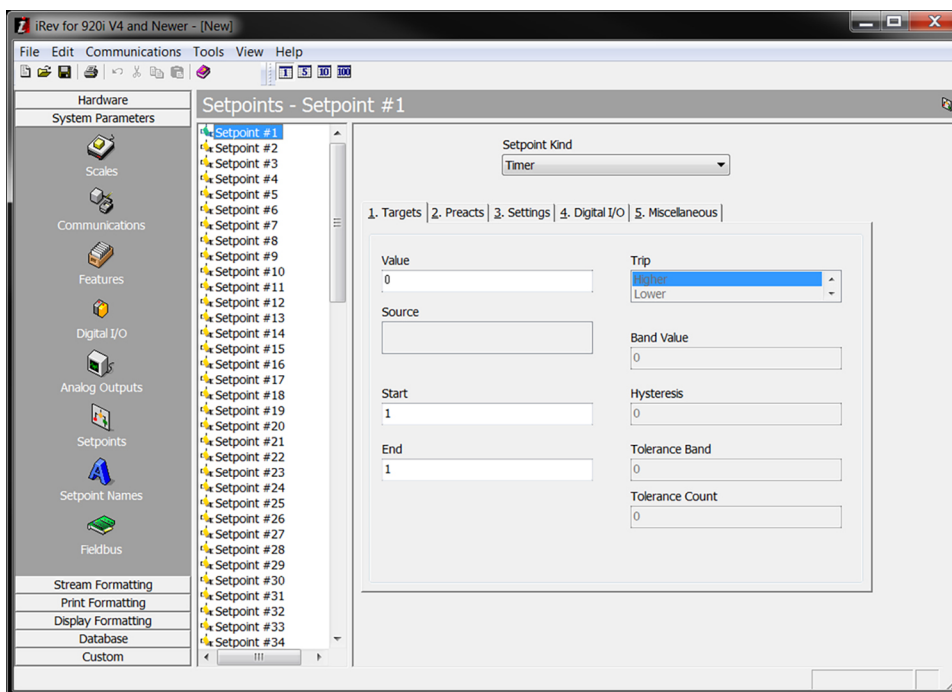

Figure 6-6. Setpoints Display

Setpoint View

- Configured setpoints can be displayed individually or in groups of 5, 10 or 100
- Setpoint parameters can be changed only when shown individually
- Click on the setpoint view icons in the tool bar to change the view

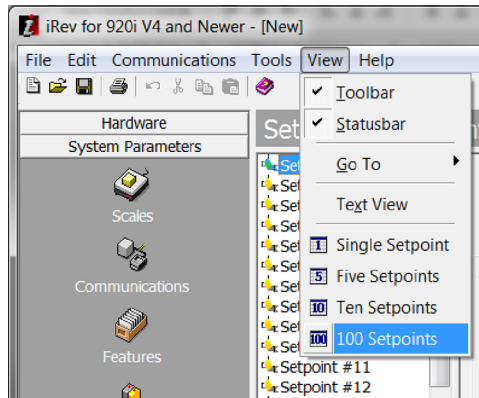

Figure 6-7. Setpoints View

When the setpoint view is set to a value greater than one, swap and move icons are added to the tool bar, allowing single or multiple setpoints to be reordered.

Batching Wizard

The Batching Wizard is used to set up a basic batch sequence, based on the batch type, number of ingredients, and several batch options.

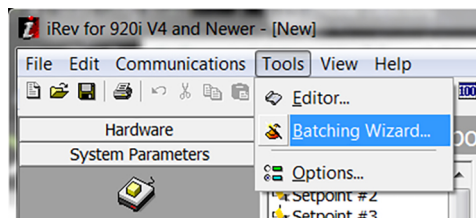

Figure 6-8. Select Batching Wizard

1. Press **Tools** during viewing or changing setpoints.
2. Select **Batching Wizard** to open it, follow the prompts.

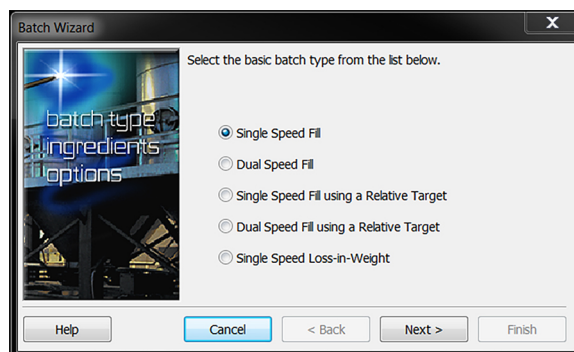

Figure 6-9. Batching Wizard

6.6 Configuring the Display

The iRev display editor allows the 920i display to be customized by dragging and dropping widgets onto a virtual display, then setting parameters specific to each widget type. See [Section 11.2 on page 116](#) for widget programming.

- Up to 10 display configurations can be saved for each indicator file
- Display configurations can be switched within applications using custom programs to drive the 920i

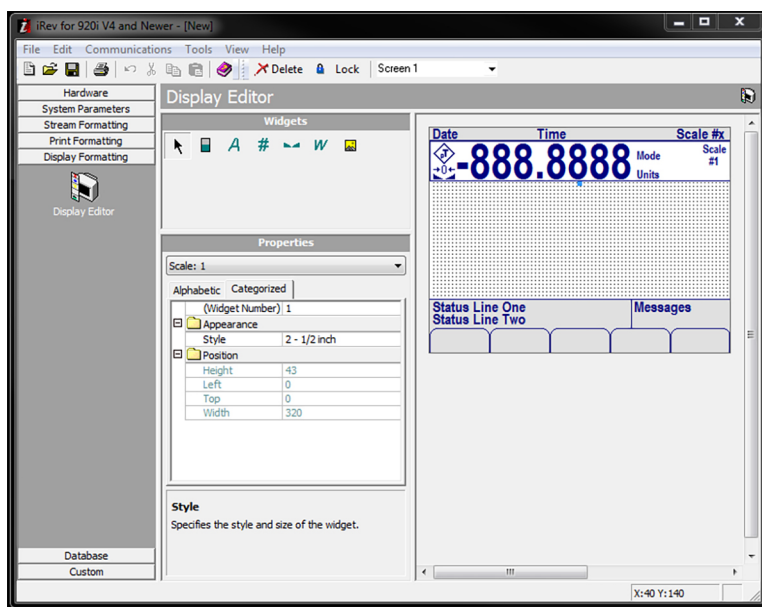

Figure 6-10. Display Editor

6.7 Connecting to the Indicator

This section walks through the connecting of the PC serial port to port 2 of the 920i.

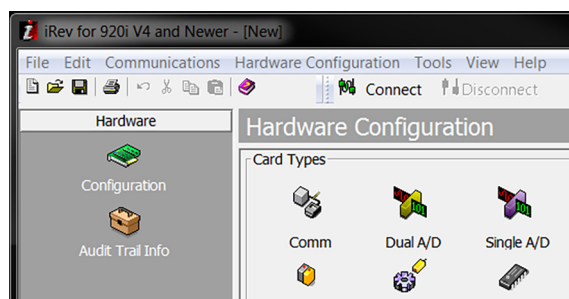

Figure 6-11. Connect to Indicator

1. Select the Hardware Configuration display.
2. Press the **Connect** icon. iRev attempts to establish communications to the indicator.

Once communications is established, iRev queries the indicator configuration to determine whether the indicator hardware matches the virtual hardware configured in the current iRev file.

- If the hardware matches, the Hardware Configuration section of iRev is disabled, preventing further changes
- If the hardware does not match, there is an option of either canceling the connect operation or overwriting the iRev hardware configuration with the actual indicator hardware configuration

6.7.1 Download to Indicator

Downloads are completed using the Communications menu in the top tool bar. There are two options available for download.

- **Download Configuration** – Allows an iRev configuration file (with or without scale calibration data), setpoint data, widgets, database tables or an iRite program file to be downloaded to a connected indicator in setup mode
- **Download Current Display** – Allows the download of the currently displayed object, such as the parameter set for one scale of a multi-scale configuration

Less data is transferred using **Download Current Display**, so it is typically faster than a full configuration download. There is an increased possibility that the download could fail due to dependencies on other objects.

If the download fails, try performing a complete download using the **Download Configuration** function.

A progress message is displayed during the download indicating the progress of the download and also during the clear memory indicating its progress.

6.7.2 Upload Configuration to iRev

Uploads are completed using the Communications menu in the top tool bar.

Upload Configuration – Allows the existing configuration of a connected indicator to be saved to a file on the PC.

- This configuration file provides a backup that can be quickly restored to the indicator if needed
- The file can be edited within iRev 4 then downloaded back to the indicator



NOTE: The indicator must be in setup mode before uploading or downloading data.

6.8 Installing Firmware Upgrades



NOTE: This section applies only to 920i units using a serial board only.

New releases of the 920i system firmware can be downloaded and installed using an Internet connection and the Rice Lake Web Update application.



NOTE: Before upgrading to a new version of 920i system firmware, save a copy of the current indicator configuration using iRev ([Section 6.7.2](#)). Reloading the system firmware requires a **RESETCONFIGURATION** function that resets all configuration and calibration values to factory defaults.

1. Download and install the **ISERIES UPDATE UTILITY** from the www.ricelake.com onto a PC.

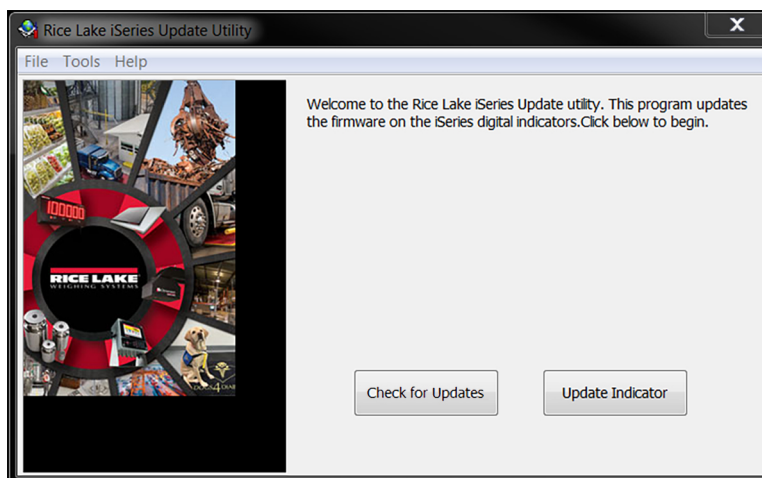

Figure 6-12. Rice Lake iSeries Update Utility

2. Open the iSeries Update Utility and press **Check for Updates** to check for new version of the 920i firmware.
3. Select the new firmware version and press **Get Selection** to download.
4. Disconnect power to the 920i.

5. Connect the PC serial port to port 2 of the 920i. Connection must be made at 38400 bps.

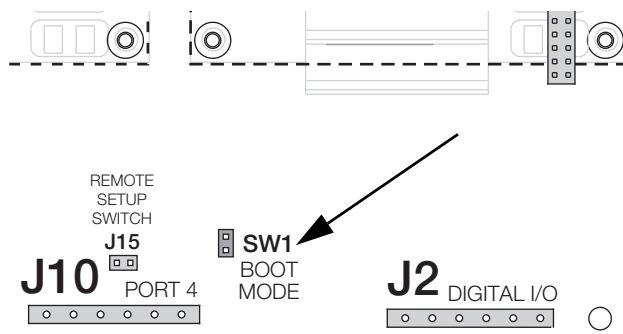

Figure 6-13. SW1 Boot Mode Pins

6. Open the indicator enclosure and place a jumper across the **SW1** boot mode pins.
7. Power up the 920i. The indicator stalls at the diagnostic monitor.
8. Click on the **Update Indicator** button to download the new firmware. When the download begins, the following messages are displayed:

```

Loading...
System Diagnostic Monitor v1.14
$
?
$
?
$KNIX
$SYSLOAD

```

When the download is complete, the indicator display shows the following messages:

```

$DONE
$BOOT
Loading...

```

The indicator resets and goes to weigh mode.

9. Disconnect power to the indicator.
10. Remove the jumper from across the **SW1** boot mode pins and place it on a single pin.
11. Power up the indicator and reload iRev and iRite files as necessary.

7.0 USB Devices

The 920i's USB interface port can be used to connect devices using a type-A or type-B connector.



NOTE: Version 5.00.00 Rev L boards (or higher) are required for USB functionality. See the iRite programming manual for APIs which can perform USB functions. If running a user program, functions may vary.



Figure 7-1. USB Connector Types

Compatible devices using a type-A connector include a flash drive, keyboard, USB hub, and label and ticket printers. The host PC uses a type-B connector.



NOTE: If using a host PC connection, this connection must be terminated prior to switching devices or entering configuration mode on the 920i. Otherwise, Host PC may not display when the USB softkey is pressed once the 920i has returned to weigh mode.

Flash drives allow users to save and load configuration files (.920), save and load database files (.db), load user programs, and update the boot monitor and core firmware. Flash drives must be formatted in the FAT-16 or FAT-32 file system, cannot exceed 4 Gig drive size, cannot exceed eight character name and three character extension. Connecting a USB keyboard allows users to type alphanumeric characters rather than use the front panel buttons.

7.1 USB Driver Installation

Before connecting the 920i to a PC, the appropriate driver must be installed.

1. Open the Rice Lake website at www.ricelake.com.
2. Navigate to the 920i USB page.
3. Click the Downloads tab and expand the **Software** category.
4. Locate the 920i USB Driver Installation entry and click **Download**.

	Version	Size	Download
920i USB Driver Installation		1.4 MB	Download

Figure 7-2. 920i USB Driver Installation

5. Save the file to the computer.
6. Extract the .zip.
7. Open the .exe file. The installer automatically detects the version of Windows and installs the appropriate driver.

7.2 Connecting a USB Device

The 920i will display a list of connected USB devices. Devices in this list can include the following:

- HOSTPC – Used to connect directly to a PC; The PC will automatically assign a virtual comm port; Check PC settings to determine which port is assigned
- PRINTER1 – Used if one printer is connected
- PRINTER2 – Used only if a USB hub is connected, allowing more than one Type-B connection; In this case, the lowest printer ID# will be Printer1
- KEYBOARD – Supports USB keyboards
- DRIVE – Supports USB 2.0 flash drives formatted to the FAT-32 or FAT-16 file system up to 4G maximum

To connect to a USB device:

1. Attach the USB device to the proper USB connector on the indicator; USB connections use Port 2 on the 920i.
2. Press the **USB** softkey.



NOTE: If the USB softkey is not displayed, see [Section 2.6 on page 9](#) and [Figure 4-13 on page 46](#) to enable the softkey.

3. Select the proper device type and press **Enter**.

7.3 Using USB Hubs

Hubs are necessary if multiple USB devices are desired to be simultaneously connected. To achieve best results, use a self-powered hub and follow the below instructions when connecting devices:

1. Connect all USB devices to the hub.
2. With the 920i disconnected from power, connect the hub to the 920i.
3. Connect power to the 920i. All USB devices should be recognized on power-up.

7.4 Disconnecting a USB Device

Prior to unplugging a connected USB device,

1. Press the **USB** softkey.



NOTE: If the USB softkey is not displayed, see [Section 2.6 on page 9](#) and [Figure 4-13 on page 46](#) to enable the softkey.

2. Select **No Device*** and press . This also allows a user program to switch devices via API's.
3. The USB device is now safe to disconnect.

7.5 Loading Configuration Files and Databases

Certain files may take extended periods of time to load directly from a PC to the 920i. For fastest loading times, using a Flash drive is recommended.

It is also recommended to create a folder matching each 920i's unit ID number, if using multiple 920i units. When loading configuration files, the unit will load the file contained in a folder matching its UID# (the default UID# is 1). If no folder matching the UID is found, the unit will load the first file found.

7.5.1 Loading Configuration Files

When a file is loaded from a USB flash Drive, the calibration is always included and will overwrite existing calibration. To eliminate this, the 920i configuration file should be downloaded to the indicator before calibration is completed.



IMPORTANT: If loading a configuration file from a UID subdirectory, ensure the configuration file does not change the unit ID. Otherwise, a .COD file in that subdirectory will not be recognized until the UID is manually reverted to its original number.





NOTE: File names are limited to eight characters.

1. Using a PC, copy the desired configuration file to the flash drive.
2. Connect the flash drive to the 920i's type-A USB connector.
3. Press the **USB** softkey. If the indicator does not have the **USB** softkey and one won't be added, skip to [Step 5](#).



NOTE: If the **USB** softkey is not displayed, see [Section 4.7 on page 39](#) to enable the softkey.

4. Select **Drive** and press .
5. Place the indicator in setup mode and navigate to the **SERIAL » PORT2** menu.
6. Press the **Load File** softkey.
7. Select **Load Configuration (*.920)**.
8. Press .

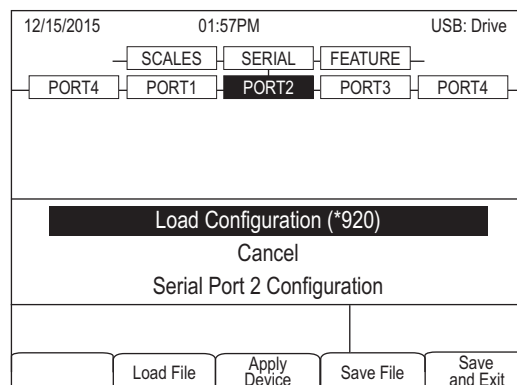

Figure 7-3. Load Configuration Selection *



NOTE: Loading a configuration file will overwrite existing calibration values. If the file to be loaded does not have the correct calibration, record the current values so they can be entered after the download.

7.5.2 Loading Database Files



NOTE: File names are limited to eight characters. If loading a database file, be aware the indicator uses the alias name and a .db file extension when saving database files.

1. Using a PC, copy the desired database file to the flash drive.
2. Connect the flash drive to the 920i Type-A USB connector.
3. Press the **USB** softkey.



NOTE: If the **USB** softkey is not displayed, see [Section 4.7 on page 39](#) to enable the softkey.

Available menu selections will vary depending on USB device type connected ([Table 4-8 on page 39](#)).

4. Select **Drive** and press .

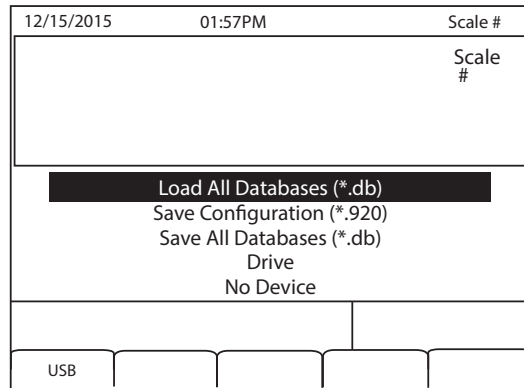

Figure 7-4. Load All Databases selection*

5. Select **Load All Databases (*.db)** and press .

7.6 Saving Configuration Files and Databases

Certain files may take extended periods of time to save directly from a PC to the 920i. For fastest save times, using a Flash drive is recommended.



IMPORTANT: When saving a configuration file, the indicator will attempt to save to a folder matching its UID number (the default UID# is 1). If no such folder is found, the file will be saved to the drives root directory and overwrite any existing files matching its UID# followed by the .920 file extension i.e., 1.920i.



NOTE: When the 920i saves a database, it will use the alias name and a .db file extension.

1. Connect the flash drive to the 920i's type-A USB port.
2. With the indicator in weigh mode, press the **USB** softkey.



NOTE: If the **USB** softkey is not displayed, see [Section 2.5 on page 8](#) and [Figure 4-13 on page 46](#) to enable the softkey.

3. Select **Save Configuration (*.920)** or **Save All Databases (*.db)** and press **Enter**.

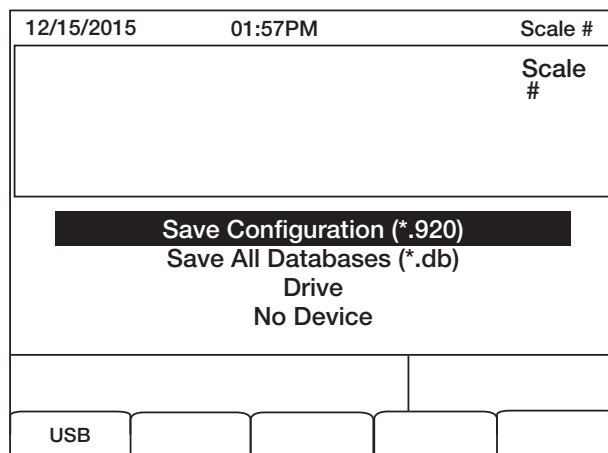

Figure 7-5. Save Configuration menu*

7.7 Loading New Firmware

Prior to loading new firmware, save existing configuration and/or databases by using the instructions in [Section 7.6 on page 73](#).

1. Using a PC, copy the boot monitor (ipl.run) and firmware (920i.run) files to a flash drive.
2. Disconnect power and engage the SW1 jumper.
3. Connect the flash drive to the indicator and reconnect power. The following displays:

```
System Diagnostic Monitor v2.03, 920i
loading...
jumper enabled
checking for connected devices...
USB Interface Board
checking for firmware update...
loading ipl.run boot monitor. Please wait...
*****

finishing load
erasing FLASH boot sectors...
writing to FLASH
```

The unit resets at this point

```
System Diagnostic Monitor v2.03, 920i
loading...
jumper enabled
checking for connected devices...
USB Interface Board
checking for firmware update...
updating boot loader
erasing FLASH boot sectors...
writing to FLASH...
DONE
cycle power to restart boot monitor
```

After power cycle

```
System Diagnostic Monitor v2.03, 920i
loading...
jumper enabled
checking for connected devices...
USB Interface Board
USB Interface V1.01 On-Line:
checking for firmware update...
loading 920iPLUS.run boot monitor. Please wait...
*****

finishing load
erasing FLASH blocks...
writing data to FLASH...
DONE
file load complete
resetting configuration
```

4. Disconnect power, remove the SW1 jumper, and reconnect power

8.0 Print Format

The 920i provides print formats that determine the format of the printed output when the **PRINT** key is pressed, a **KPRINT** serial command is received, or when setpoint push-print or truck weigh-in or weigh-out operations are performed. Supported print formats are: **GFMT**, **NFMT**, **ACCFMT**, **SPFMT**, **TRWIN**, **TRWOUT**, **ALERT**, **AUXFMT1-AUXFMT20**, and **AUDITFMT**. Additionally, two header formats, **HDRFMT1** and **HDRFMT2**, can be inserted into any of the other ticket formats using the **<H1>** and **<H2>** formatting commands. The particular ticket format used for a given print operation depends on the indicator configuration, see [Table 8-10 on page 78](#), and the particular operation performed.

Each print format can be customized to include up to 1000 characters of information, such as company name and address, on printed tickets. Use the iRev 4 configuration utility, serial commands, or the indicator front panel (**PFORMT** menu) to customize the print formats.

8.1 Print Formatting Commands

This section lists commands that can be used to format the 920i print formats. Commands included in the format strings must be enclosed between **<** and **>** delimiters. Any characters outside of the delimiters are printed as text on the ticket.

Text characters can include any ASCII character that can be printed by the output device.

8.1.1 General Weight Data Commands

Supported Ticket Formats – GFMT, NFMT, TRWIN, TRWOUT, ACCFMT, AUXFMTxx, ALERT

Command	Descriptions
<G>	Gross weight, current scale
<G#n>	Gross weight, scale n
<N>	Net weight, current scale
<N#n>	Net weight, scale n
<T>	Tare weight, current scale
<T#n>	Tare weight, scale n
<S>	Current scale number

Table 8-1. General Weight Data Commands

Gross, net, tare, accumulator, truck, and setpoint weights can be printed in any configured weight units by adding the following modifiers to the gross, net, and tare weight commands:

- /P (primary units)
- /D (displayed units)
- /S (secondary units)
- /T (tertiary units)

If not specified, the current displayed units (/D) is assumed.

Example: To format a ticket to show net weight for Scale #3 in secondary units, use the following command: <N#3/S>

Formatted weight strings contain a 10-digit weight field (including sign and decimal point, with leading zeros suppressed), followed by a space and a two-digit units identifier. Total field length with units identifier is 12 (or 13) characters.

If printing data to a ticket printer, the command **<NLnn>** must be put at the end of print format command in order for it print.

8.1.2 Accumulator Commands

Supported Ticket Formats – GFMT, NFMT, ACCFMT, AUXFMTxx

Command	Descriptions
<A>	Accumulated weight, current scale
<A#n>	Accumulated weight, scale n
<AA>	Average accumulation, current scale
<AA#n>	Average accumulation, scale n
<AC>	Number of accumulations, current scale
<AC#n>	Number of accumulations, scale n
<AT>	Time of last accumulation, current scale
<AT#n>	Time of last accumulation, scale n
<AD>	Date of last accumulation, current scale
<AD#n>	Date of last accumulation, scale n

Table 8-2. Accumulator Commands

8.1.3 Truck Mode Commands

Supported Ticket Formats – TRWIN, TRWOUT

Command	Descriptions
<TID>	Truck ID number
<TR1>	Gross weight for current ticket in displayed units
<TR2>	Tare weight for current ticket in displayed units
<TR3>	Net weight for current ticket in displayed units

Table 8-3. Truck Mode Commands

TR1, TR2, and TR3 truck ticket weight data includes keywords INBOUND, KEYED, RECALLED, as necessary.

8.1.4 Setpoint Commands

Supported Ticket Formats – SPFMT

Command	Descriptions
<SCV>	Setpoint captured value
<SN>	Setpoint number
<SNA>	Setpoint name
<SPM>	Setpoint mode (gross or net label)
<SPV>	Setpoint preact value
<STV>	Setpoint target value

Table 8-4. Setpoint Commands

8.1.5 Auditing Commands

Supported Ticket Formats – All

Command	Descriptions
<CD>	Last calibration date
<NOC>	Number of calibrations
<NOW>	Number of weighments since last calibration

Table 8-5. Auditing Commands

Last calibration date (<CD>) and number of calibrations (<NOC>) are updated whenever WZERO, WVAL, WSPAN, or REZERO are changed. Number of weighments (<NOW> command) is incremented whenever the scale weight exceeds 10% of scale capacity. Scale must return to gross or net zero before the value can be incremented again.

8.1.6 Formatting and General-Purpose Commands

Supported Ticket Formats – All

Command	Descriptions
<nnn>	ASCII character (nnn = decimal value of ASCII character); Used for inserting control characters (STX, for example) in the print stream
<TI>	Time
<DA>	Date
<TD>	Time and date
<UID>	Unit ID number (up to 8 alphanumeric characters)
<CN>	Consecutive number (up to 7 digits)
<H1>	Insert header format 1 (HDRFMT1) (Table 8-10 on page 78)
<H2>	Insert header format 2 (HDRFMT2) (Table 8-10 on page 78)
<CR>	Carriage return character
<LF>	Line feed character
<NLnn>	New line (nn = number of termination (<CR/LF> or <CR>) characters); If nn is not specified, 1 is assumed; Value must be in the range 1–99
<SPnn>	Space (nn = number of spaces); If nn is not specified, 1 is assumed; Value must be in the range 1–99
<SU>	Toggle weight data format (formatted/unformatted)

Table 8-6. Formatting and General Purpose Commands

8.1.7 User Program-Dependent Commands

Supported Ticket Formats – All (<USnn>, <AN>) AUXFMTx only (<EVx>)

Command	Descriptions
<USnn>	Insert user print text string (from user program, SetPrintText API)
<EVx>	Invoke user program print handler x (PrintFmtx)
<AN>	Enables the addition of an Alibi Ticket Number

Table 8-7. User Program-Dependent Commands

8.1.8 Alert Format Commands

Supported Ticket Formats – All

Command	Descriptions
<COMP>	Company name (up to 30 characters)
<COAR1> <COAR2> <COAR3>	Contact company address, lines 1–3 (up to 30 characters)
<CONM1> <CONM2> <CONM3>	Contact names (up to 20 characters)
<COPH1> <COPH2> <COPH3>	Contact phone numbers (up to 20 characters)
<COML>	Contact e-mail address (up to 30 characters)
<ERR>	Alert error message (system-generated) ALERT Ticket Format Only

Table 8-8. Alert Format Commands

See the iQUBE² Installation Manual (PN 106113) for more information about using alerts.

8.2 LaserLight Commands

Commands to operate the Stop, Go (circle or arrow) and Off display elements on a LaserLight. These commands are used for front panel softkeys.

Traffic Light State	Aux Fmt	Dry Contact	Serial Command
Stop	AuxFmt1	Dig0 and Dig1 open circuit	00D03!
Green Circle	AuxFmt2	Dig0 open circuit; Dig1 pulled low	00D02!
Green Arrow	AuxFmt2	Dig0 pulled low; Dig1 open circuit	00D01!
Off	AuxFmt3	Dig0 and Dig1 pulled low	00D00!

Table 8-9. LaserLight Commands

8.3 Default Print Formats

Table 8-10 shows the default print formats for the 920i and lists the conditions under which each print format is used. HDRFMT1 and HDRFMT2 specify header information that can be used by other ticket formats. The contents of HDRFMT_x can be inserted by using the <H1> and <H2> formatting commands.

Format	Default Format String	Used When
GFMT	GROSS<G><NL2><TD><NL>	Weigh mode, no tare in system
NFMT	GROSS<G><NL>TARE<SP><T><NL>NET<SP2><N><NL2><TD><NL>	Weigh mode, tare in system
ACCFMT	ACCUM <A><NL><DA> <TI><NL>	Accumulator enabled and displayed or setpoint print operation with PSHACCM=ON
SPFMT	<SCV><SP><SPM><NL>	Setpoint print operation with PSHPRNT=ON
TRWIN	<NL>ID<SP><TID><NL2>GROSS<TR1><NL2><DA><SP><TI><NL>	Press the Weigh In softkey, enter truck ID number then press Enter
TRWOUT	<NL6>ID<SP><TID><NL2>GROSS<TR1><NL>TARE<SP><TR2><NL>NET<SP2><TR3><NL2><DA><SP><TI><NL>	Press the Weigh Out softkey, enter truck ID number then press Enter
TRFMT	REG ID: <TID>: <TR2> SCALE<S> <TD><NL>	Truck register currently displayed
ALERT	<COMP><NL><COAR1><NL><COAR2><NL><COAR3><NL><CONM1> <COPH1><NL><CONM2> <COPH2><NL><CONM3> <COPH3><NL><COML><NL><ERR><NL>	Alert message is sent to specified port when error indication is generated by an attached iQUBE ² ; See the iQUBE ² Installation Manual (PN 106113) for more information
HDRFMT1 HDRFMT2	COMPANY NAME<NL>STREET ADDRESS<NL>CITY, ST ZIP<NL2>	Must be inserted into other print format
AUXFMTxx	GROSS<G><NL2><TD><NL>	Formats AUX1FMT—AUX20FMT
AUDITFMT	Fixed format; cannot be edited	Press Print when audit trail is displayed, or in response to a DUMPAUDIT serial command

NOTE: In OIML and CANADA modes, the letters PT (preset tare) are automatically inserted after the printed tare weight. When using Version 3 of iRev with older indicator software, the single auxiliary format (AUXFMT) is handled as AUXFMT1.

Table 8-10. Default Print Formats

8.4 Customizing Print Formats

The following sections describe procedures for customizing print formats using the iRev 4 configuration utility, serial commands, or the front panel (PFORMAT menu). See [Section 4.7.8 on page 44](#) for information about custom stream formatting.

8.4.1 Using iRev

The iRev 4 configuration utility provides a ticket formatting grid with a tool bar. The grid allows the construction of the ticket format without using the formatting commands (<NL> and <SP>) required by the front panel or serial command methods. Using iRev 4, type text directly into the grid, then select weight value fields from the tool bar and place them where they will appear on the printed ticket.

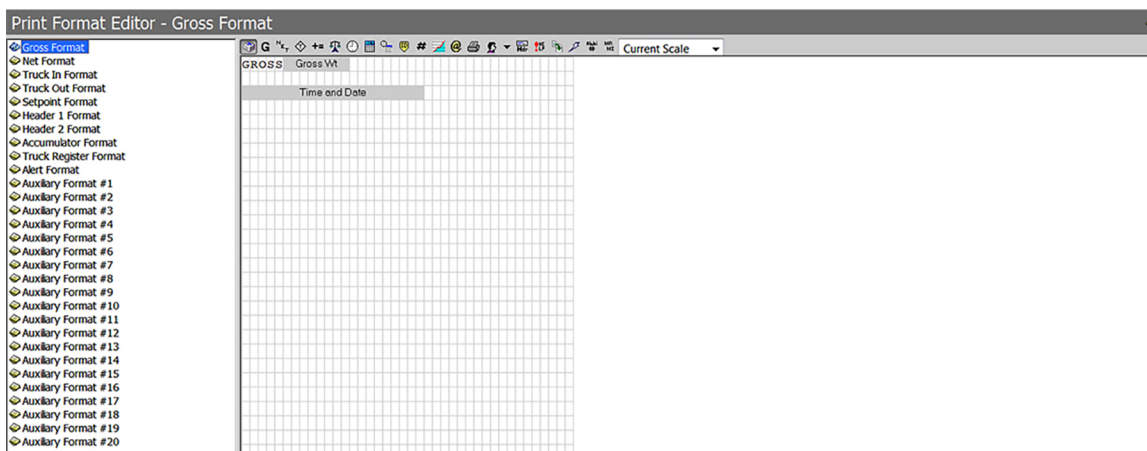

Figure 8-1. iRev Print Format Editor

8.4.2 Using the Front Panel

If there is no access to equipment for communication through a serial port or are working at a site where such equipment cannot be used, use the PFORMAT menu to customize the print formats.

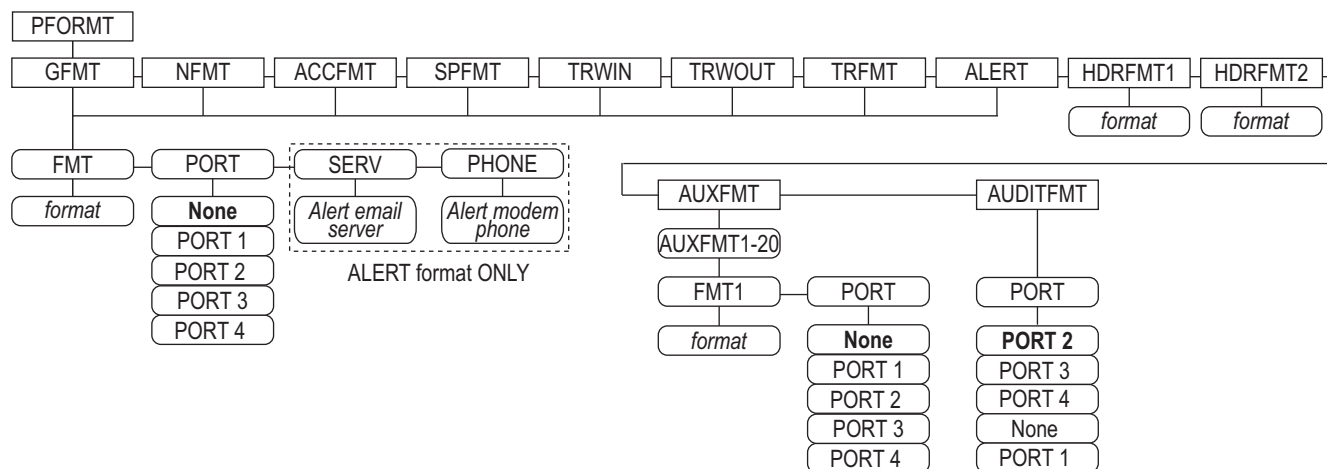

Figure 8-2. Print Format Menu Layout

Each print format can be edited from the front panel using a character selection. Use the navigation keys (**up**, **down**, **left**, **right**) to move around and between the format command line and the character selection list.

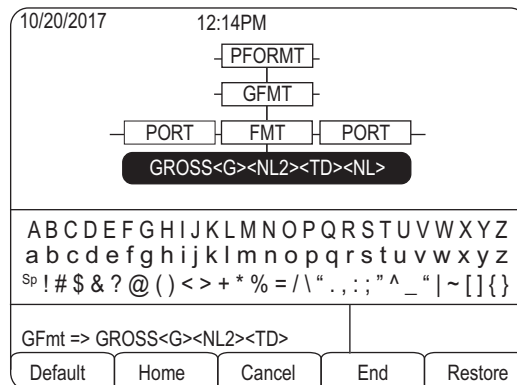

Figure 8-3. Character Selection

To add a character:

1. Position the cursor in the format where the character is to be added.
2. Use the **Up** key to return to the character selection list.
3. Use the navigation keys to highlight the character to add and press **Enter**.

The new character is added to the left of the current cursor location in the format string.

To add a blank space to a string:

1. Position the cursor to the right of where the space is to be inserted in the format string
2. Highlight the **SP** character in the selection list and press **Enter**.

To delete a character:

1. Position the cursor to the right of the character to be deleted from the format string.
2. Press the **Clear** key.

To add a special character:

1. Insert the < and > delimiter characters from the selection list.
2. Use the numeric keypad to insert the decimal ASCII value (1–255) of the character between the delimiters.

Example, insert <2> to add the STX character to the print format.

To save the edited format string:

Position the cursor in the format string and press enter. Softkeys shown on the character selection display provide additional functions:

- Default** – Restores the string to its default value.
- Home** – Positions cursor at the beginning of the format string.
- Cancel** – Exits without saving changes to the format string.
- End** – Positions cursor at the end of the format string.
- Restore** – Restores the string to its previously saved value.

A **Print Test** softkey is shown under the **FMT** parameter after exiting the character selection display. If a printer is attached, this key can be used to verify the edited string format before exiting setup mode.



NOTE: The Print Test softkey is not available for the HDRFMTx formats. These formats can be output only when inserted into one of the printable ticket formats by using the <H1> or <H2> print format commands.

8.4.3 Using Serial Commands

Using a PC, terminal, or remote keyboard attached to one of the 920i serial ports, use the serial command set described in [Section 8.1 on page 75](#) to customize the print format strings.

To view the current setting of a format string, type the name of the print format and press the **Enter** key. For example, to check the current configuration of the GFMT format, type GFMT.FMT and press **Enter**. The indicator responds by sending the current configuration for the gross format:

```
GFMT.FMT=<G> GROSS<NL>
```

To change the format, use the GFMT.FMT or NFMT.FMT serial command followed by an equals sign (=) and the modified print format string. For example, to add the name and address of a company to the gross format, send the following serial command:

```
GFMT.FMT=MOE'S DUMP<NL>2356 EAST HIGHWAY ROAD<NL>SMALLTOWN<NL2><G> GROSS<NL>
```

A ticket printed using this format might look like the following:

```
MOE'S DUMP
2356 EAST HIGHWAY ROAD
SMALLTOWN
1345 LB GROSS
```

The ticket above could also be formatted by specifying the company address information in the HDRFMT1 ticket format, then substituting the <H1> command for the address in the GFMT ticket format:

```
HDRFMT1=MOE'S DUMP<NL>2356 EAST HIGHWAY ROAD<NL>SMALLTOWN<NL2>
GFMT.FMT=<H1><G> GROSS<NL>
```

9.0 Truck Modes

The truck in/out modes are used to handle multiple truck ID numbers and weights. Truck IDs can be up to 16 alphanumeric characters in length.

Six truck modes combine stored ID, keyed tare, and value swapping features in various ways:

Mode	Stored IDs	Keyed Tares	Value Swapping
MODE1	NO	YES	YES
MODE2	NO	NO	YES
MODE3	YES	YES	YES
MODE4	YES	NO	YES
MODE5	YES	YES	NO
MODE6	YES	NO	NO
OFF			

Table 9-1. Truck Mode Features

Stored IDs – Keeps a database of truck IDs and weigh-in weights in the indicator’s memory. The indicator can automatically store up to 1000 truck IDs and tares; or it can clear the information after printing a weigh-out ticket. For example, if the same truck seldom crosses the scale, it may not be practical to save its ID number and weigh-in weight. However, if that same truck crosses the scale many times each day, it’s more convenient to store the information in the indicator memory and recall it when needed. Stored IDs and weights are available in modes 3, 4, 5, and 6.

Keyed tares – Allows manual entering of the tare weight using the numeric keypad and the **Tare** key. Keyed tares are available in modes 1, 3, and 5. To use keyed tares, an incoming truck must be empty at weigh-in, full at weigh-out.



NOTE: Some local regulations require the tare weight to be read from the scale. If so, don’t use the keyed tares feature.

Value swapping – Ensures that the lowest of two weight values associated with a particular ID number is used as the tare weight. For example, if a truck crosses the scale fully loaded at weigh-in, then unloads and crosses the scale empty at weigh-out, the indicator automatically assigns the lesser (empty truck) weight as the tare. Value swapping is available in modes 1, 2, 3 and 4.

9.1 Using the Truck Modes

To select a truck in/out mode:

1. Press the setup switch to enter setup mode.
2. Use the navigation keys to go to the **FEATURE** menu.
3. Navigate to the **TRUCK** sub-menu to select the mode.
4. Press the **Right** key to navigate to the softkeys sub-menu and configure the **Weigh In**, **Weigh Out**, and **Truck Regs** softkeys. These keys are required when using the truck modes.

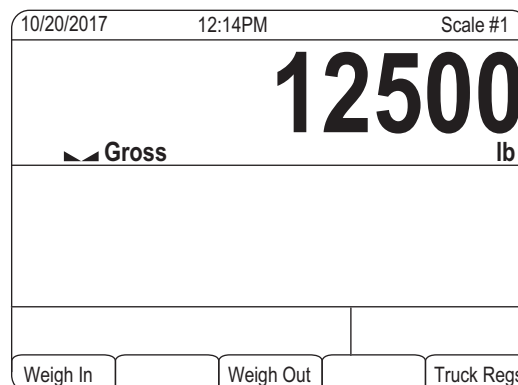

Figure 9-1. Truck Mode Softkeys

9.2 Using the Truck Regs Display

The Truck Regs display is shown by pressing the Truck Regs softkey in weighing mode. The display contains an alphabetical list of stored truck IDs, weigh-in weights (in primary units), and the time and date of the weigh-in transaction.

09/18/2003		03:48PM		Truck IDs	
ACME 152	:	45260 lb	1	03:20PM	09/18/2003
BRF 1454	:	32500 lb	1	03:21PM	09/18/2003
BRF 1468	:	32500 lb	1	03:21PM	09/18/2003
GREEN 12	:	45260 lb	1	03:22PM	09/18/2003
GREEN 66	:	44220 lb	1	03:23PM	09/18/2003
HILL 11	:	43140 lb	1	03:24PM	09/18/2003
HILL 52	:	34760 lb	1	03:25PM	09/18/2003

Page Up	Page Down	Cancel	Delete	Delete All
---------	-----------	--------	--------	------------

Figure 9-2. Truck Register Display

Softkeys shown at the bottom of the Truck Regs display are described below.

- Page Up** – Displays previous page of the truck register.
- Page Down** – Displays next page of the truck register.
- Cancel** – Exits to weighing mode.
- Delete** – Deletes the highlighted truck ID from the truck register.
- Delete All** – Deletes all truck IDs from the truck register.

The truck register can be printed to an attached printer by pressing the **Print** key while the Truck Regs display is shown. The printed register uses the **TRFMT** print format (Section 8.3 on page 78).



NOTE: If a non-zero setpoint password is configured (SPPWD parameter on the FEATURE menu), password must entered before any truck register entries can be deleted.

9.3 Weigh-In Procedure

In modes 1 and 2, the indicator erases truck ID numbers and tare weights from memory after the transaction. In modes 3–6, the truck ID and weigh-in weight values are saved after the weigh-out ticket has been processed.

The general weigh-in procedure is as follows:

1. The empty truck moves onto the scale for weigh-in.
2. Press the **Weigh In** softkey.
3. A prompt is shown to enter the truck ID (up to eight alphanumeric characters). Enter the ID, then press the **Enter** key.
4. Indicator generates the weigh-in ticket:

```
ID 304812
      GROSS 15000. LB INBOUND
      01/14/2002 10:24 AM
```
5. Truck leaves the scale.

9.4 Weigh-Out Procedure

The general weigh-out procedure is as follows:

1. The loaded truck moves onto the scale for weigh-out.
2. If truck ID is known, press the **Weigh Out** softkey, enter the ID, and press the **Enter** key.
If ID is not known, press the **Truck Regs** softkey to view list of stored IDs (Figure 9-2 on page 83). Scroll to the correct truck ID, note the ID number, then press the **Cancel** softkey to return to the weight display. From the weight display, press **Weigh Out**, key in the ID, then press the **Enter** key.
3. Indicator generates the weigh-out ticket. In modes 1 and 2, the ID is deleted once the weigh-out ticket is processed.

9.5 Single-Transaction Tare Weights and IDs

One-time transactions are supported in all modes that can be configured to use stored IDs (modes 3–6). This function allows one-time weighing of trucks without adding the truck ID and weigh-in weight to the permanent truck register.

To use this function, press the **Weigh In** or **Weigh Out** softkey, then enter a truck ID containing a decimal point. IDs entered with a decimal point as part of the ID are erased from the truck register when the transaction is complete.

10.0 Setpoints

The 920i indicator provides 100 configurable setpoints for control of both indicator and external equipment functions. Setpoints can be configured to perform actions or functions based on specified parameter conditions. Parameters associated with various setpoint kinds can, for example, be configured to perform functions (print, tare, accumulate), to change the state of a digital output controlling indicator or external equipment functions, or to make conditional decisions.



NOTE: *Weight-based setpoints are tripped by values specified in primary units only.*

10.1 Batch and Continuous Setpoints

920i setpoints can be either continuous or batch setpoints.

Continuous Setpoints – Free-running: the indicator constantly monitors the condition of free-running setpoints at each A/D update. The specified setpoint action or function is performed when the designated setpoint parameter conditions are met. A digital output or function assigned to a free-running setpoint continuously changes state, becoming active or inactive, as defined by the setpoint parameters.

Batch Setpoints – Active one at a time, in an ordered sequence. The 920i can use setpoints to control up to 100 separate batch processing steps.

A digital output associated with a batch setpoint is active until the setpoint condition is met, then latched for the remainder of the batch sequence.

To use batch setpoints, activate the **BATCHNG** parameter on the **SETPTS** menu. This parameter defines whether a batch sequence is automatic or manual. **AUTO** sequences repeat continuously, **MANUAL** sequences require a **BATSTRT** signal. The **BATSTRT** signal can be initiated by a digital input, serial command, **Batch Start** softkey, or the **StartBatch** function in an iRite program.

For setpoint kinds that can be used as either continuous or batch setpoints, the **BATCH** parameter must also be set ON. (Setpoint kinds that can only be used as batch setpoints do not require the **BATCH** parameter.) If the setpoint is defined but the **BATCH** parameter is off, the setpoint operates as a continuous setpoint, even during batch sequences.



NOTE: *In applications that contain both batch setpoint routines and continuous setpoints, continuous setpoints should be kept separate from the batch sequence. This is especially true when using **CONCUR** or **TIMER** setpoints to perform actions or functions based on the batch sequence. **CONCUR** and **TIMER** setpoints should not be included in the referenced **START** and **END** setpoint sequence.*

Kind	Descriptions	Batch	Continuous
OFF	Setpoint turned off/ignored	--	--
GROSS	Performs functions based on gross weight; Target weight entered is considered a positive gross weight	X	X
NET	Performs functions based on net weight; Target weight entered is considered a positive net weight value	X	X
-GROSS	Performs functions based on gross weight; Target weight entered is considered a negative gross	X	X
-NET	Performs functions based on net weight; Target weight entered is considered a negative net weight	X	X
ACCUM	Accumulator – Compares value of setpoint to source scale accumulator; Accumulator setpoint is satisfied when value of source scale accumulator meets the value and conditions of the accumulator setpoint	X	X
ROC	Rate of Change – Performs functions based on the rate-of-change (ROC) value	X	X
+REL	Positive Relative – Performs functions based on a specified value above a referenced setpoint, using the same weight mode as the referenced setpoint	X	X
-REL	Negative Relative Setpoint – Performs functions based on a specified value below a referenced setpoint, using the same weight mode as the referenced setpoint	X	X
%REL	Percent Relative Setpoint – Performs functions based on a specified percentage of the target value of a referenced setpoint, using the same weight mode as the referenced setpoint; The actual target value of the %REL setpoint is calculated as a percentage of the target value of the referenced setpoint	X	X
RESREL	Result Relative – Relative to a result setpoint; performs functions based on specified percentage of captured value of a referenced setpoint, using same weight mode as referenced setpoint; Target value of RESREL setpoint is calculated as a percentage of captured value of the referenced setpoint, rather than the target value	X	X
PAUSE	Pauses the batch sequence indefinitely; BATSTRT signal must be initiated to continue the batch process	X	--
DELAY	Delays batch sequence for a specified time; Length of delay (in 0.1 seconds) is specified in VALUE parameter	X	--
WAITSS	Wait for Standstill – Suspends the batch sequence until the scale is at standstill	X	--

Table 10-1. Setpoint Kinds

Kind	Descriptions	Batch	Continuous
COUNTER	Specifies number of consecutive batch sequences to perform; Counter setpoints should be placed at beginning of a batch routine	X	--
AUTOJOG	Automatically checks the previous weight-based setpoint to verify the setpoint weight value is satisfied in a standstill condition; If previous setpoint was not satisfied when at standstill, the AUTOJOG setpoint activates the digital output of previous weight-based setpoint for a period of time, specified on the VALUE parameter; Auto-jog process repeats until previous weight-based setpoint is satisfied when the scale is at standstill NOTE: An AUTOJOG digital output is used to signify an auto-jog operation is being performed. AUTOJOG should not be assigned to the same digital output as the related weight-based setpoint.	X	--
COZ	Center of Zero – Monitors for a gross zero condition; Digital output associated with this setpoint kind is activated when the referenced scale is a center of zero; No value is required for this setpoint	--	X
INMOTON	Monitors for an in-motion condition; Digital output associated with this setpoint is activated when the scale is not at standstill; No value is required for this setpoint	--	X
INRANGE	Monitors for an in-range condition; Digital output associated with this setpoint is activated when the scale is within capacity range; No value is required for this setpoint	--	X
BATCHPR	Batch Processing Signal – Digital output associated with this setpoint is activated whenever a batch sequence is in progress; No value is required for this setpoint	--	X
TIMER	Tracks the progress of a batch sequence based on a timer; Timer value (in 0.1 seconds) on the VALUE parameter, determines the length of time allowed between start and end setpoints; Indicator START and END parameters are used to specify the start and end setpoints; If the END setpoint is not reached before the timer expires, the digital output associated with this setpoint is activated	--	X
CONCUR	Allows a digital output to remain active over a specified portion of the batch sequence; Two types of concur setpoints can be configured: Type 1 (VALUE=0): the digital output associated with this setpoint becomes active when the START setpoint becomes the current batch step and remains active until the END setpoint becomes the current batch step Type 2 (VALUE > 0): if a non-zero value is specified for the VALUE parameter, that value represents the timer, (in 0.1 second) for this setpoint; the digital output associated with this setpoint becomes active when the START setpoint becomes the current batch step and remains active until the timer expires NOTE: The digital output assigned to the Concur Setpoint should not be used by another Concur setpoint; this may cause a conflict in setting the output state.	--	X
DIGIN	Digital Input – Requires a specific group of digital inputs to be in low (0 VDC) state to satisfy the setpoint; Digital output associated with this setpoint is held in low (0 VDC) state until inputs selected for digital input mask are all in a low state	X	X
AVG	Average – Performs functions based on calculated average weight over a specified number of A/D samples NOTE: This setpoint is based on the raw A/D weight value, rather than the rounded value shown on the display. Example: if 50.0 displays, but the actual raw A/D value is 49.99, the setpoint is not be satisfied.	X	--
TOD	Time of Day – Performs functions when the internal clock time of the indicator matches the specified setpoint time	X	X
DELTA	Delta Weight – Satisfied when change in weight on the scale is equal to or exceeds the absolute value specified for the setpoint	X	--
CHKWEI	Checkweigher – Allows specification of over- and under-weight value; Up to three digital outputs can be configured to represent overweight, underweight, and accept conditions	--	X
PLSCNT	Pulse Counter – Performs functions based on pulse counts received by a pulse input card	X	X
PLSRAT	Pulse Rate – Performs functions based on the pulse rate received by a pulse input card	--	X
ALWAYS	Always – Setpoint always satisfied; Typically used to provide an endpoint for true/false branching batch routines	X	--
NEVER	Never – Setpoint is never satisfied; It is used to branch to a designated setpoint in true/false branching batch routines in which batch will not continue through the normal sequence of batch setpoints	X	--
DINCNT	Digital Input Count – Counts pulses received at the specified digital input	X	X

Table 10-1. Setpoint Kinds (Continued)

10.2 Setpoint Menu Parameters

Figure 10-1 shows the general structure of the setpoint menu. Group menus for setpoint kinds are shown on the following pages; parameter descriptions for the menus are provided in Table 10-3 on page 96.

See Table 10-1 on page 85 for descriptions of each of the setpoint kinds.

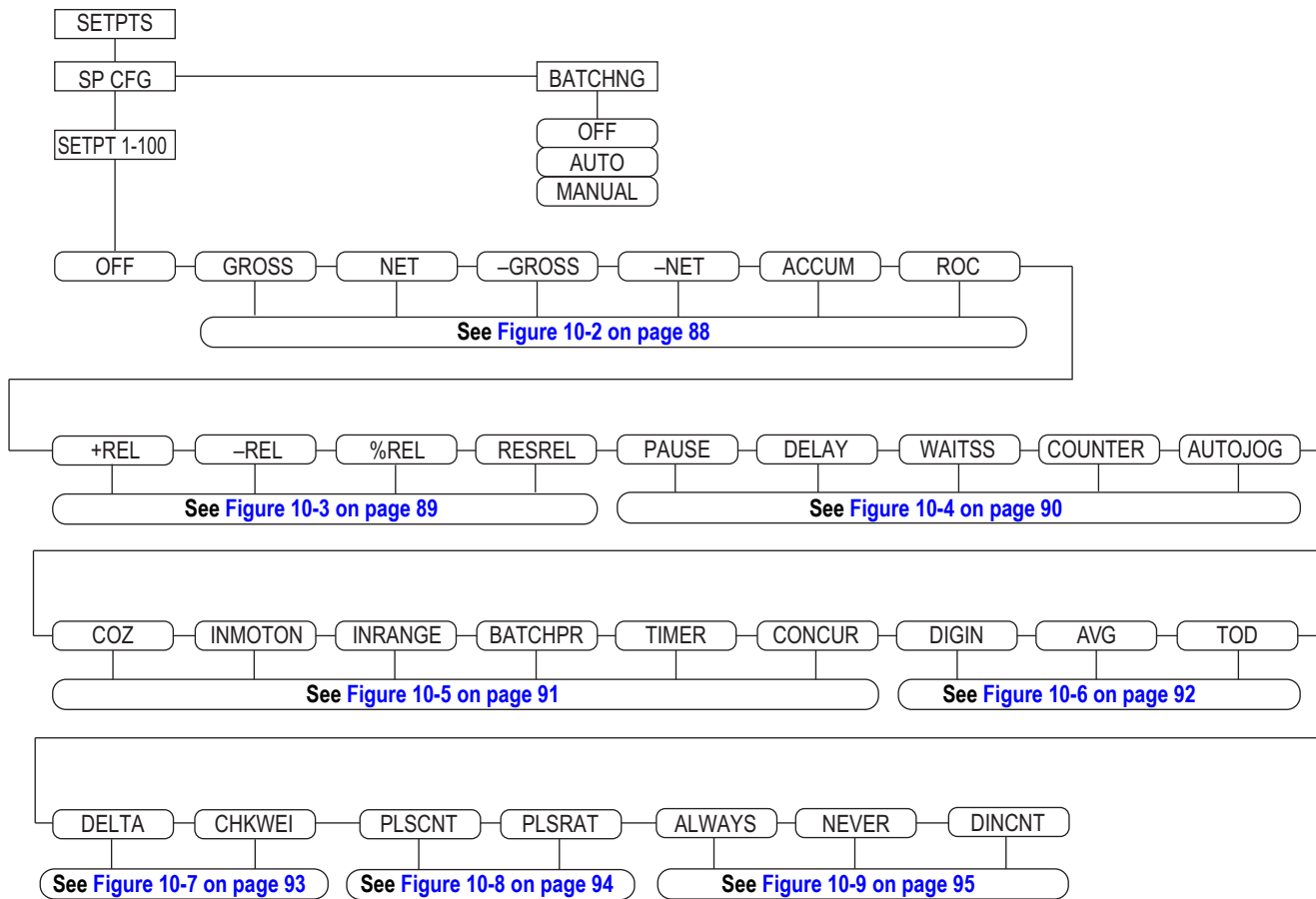

Figure 10-1. Setpoint Menu

Parameter	Descriptions
SETPT 1– SETPT 100	Setpoint Kind; Settings: OFF (default), GROSS, NET, –GROSS, –NET, ACCUM, ROC, +REL, –REL, %REL, RESREL, PAUSE, DELAY, WAITSS, COUNTER, AUTOJOG, COZ, INMOTON, INRANGE, BATCHPR, TIMER, CONCUR, DGIN, AVG, TOD, DELTA, CHKWEI, PLSCNT, PLSRAT, ALWAYS, NEVER, DINCNT Batch or Continuous Setpoints: GROSS, NET, –GROSS, –NET, ACCUM, ROC, +REL, –REL, %REL, RESREL. DIGIN, DINCNT, AVG, TOD Batch Sequences Only: PAUSE, DELAY, WAITSS, COUNTER, AUTOJOG, DELTA, PLSCNT, ALWAYS, NEVER Continuous Setpoints Only: COZ, INMOTON, INRANGE, BATCHPR, TIMER, CONCUR, PLSRAT, CHKWEI See Table 10-1 on page 85 for more information about setpoint kinds
BATCHNG	Batching Enable – OFF (default), AUTO or MANUAL: allows batch sequence to run <ul style="list-style-type: none"> MANUAL: requires BATSTRT digital input, BATSTART serial command, Batch Start softkey, or StartBatch function in an iRite program before the batch sequence can run AUTO: allows batch sequences to repeat continuously

Table 10-2. Setpoint and Batching Menu

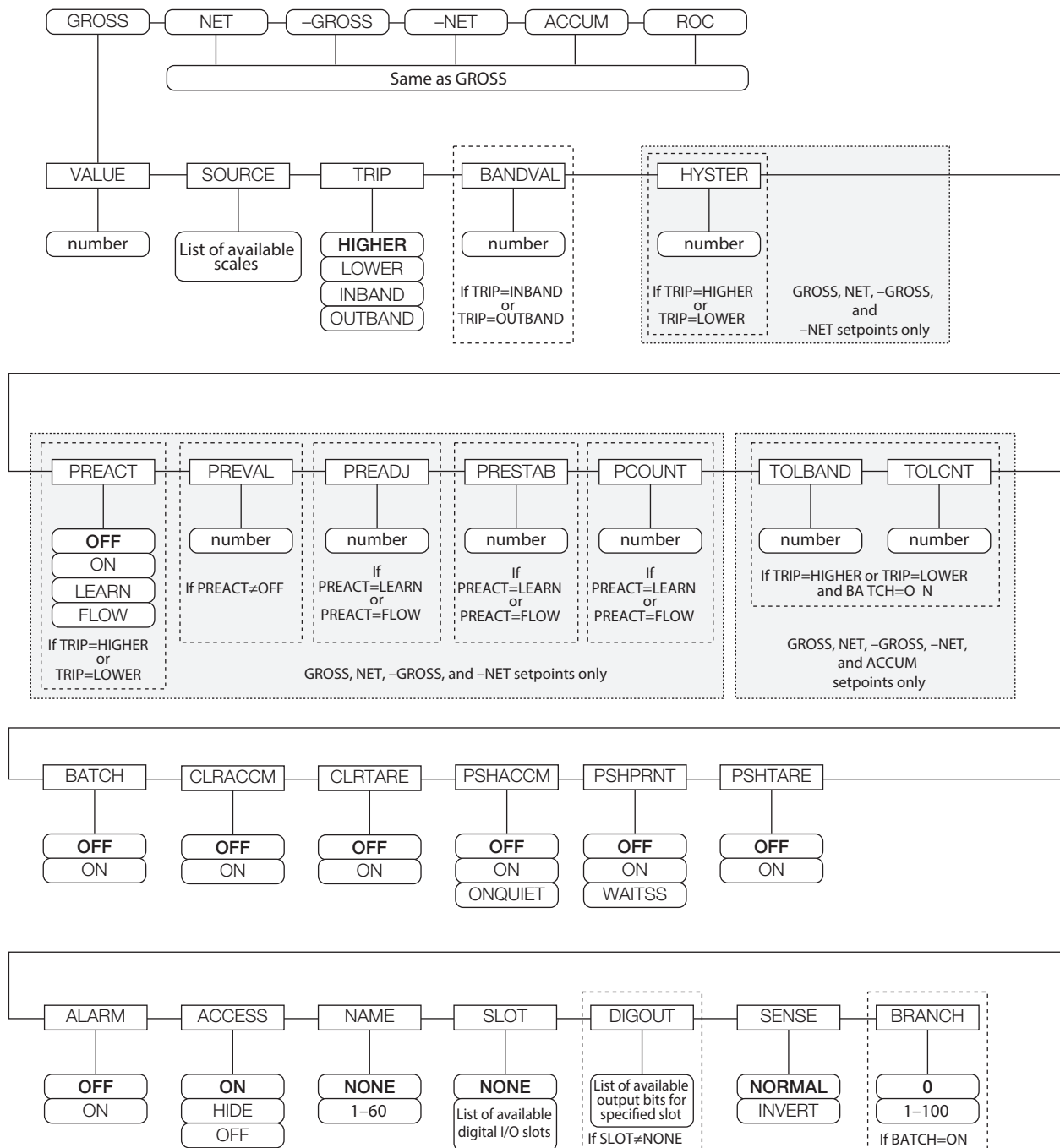

Figure 10-2. GROSS, NET, -GROSS, -NET, ACCUM, and ROC Setpoint Parameters

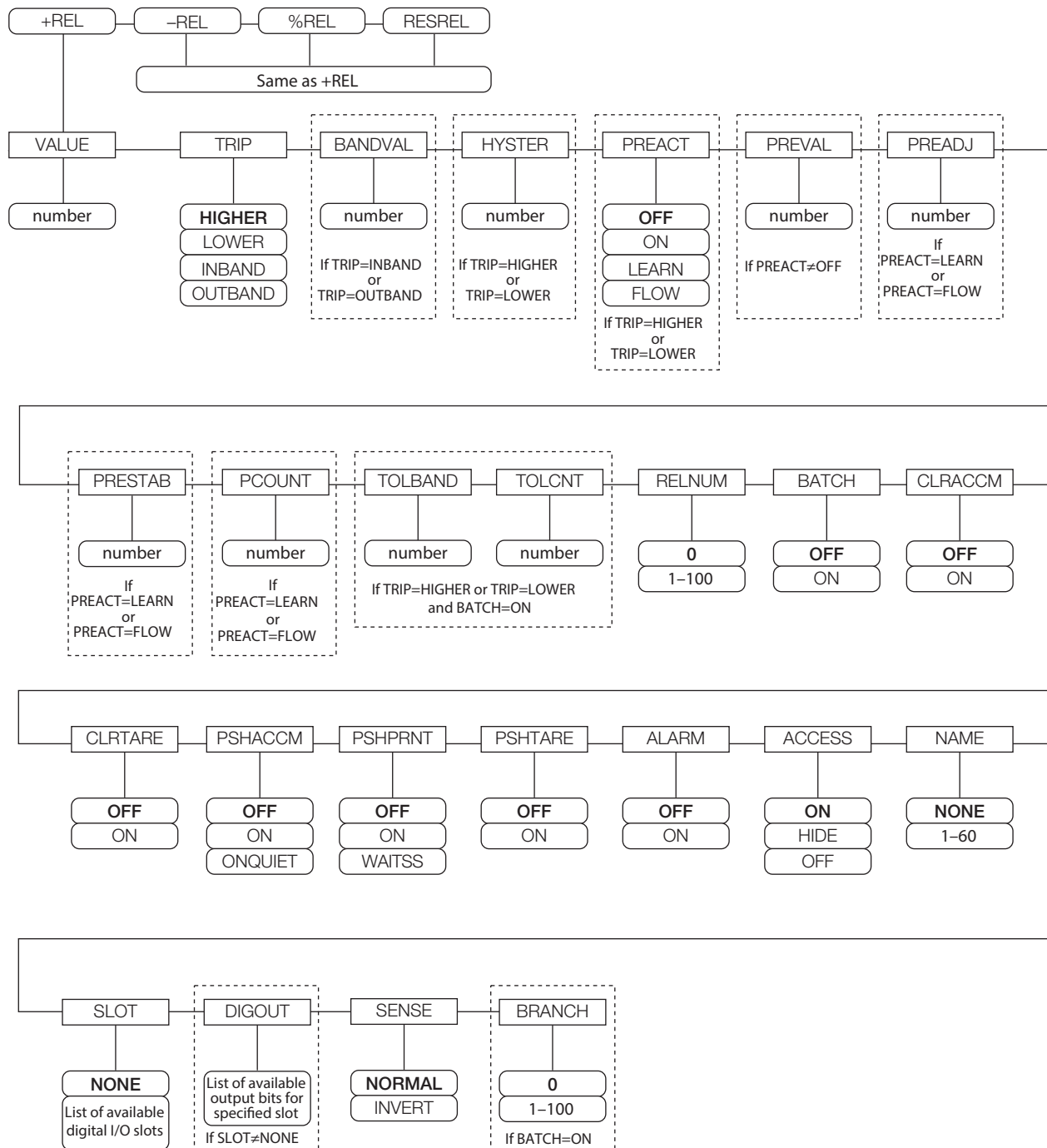

Figure 10-3. +REL, -REL, %RELS and RESREL Setpoint Parameters

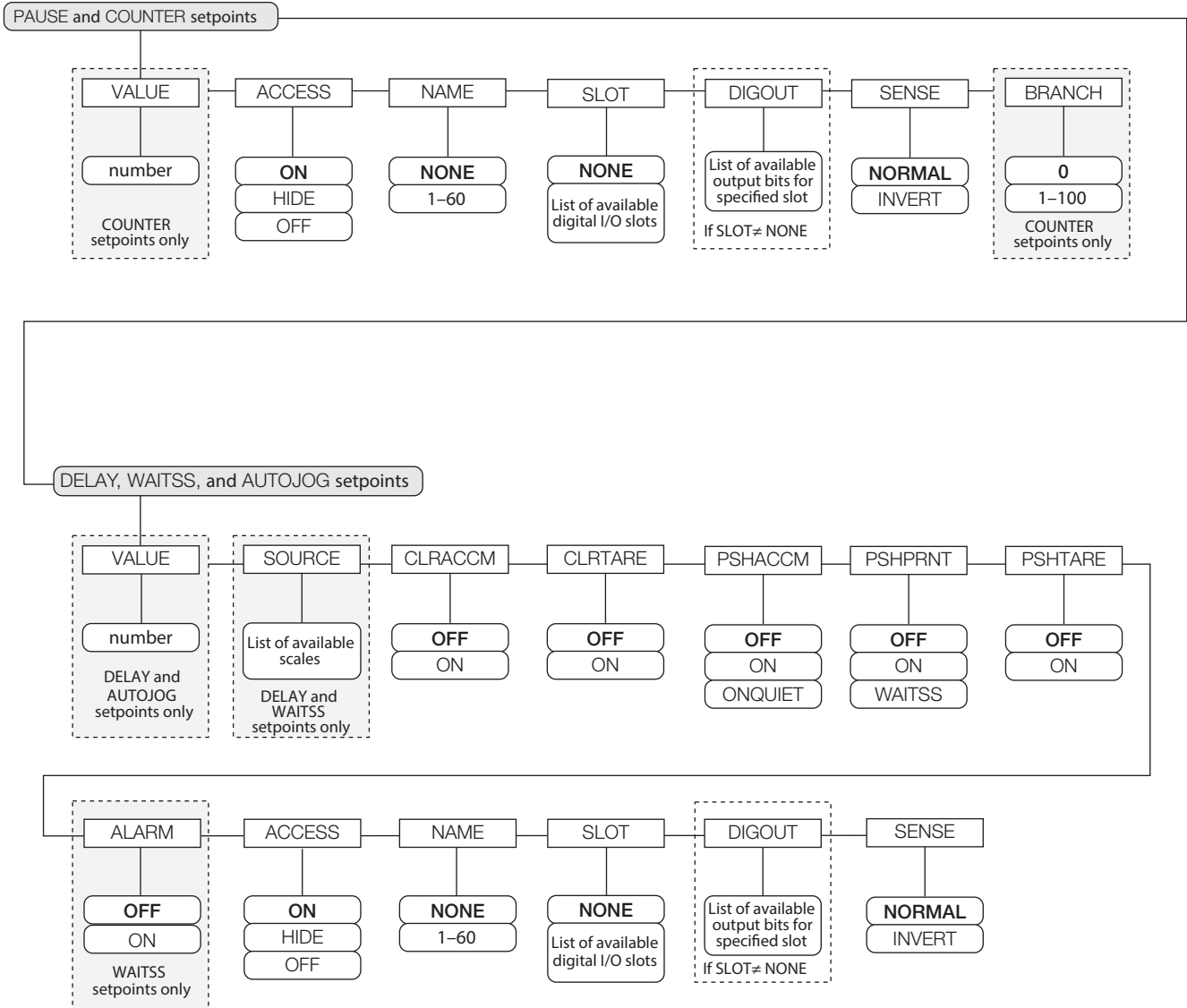

Figure 10-4. PAUSE, COUNTER, DELAY, WAITSS, and AUTOJOG Setpoint Parameters

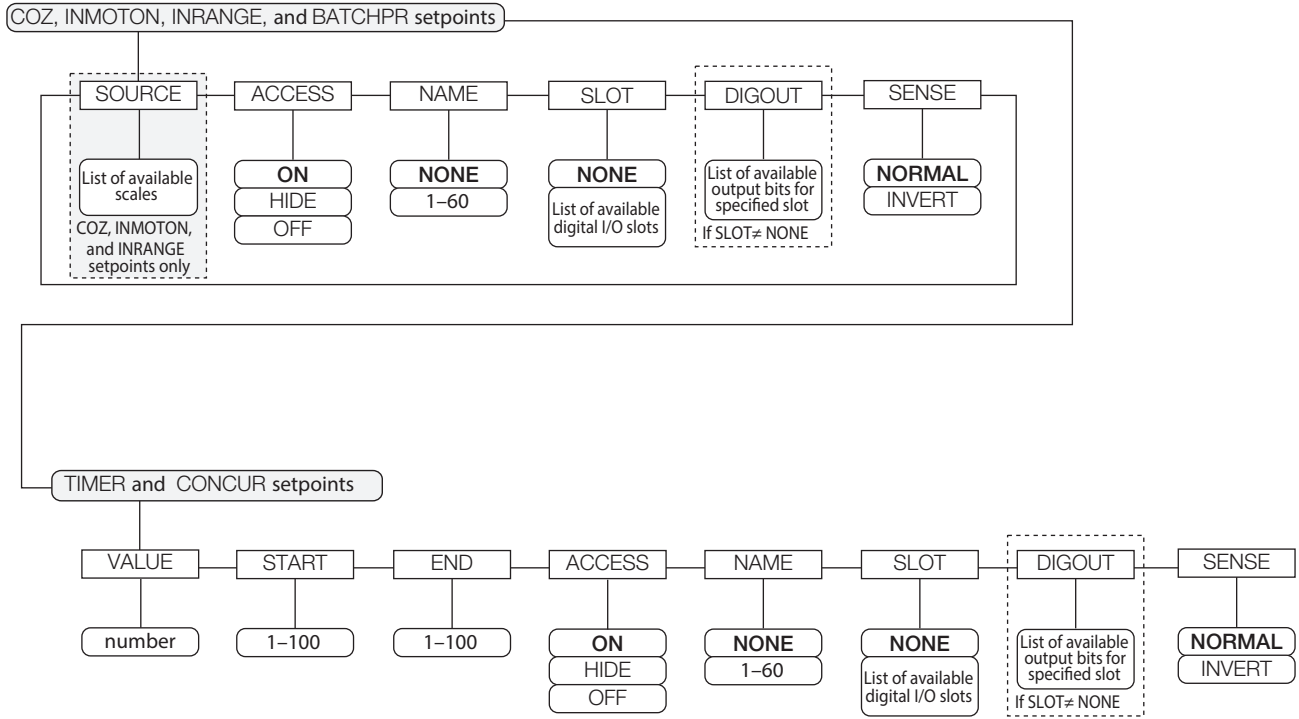

Figure 10-5. COZ, INMOTON, INRANGE, and BATCHPR Setpoint Parameters

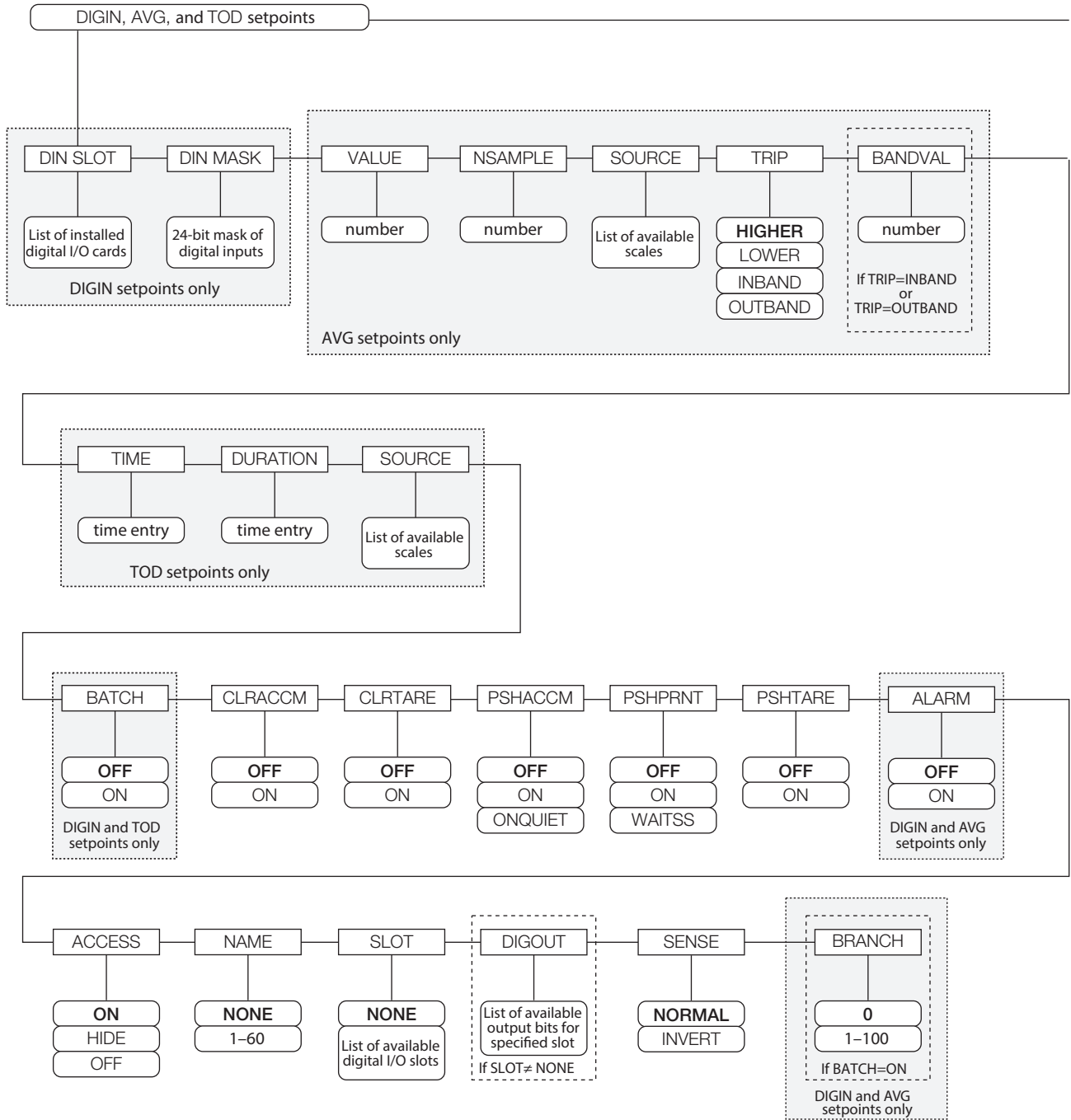

Figure 10-6. DIGIN, AVG, and TOD Setpoint Parameters

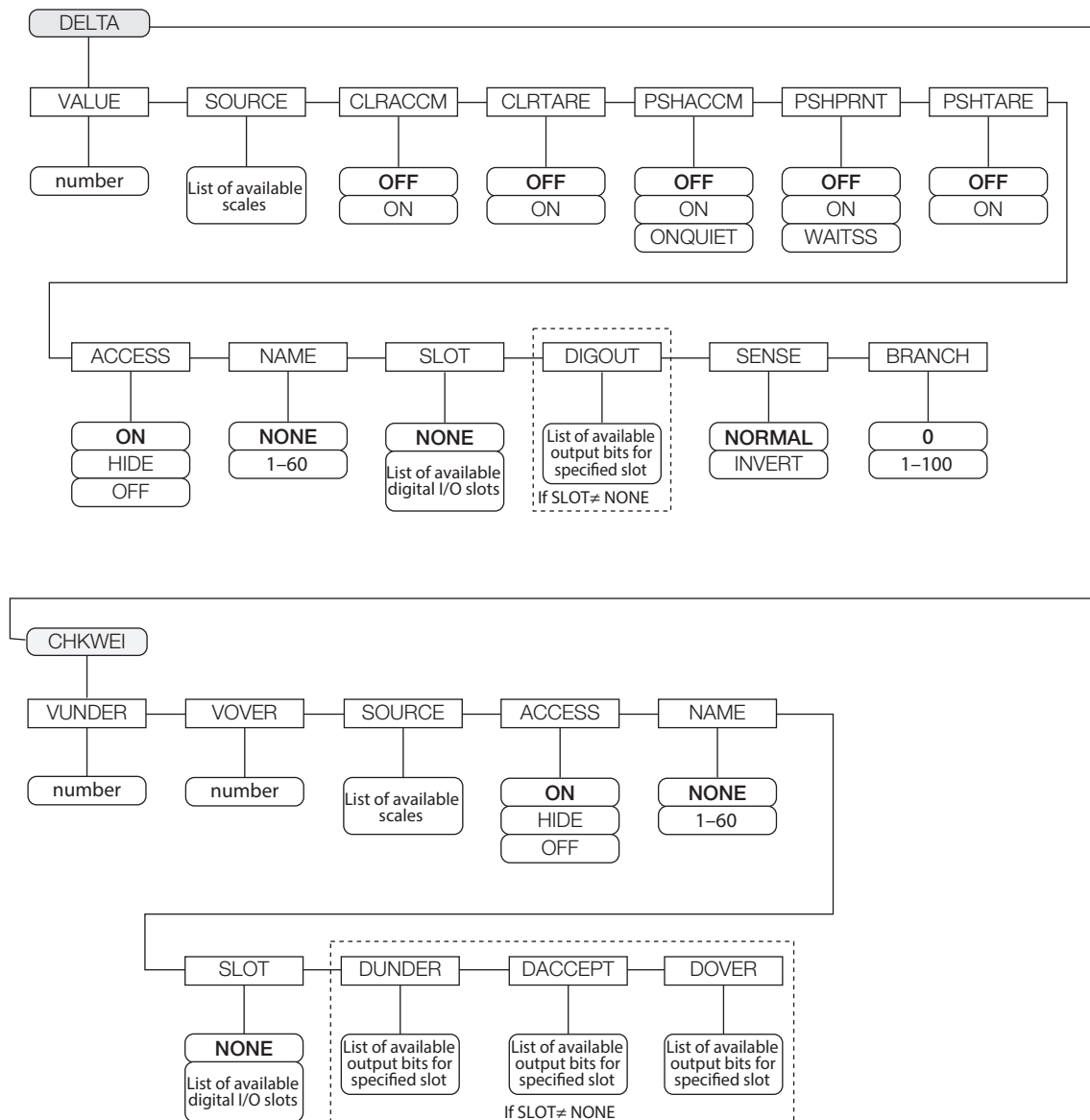

Figure 10-7. DELTA and CHKWEI Setpoint Parameters

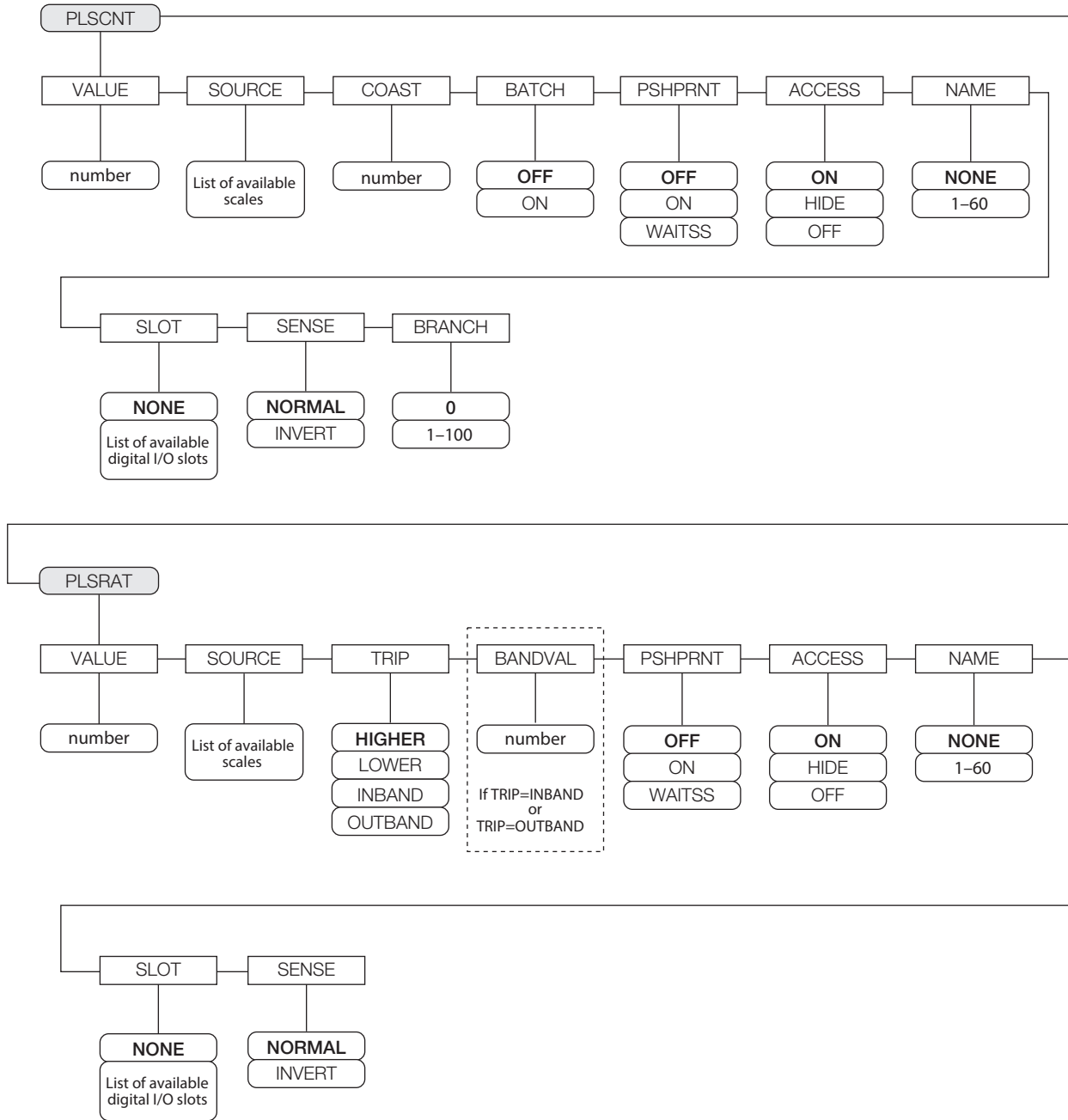

Figure 10-8. PLSCNT and PLSRAT Setpoint Parameters

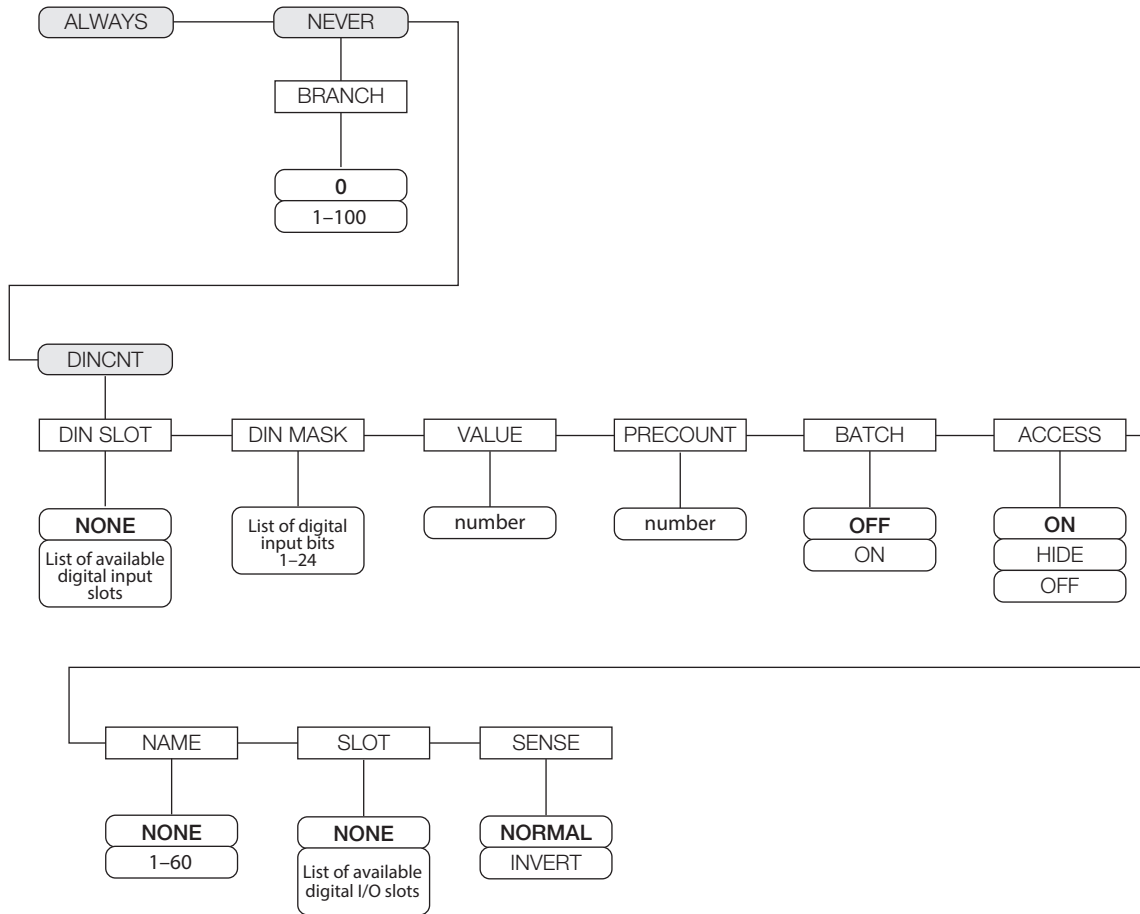

Figure 10-9. ALWAYS, NEVER, and DINCNT Setpoint Parameters

Parameter	Descriptions
VALUE	Setpoint Value – Enter a number <ul style="list-style-type: none"> For weight-based setpoints: specifies the target weight value, 0–9999999 For time-based setpoints: specifies, in 0.1-second intervals, a time value in the range 0–65535 For COUNTER setpoints: specifies the number of consecutive batches to be run, 0–65535 For PLSCNT setpoints: specifies a number of pulses, 0–9999999, received by a pulse input card For PLSRAT setpoints: specifies a pulse rate in Hz, 0–65535, received by a pulse input card
TRIP	Trip – Specifies whether the setpoint is satisfied when the weight is higher or lower than the setpoint value, within a band established around the value, or outside of that band; Settings: HIGHER (default), LOWER, INBAND, OUTBAND; In a batch sequence with TRIP=HIGHER, the associated digital output is active until the setpoint value is reached or exceeded; With TRIP=LOWER, the output is active until the weight goes below the setpoint value
BANDVAL	Band Value – Setpoints with TRIP=INBAND or OUTBAND, specifies a weight equal to half the band width; Band established around the setpoint value is VALUE ±BANDVAL; Enter value: 0–9999999
HYSTER	Hysteresis – Specifies a band around the setpoint value that must be exceeded before the setpoint, once off, can trip on again; Enter value: 0–9999999
PREACT	Preact – Allows the digital output associated with a setpoint to shut off before the setpoint is satisfied to allow for material in suspension; Settings: OFF (default) <ul style="list-style-type: none"> ON – Adjusts setpoint trip value up or down (depending on the TRIP parameter setting) from setpoint value using a fixed value specified on the PREVAL parameter LEARN – Can be used to automatically adjust the PREACT value after each batch; It compares the actual weight at standstill to the target setpoint value and adjusts the PREVAL by the PREADJ value times the difference after each batch FLOW – Provides dynamic compensation for material flow rate in determining when to shut off the digital output; Rather than waiting for the specified weight to be reached, FLOW uses the change in weight over time to anticipate when the TRIP minus PREACT weight value will be reached
PREVAL	Preact Value – Specifies the preact value for setpoints with PREACT set to ON, LEARN or FLOW; Depending on the TRIP setting specified for the setpoint, the setpoint trip value is adjusted up or down by the PREVAL value; Enter value: 0–9999999
PREADJ	Preact Adjustment Factor – Setpoints with PREACT set to LEARN, specifies a decimal representation of the percentage of error correction applied (0.5 = 50%, 1.0 = 100%) each time a PREACT adjustment is made; Enter value: 0–9999999, 0.500000 (default)
PRESTAB	Preact Stabilization Time-Out – Setpoints with PREACT set to LEARN, specifies the time, in 0.1-second intervals, to wait for standstill before adjusting the PREACT value; Setting this parameter to a value greater than zero disables the learn process if standstill is not achieved in the specified interval; Enter value: 0–65535, 0 (default)
PCOUNT	Preact Learn Interval – Setpoints with PREACT set to LEARN, specifies the number of batches after which the preact value is recalculated; Recalculates the preact value after every batch cycle; enter value: 0–65535, 1 (default)
TOLBAND	Tolerance band – Setpoints with TRIP set to HIGHER or LOWER, specifies a tolerance band around the target weight; If the captured weight is not within the specified tolerance band, the preact learn function is not applied and the batch is paused (based on the value of the TOLCNT parameter) until restarted or reset; Enter value: 0–9999999, 0 (default)
TOLCNT	Tolerance count – Setpoints with TRIP set to HIGHER or LOWER, specifies the number of consecutive batch cycles in which the tolerance band must be exceeded before the batch process is paused; When the specified value is met, the batch is paused and an error message is displayed; The batch must be restarted or reset to clear the error message; The special value of zero means that the batch is never paused for an out-of-tolerance condition; Enter value: 0–65535, 1 (default)
RELNUM	Relative Number – For relative setpoints, specifies the number of the relative setpoint; Enter value: 1–100; Target weight for this setpoint is determined as follows: <ul style="list-style-type: none"> REL setpoints, the value of the relative setpoint plus the value (VALUE parameter) of the +REL setpoint REL setpoints, the value of the relative setpoint minus the value of the –REL setpoint %REL setpoints, the percentage (specified on the VALUE parameter of the %REL setpoint) of the target value of the relative setpoint RESREL setpoints, the percentage (specified on the VALUE parameter of the RESREL setpoint) of the captured value of the relative setpoint
BATCH	Batch – Specifies whether the setpoint is used as a batch (ON) or continuous (OFF – default) setpoint
CLRACCM	Clear Accumulator – Specify ON (OFF – default) to clear the accumulator when the setpoint is satisfied
CLRTARE	Clear Tare – Specify ON (OFF – default) to clear the tare when the setpoint is satisfied
PSHACCM	Push Accumulator – Specify ON (OFF – default) to update the accumulator and perform a print operation when the setpoint is satisfied; Specify ONQUIET to update the accumulator without printing
PSHPRNT	Push Print – Specify ON (OFF – default) to perform a print operation when the setpoint is satisfied; Specify WAITSS to wait for standstill after setpoint is satisfied before printing

Table 10-3. Setpoint Parameters Descriptions

Parameter	Descriptions
PSHTARE	Specify ON (OFF – default) to perform an acquire tare operation when the setpoint is satisfied NOTE: PSHTARE acquires the tare regardless of the value specified for the REGULAT parameter on the FEATURE menu.
NOTE: If two or more of the CLR <i>xxxx</i> and PSH <i>xxxx</i> parameters are set on, the actions specified by those parameters are performed in the following order when the setpoint is satisfied: 1) clear accumulator; 2) clear tare; 3) accumulate; 4) print; 5) acquire tare	
ALARM	Specify ON (OFF – default) to display the word ALARM on the primary display while the setpoint is active (batch setpoints) or while the setpoint is not tripped (continuous setpoints)
START	Specifies starting setpoint number; do not specify number of the TIMER or CONCUR setpoint itself; TIMER or CONCUR setpoint begins when starting setpoint begins; Enter value: 1–100
END	Specifies ending setpoint number; do not specify number of the TIMER or CONCUR setpoint itself; TIMER or CONCUR setpoint stops when ending setpoint begins; Enter value: 1–100
ACCESS	Specifies the access allowed to setpoint parameters shown by pressing Setpoint softkey in normal mode: <ul style="list-style-type: none"> • ON (default): Values can be displayed and changed • HIDE: Values cannot be displayed or changed • OFF: Values can be displayed but not changed
NAME	Specify number of an assigned prompt; Up to 60 prompt names can be specified in the PROMPTS menu; enter value: 1–60, NONE (default)
SLOT	Lists all available digital I/O slots; this parameter specifies the slot number of the digital I/O card referenced by the DIGOUT parameter
DIGOUT	Lists all digital output bit numbers available for the specified SLOT; This parameter is used to specify the digital output bit associated with this setpoint; Use the DIG I/O menu to assign bit function to OUTPUT NOTE: For continuous setpoints, the digital output becomes active (low) when the condition is met; for batch setpoints, the digital output is active until the setpoint condition is met.
BRANCH	Specifies the setpoint number to which the batch sequence is to branch, if the current setpoint is not satisfied upon initial evaluation; Enter value: 1–100, 0 (default) indicates that no branch is taken
TIME	For TOD setpoints, specifies the time at which the setpoint becomes active; The format used to enter the time (12-hour or 24-hour) is based on the value specified for the TIMEFMT parameter
DURATION	For TOD setpoints; specifies the length of time that the digital output associated with this setpoint changes state; Value is entered in hours, minutes, and seconds (hh:mm:ss); All other operations associated with this setpoint (print, tare, or accumulate) are performed at the end of the specified duration
NSAMPLE	Number of Samples – For AVG setpoints; Specify the number of A/D samples used to calculate the average weight; Enter value 1–65535
SOURCE	Specify the scale number used as the source for the setpoint
DIN SLOT	Digital Input Slot – For DIGIN and DINCNT setpoints; Specify the slot number from which digital inputs will be read
DIN MASK	Digital Input Mask – For DIGIN and DINCNT setpoints; Specify the bits used as inputs to the setpoint; Use the Select softkey to select bits
VUNDER	Value Under – For CHKWEI setpoints; Specify the lower weight limit; Enter value: 0–9999999
VOVER	Value Over – For CHKWEI setpoints; Specify the upper weight limit; Enter value: 0–9999999
DUNDER	Digital Output Under – For CHKWEI setpoints; Specify the bit number of digital output activated when the scale weight is less than the VUNDER value specified
DACCEPT	Digital Output Accept – For CHKWEI setpoints; Specify the bit number of digital output activated when the scale weight between the VUNDER and VOVER values specified
DOVER	Digital Output Over – For CHKWEI setpoints; Specify the bit number of digital output activated when the scale weight is greater than the VOVER value specified
COAST	For PLSCNT setpoints; Specify the time delay (in 0.1 second intervals) inserted between reaching the setpoint target value and capture of the actual pulse count; Enter value: 0–65535
SENSE	Specifies whether the value of the digital output associated with this setpoint is inverted when the setpoint is satisfied; Settings: Normal (default), Invert

Table 10-3. Setpoint Parameters Descriptions (Continued)

10.3 Batch Operations

Softkeys can be configured to allow operator control of batch operations from the 920i front panel (Figure 10-10). Softkeys can be configured using iRev 4, serial commands or the FEATURE menu (Section 4.8 on page 46).

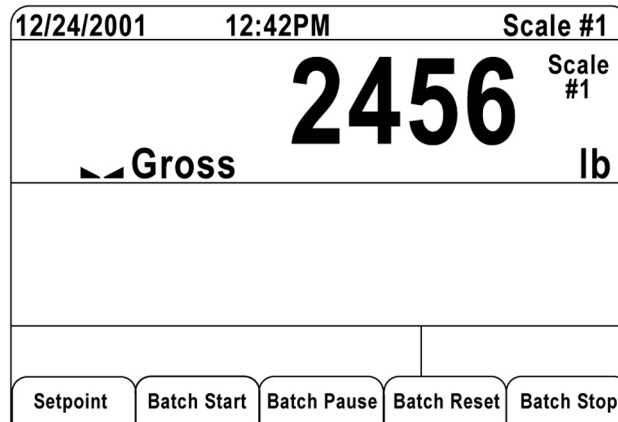

Figure 10-10. Batching Softkeys

Setpoint – Display or change assigned setpoints.

Batch Start – Starts batch process.

Batch Pause – Pauses an active batch and turns off all digital outputs except those associated with concurrent and timer setpoints. Processing is suspended until **Batch Start** is pressed again. Pressing **Batch Start** resumes the batch and re-energizes all digital outputs turned off by the **Batch Pause**.

Batch Reset – Stops and resets an active batch to the beginning of the process.

Batch Stop – Stops an active batch and turns off all associated digital outputs.



WARNING: To prevent personal injury and equipment damage, software-based interrupts must always be supplemented by emergency stop switches and other safety devices necessary for the application.

Batching Switch

The batching switch option, PN 19369, comes as a complete unit in an FRP enclosure, with legend plate, locking stop switch (mushroom button), and a run/start/abort 3-way switch.

Both switches are wired into the indicator's digital I/O terminal strip as shown in Figure 10-12 on page 99. Each switch uses a separate digital input.

Once cables and switches have been connected to the indicator, use the setup switch to place the indicator in setup mode. Use the digital I/O menu (Section 4.11 on page 53) to configure digital input and output functions.

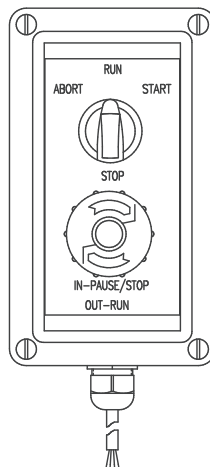
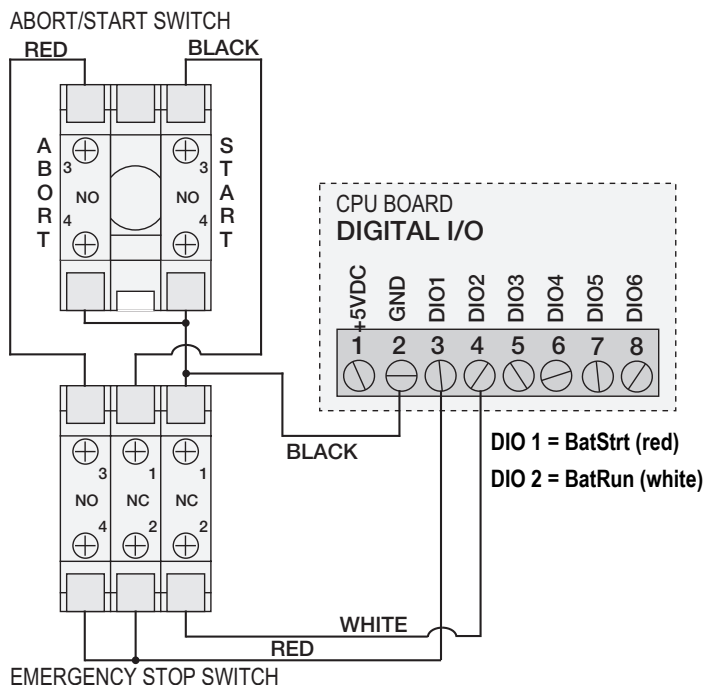

Figure 10-11. Batching Switch

When configuration is complete, exit setup mode. Initialize the batch by turning the 3-way switch to **ABORT** then unlock the **STOP** button (**STOP** must be in the OUT position to allow the batch process to run). The batching switch is now ready to use.

WARNING: If no digital input is assigned to **BATRUN**, batching proceeds as if **BATRUN** were always on: the batch starts when the 3-way switch is turned to **RUN** but the **STOP** mushroom button does not function.



E-Stop	Start/Abort	
Closed	Closed	Starts Batch (Also used as restart)
Closed	Open	--
Open	Closed	Aborts Batch
Open	Open	Pauses Batch

Table 10-4. BATRUN Information

Figure 10-12. Batching Switch Wiring Diagram Example

NOTE: If the Stop button is pushed in, it is in the open position.
If the Stop button is pulled out, it is in the closed position.

Digin		Softkey		Serial Command	Conditions	Notes
Start Digin	is the same as	Start	and	Batstart	*	Also used as restart
Reset Digin	is the same as	Reset	and	Batreset	**	--
Pause Digin	will Pause a batch deactivating digouts (with the exception of Type 1 Concur outputs)	Pause	and	Batpause	will Pause a batch deactivating Digouts (with the exception of Type 1 Concur outputs) until start is detected *	Batch continues when Pause Digin goes high
Stop Digin	is the same as	Stop	and	Batstop	will Pause a batch deactivating all digouts	--

* BatRun (if defined is closed)
** BatRun is open

Table 10-5. Digin vs Softkey Information

To begin a batch process, turn the 3-way switch to **START** momentarily. If the **STOP** button is pushed during the batch process, the process halts and the button locks in the IN position.

The **START** switch is ignored while the **STOP** button is locked in the IN position. The **STOP** button must be turned counterclockwise to unlock it, then released into the OUT position to enable the 3-way switch.

To restart an interrupted batch from the step where it left off:

1. Unlock STOP button (OUT position).
2. Turn 3-way switch to **START**.

To restart an interrupted batch from the first batch step:

1. Push the STOP button.
2. Turn 3-way switch to **ABORT**.
3. Unlock STOP button (OUT position).
4. Turn 3-way switch to **START**.

To abort an interrupted batch:

1. Push the **STOP** button.
2. Turn 3-way switch to **ABORT**.
3. Unlock STOP button (OUT position). A new batch can now be started.



NOTE: Use this procedure (or the **BATRESET** serial command) to initialize the new batch routine following any change to the setpoint configuration.

10.4 Batching Examples

Example 1

The following example is used to dispense 100-lb drafts, automatically refilling a hopper to 1000 lb gross weight once the gross weight has dropped below 300 lb.

Setpoint 1 ensures that the hopper has enough material to start the batch. If the hopper weight is 100 lb or higher, setpoint 1 is tripped.

```
SETPOINT=1
KIND=GROSS
VALUE=100
TRIP=HIGHER
BATCH=ON
ALARM=ON
```

Setpoint 2 waits for standstill, performs a tare, and puts the indicator into net mode.

```
SETPOINT=2
KIND=WAITSS
PSHTARE=ON
```

Setpoint 3 is used as a reference (relative setpoint) for setpoint 4.

```
SETPOINT=3
KIND=NET
VALUE=0
TRIP=HIGHER
BATCH=OFF
```

Setpoint 4 is used to dispense material from the hopper. When the hopper weight goes below 100 lb net the setpoint is tripped.

```
SETPOINT=4
KIND=-REL
VALUE=100
TRIP=LOW
BATCH=ON
DIGOUT=1
RELNUM=3
```

Setpoint 5 is used to evaluate the gross weight of material in the hopper after dispensing. When the hopper weight falls below 300 lb, digital output 2 becomes active and the hopper is refilled to 1000 lb.

```
SETPOINT=5
KIND=GROSS
VALUE=300
TRIP=HIGHER
HYSTER=700
BATCH=ON
DIGOUT=2
```

Setpoint 6 is used as a “no flow alarm”. If the process in setpoint 4 is not completed in 10 seconds, digital output 4 becomes active to signify a problem.

```
SETPOINT=6
KIND=TIMER
VALUE=100
START=4
END=5
DIGOUT=4
```

Example 2

The following example uses a CONCUR setpoint to provide a two-speed simultaneous fill of a hopper to a net weight of 1000 lb.

Setpoint 1 ensures that the gross weight is within 50 LB of gross zero.

```
SETPOINT=1
KIND=GROSS
VALUE=0
TRIP=INBAND
BANDVAL=50
BATCH=ON
```

Setpoint 2 performs a tare once the scale is at standstill.

```
SETPOINT=2
KIND=WAITSS
PSHTARE=ON
```

Setpoint 3 uses DIGOUT 1 to fill a hopper to a net weight of 800 lb.

```
SETPOINT=3
KIND=NET
VALUE=800
TRIP>HIGHER
BATCH=ON
DIGOUT=1
```

Setpoint 4 uses DIGOUT 2 to fill the hopper to a net weight of 1000 lb.

```
SETPOINT=4
KIND=NET
VALUE=1000
TRIP>HIGHER
BATCH=ON
DIGOUT=2
```

Setpoint 5 operates DIGOUT 2 while Setpoint 3 is active, providing simultaneous two-speed filling.

```
SETPOINT=5
KIND=CONCUR
VALUE=0
TRIP>HIGHER
START=4
END=5
DIGOUT=2
```

11.0 Serial Commands

The 920i indicator can be controlled by a personal computer or remote keyboard connected to an indicator serial port. Control is provided by a set of serial commands that can simulate front panel key press functions, display and change setup parameters and perform reporting functions. The serial commands provide the capability to print configuration data or to save that data to an attached personal computer. This section describes the serial command set and procedures for saving and transferring data using the serial ports.

11.1 The Serial Command Set

The serial command set can be divided into six groups:

- Key press commands
- USB commands
- Reporting commands
- **RESETCONFIGURATION** special function command
- Parameter setting commands
- Transmit weight data commands

When the indicator processes a serial command, it responds with the message **OK**, which verifies that the command was received and has been executed. If the command is unrecognized or cannot be executed, the indicator responds with **??**.

11.1.1 Key Press Commands

Key press commands simulate pressing the keys on the front panel of the indicator. These commands can be used in both setup and weigh mode.

There are also commands that serve as pseudo keys, providing functions that are not represented by a key on the front panel.

Example – to enter a 15-pound tare weight using serial commands:

1. Type K1 and press **Enter** (or **RETURN**).
2. Type K5 and press **Enter**.
3. Type KTARE and press **Enter**.

Command	Function
KBASE	Selects current scale; <i>Example: KBASE, K2, KENTER to select Scale #2</i>
KZERO	Presses Zero key in weigh mode
KGROSSNET	Presses Gross/Net key in weigh mode
KGROSS	Set to gross mode (pseudo key)
KNET	Set to net mode (pseudo key)
KTARE	Presses Tare key
KUNITS	Presses Units key in weigh mode
KPRIM	Set to primary units (pseudo key)
KSEC	Set to secondary units (pseudo key)
KTER	Set to tertiary units (pseudo key)
KPRINT	Presses Print key in weigh mode
KDISPACCUM	Presses Accum key
KDISPTARE	Displays tare (pseudo key)
KCLR	Presses Clear key
KCLRCON	Reset consecutive number (pseudo key)
KCLRTAR	Clears tare from system (pseudo key)
KLEFT	Move left in menu in setup mode
KRIGHT	Move right in menu in setup mode
KUP	Move up in menu in setup mode; scroll up to previously configured scale in weigh mode
KDOWN	Move down in menu in setup mode; scroll down to next configured scale in weigh mode
KSAVE	Saves current configuration in setup mode
KSAVEEXIT	Saves the current configuration in setup mode and exits to weigh mode

Table 11-1. Serial Key Press Commands

Command	Function
KCLRNV	Clears non-volatile RAM in setup mode
K0–K9	Presses number 0 (zero) through 9
KDOT	Presses decimal point (.)
KENTER	Presses Enter key
KSOFTx	Presses softkey number x
KLOCK	Locks specified front panel key; <i>Example: enter KLOCK=KZERO to lock the Zero key</i>
KUNLOCK	Unlock specified front panel key; <i>Example: enter KUNLOCK=KPRINT to unlock the Print key</i>
KID	Displays Unit ID entry screen
KTREG	Displays truck register
KWIN	Processes truck weigh-in transaction <i>Example: KWIN, K2, K3, KENTER to select ID #23</i>
KWOUT	Processes truck weigh-out transaction
KDEL	Delete truck register while it is displayed
KSETPOINT	Displays setpoint configuration (pseudo key)
KDATE	Displays date (pseudo key)
KTIME	Displays time (pseudo key)
KTIMEDATE	Displays time and date (pseudo key)

Table 11-1. Serial Key Press Commands (Continued)

11.1.2 USB Commands

Command	Function
USB.INSTALLED	Returns TRUE when a USB interface card is installed; Settings: TRUE, FALSE
USB.DEVICE	Returns configured device from the last Save and Exit; must be in setup mode to be changed
USB.DEVICE.LOAD	Applies the configured device selected from the USB.DEVICE command
USB.DEVICE.CURRENT	Returns the current device

Table 11-2. USB Commands

11.1.3 Reporting Commands

Reporting commands send specific information to the serial port. The commands listed in [Table 11-3](#) can be used in either setup or weigh mode.

Command	Function
DUMPALL	List all parameter values
SPDUMP	Print setpoint configuration
VERSION	Write 920i software version
HARDWARE	Lists option cards installed in slots 1–14 (Section 12.1.2 on page 125)
HWSUPPORT	Reports the CPU part number (67612 and 109549 have driver for CCFL B/L, 108902 has driver for LED B/L)
XE	Returns 10-digit code representing error conditions currently shown on the front panel (Section 12.1.4 on page 127)

Table 11-3. Reporting Commands

11.1.4 Clear and Reset Commands

The following commands can be used to clear and reset the 920i:

Command	Function
PCLR	Program Clear. Erases the loaded user program (setup mode only)
RS	Reset system. Resets the indicator without resetting the configuration
RESETCONFIGURATION	Restores all configuration parameters to their default values (setup mode only)
RESETCONFIGURATION	function can also be initiated by pressing the Reset Config softkey under the VERSION menu

Table 11-4. Clear and Reset Commands

Use the **Up** key to select **Clear entire indicator configuration**. Press **Enter** to reset the indicator.



IMPORTANT: All load cell calibration settings are lost when the **RESETCONFIGURATION** command is run.

11.1.5 Parameter Setting Commands

Parameter setting commands allow the display or change of the current value for a particular configuration parameter (Table 11-5 on page 106–Table 11-14 on page 113).

Current configuration parameter settings can be displayed in either setup mode or weigh mode using the following syntax:

```
command<ENTER>
```

Most parameter values can be changed in setup mode only; setpoint parameters listed in Table 11-8 on page 110 can be changed when in weigh mode.

Use the following command syntax when changing parameter values:

```
command=value<ENTER>
```

where value is either a number or a parameter value. Do not use spaces before or after the equal (=) sign. If an incorrect command is typed, ?? displays.

Example, to set the motion band parameter on Scale #1 to 5 divisions, type the following:

```
SC.MOTBAND#1=5D<ENTER>
```

For parameters with selectable values, enter the command and equal sign followed by a question mark to see a list of those values. The indicator must be in setup mode to use this function.

```
command=?<ENTER>
```



NOTE: Some parameters are valid only if other parameters or parameter values are specified. See the configuration menus in Section 4.0 on page 27 for information about parameter dependencies. Restrictions for front-panel configuration also apply to serial command configuration.

Command	Descriptions	Values
SC.SRC#n	Scale source	Specify Scale Source as: SC.SRC#n = y, z.a y – Scale type: A – A/D scale B – Analog input S – Serial scale or iQUBE ² T – Total scale P – Program scale z – Port number (for serial scale or iQUBE ² only) .a – iQUBE ² system identifier (defaults to 1)
SC.GRADS#n	Graduations	1–9999999
SC.SPLIT#n	Multi-range/multi-interval scale type	OFF, 2RNG, 3RNG, 2INTVL, 3INTVL
SC.ZTRKBN#n	Zero track band	0 (default), 0–100
SC.ZRANGE#n	Zero range	1.900000 (default), 0–100
SC.MOTBAND#n	Motion band	1 (default), 0–100
SC.SSTIME#n	Standstill time	1–65535,
SC.OVRLOAD#n	Overload	FS+2%, FS+1D, FS+9D, FS
SC.WMTTHR#n	Weighment threshold	grads
SC.NUMWEIGH#n	Number of weighments	—
SC.MAX_WEIGHT#n	Maximum weight	—
SC.DIGFLTR1#n SC.DIGFLTR2#n SC.DIGFLTR3#n	Digital filtering	1, 2, 4, 8, 16, 32, 64, 128, 256
SC.DFSENS#n	Digital filter cutout sensitivity	2OUT, 4OUT, 8OUT, 16OUT, 32OUT, 64OUT, 128OUT
SC.DFTHR#n	Digital filter cutout threshold	NONE, 2D, 5D, 10D, 20D, 50D, 100D, 200D, 250D
SC.RATLTRAP#n	Rattletrap filtering	OFF, ON
SC.SMPRAT#n	Sample rate	30HZ, 60HZ, 120HZ, 240HZ, 480HZ, 960HZ
SC.PWRUPMD#n	Power up mode	GO, DELAY
SC.TAREFN#n	Tare function	BOTH, NOTARE, PBTARE, KEYED
SC.PRI.DECPNT#n	Primary units decimal position	8.888888, 88.888888, 888.8888, 8888.888, 88888.88, 888888.8, 8888888, 8888880, 8888800
SC.PRI.DSPDIV#n	Primary units display divisions	1D, 2D, 5D
SC.PRI.UNITS#n	Primary units	LB, KG, G, OZ, TN, T, GN, TROYOZ, TROYLB, LT, CUSTOM, NONE, OFF
SC.PRI.CUNITS#n	Primary custom units	Specify units if SC.PRI.UNITS=CUSTOM
SC.SEC.DECPNT#n	Secondary units decimal position	8.888888, 88.888888, 888.8888, 8888.888, 88888.88, 888888.8, 8888888, 8888880, 8888800
SC.SEC.DSPDIV#n	Secondary units display divisions	1D, 2D, 5D
SC.SEC.UNITS#n	Secondary units	LB, KG, G, OZ, TN, T, GN, TROYOZ, TROYLB, LT, CUSTOM, NONE, OFF
SC.SEC.CUNITS#n	Secondary custom units	Specify units if SC.SEC.UNITS=CUSTOM
SC.SEC.MULT#n	Secondary units multiplier	0.00000–9999999
SC.TER.UNITS#n	Tertiary units	LB, KG, G, OZ, TN, T, GN, TROYOZ, TROYLB, LT, CUSTOM, NONE, OFF
SC.TER.CUNITS#n	Tertiary custom units	Specify units if SC.TER.UNITS=CUSTOM
SC.TER.DECPNT#n	Tertiary units decimal position	8.888888, 88.888888, 888.8888, 8888.888, 88888.88, 888888.8, 8888888, 8888880, 8888800
SC.TER.DSPDIV#n	Tertiary units display divisions	1D, 2D, 5D
SC.TER.MULT#n	Tertiary units multiplier	0.000001–9999999
SC.ROC.DECPNT#n	Tertiary units decimal position	8.888888, 88.888888, 888.8888, 8888.888, 88888.88, 888888.8, 8888888, 8888880, 8888800
SC.ROC.DSPDIV#n	Rate-of-change units display divisions	1D, 2D, 5D
SC.ROC.MULT#n	Rate-of-change units multiplier	0.000001–9999999
SC.ROC.UNITS#n	Rate-of-change units	SEC, MIN, HOUR
SC.ROC.INTERVL#n	Rate-of-change interval	1–100
SC.ROC.REFRESH#n	Rate-of-change refresh interval	0.1–60
SC.RANGE1.MAX#n	Weight maximum for first range or interval	weight
SC.RANGE2.MAX#n	Weight maximum for second range or interval	weight
SC.RANGE3.MAX#n	Weight maximum for third range or interval	weight
SC.ACCUM#n	Accumulator enable	ON, OFF

Table 11-5. SCALES Serial Commands

Command	Descriptions	Values
SC.VISIBLE#n	Scale visibility	ON, OFF
SC.PEAKHOLD#n	Peak hold	OFF, NORMAL, BI-DIR, AUTO
SC.WZERO#n	Zero calibration	—
SC.WVAL#n	Test weight value	test_weight_value
SC.WSPAN#n	Span calibration	—
SC.WLIN.F1#n– SC.WLIN.F5#n	Actual raw count value for linearization points 1–5	0–16777215
SC.WLIN.V1#n– SC.WLIN.V5#n	Test weight value for linearization points 1–5	0.000001–9999999
SC.WLIN.C1#n– SC.WLIN.C5#n	Calibrate linearization points 1–5	—
SC.LC.CD#n	Deadload coefficient	—
SC.LC.CW#n	Span coefficient	—
SC.LC.CZ#n	Temporary zero	—
SC.REZERO#n	Rezero	—
For commands ending with #n, n is the scale number		

Table 11-5. SCALES Serial Commands (Continued)

Command	Descriptions	Values
EDP.INPUT#p	Port serial input function	CMD, KEYBD, KBDPRG, SCALE, IND SC, DISPLAY, IQUBE ² ; see the iQUBE ² Installation Manual (PN 106113) for more information on configuring iQUBE serial scales
EDP.BAUD#p	Port baud rate	300, 600, 1200, 2400, 4800, 9600, 19200, 28800, 38400, 57600, 115200
EDP.BITS#p	Port data bits/parity	8NONE, 7EVEN, 7ODD, 8ODD, 8EVEN
EDP.TERMIN#p	Port termination character	CR/LF, CR
EDP.STOPBITS#p	Port stop bits	2, 1
EDP.ECHO#p	Port echo	ON, OFF
EDP.RESPONSE#p	Port response	ON, OFF
EDP.EOLDLY#p	Port end-of-line delay	0–255 (0.1-second intervals)
EDP.HANDSHK#p	Port handshaking	OFF, XONXOFF, HRDWAR
EDP.TYPE#p	Port type	232, 485
EDP.DUPLEX#p	Port RS-485 duplex	HALF, FULL
EDP.ADDRESS#p	Port RS-485 address	0, 1–255
EDP.STREAM#p	Port streaming	OFF, LFT, INDUST, 4KEYS, KEYPAD, DISPLAY
EDP.SOURCE#p	Port source scale for output	scale_number
EDP.SFMT#p	Port custom stream format	0-50 characters
STR.POS#p	Custom stream identifiers	Specify replacement text for token; <i>Example: STR.PRI#1=L</i> See Section 4.7.8 on page 44 for more information about custom stream formatting
STR.NEG#p		
STR.PRI#p		
STR.SEC#p		
STR.TER#p		
STR.GROSS#p		
STR.NET#p		
STR.TARE#p		
STR.MOTION#p		
STR.RANGE#p		
STR.OK#p		
STR.INVALID#p		
STR.ZERO#p		
For commands including “#p”, p is the serial port number		

Table 11-6. SERIAL Port Serial Commands

Command	Descriptions	Values
SD	Set date	MMDDYY, DDMMYY, YYMMDD, or YYDDMM: enter six-digit date using the year-month-day order specified for the DATEFMT parameter, using only the last two digits of the year
ST	Set time	hhmm (enter using 24-hour format)
DATEFMT	Date format	MMDDYYYY, DDMMYYYY, YYYYMMDD, YYYYDDMM
DATESEP	Date separator	SLASH, DASH, SEMI
TIMEFMT	Time format	12HOUR, 24HOUR
TIMESEP	Time separator	COLON, COMMA
DECfmt	Decimal format	DOT, COMMA
DSPRATE	Display rate	1–80, in 100-ms intervals
CONSNUM	Consecutive numbering	0–9999999
CONSTUP	Consecutive number start-up value	0–9999999
UID	Unit identifier	aaaaaaaa (up to 8 alphanumeric characters)
TRUCK	Truck in/out mode	OFF, MODE1, MODE2, MODE3, MODE4, MODE5, MODE6
ALIBI	Alibi data storage	OFF, ON
CONTRAST	Adjusts the contrast level	0–127
CFGPWD	Configuration password	0, 1–9999999
SPPWD	Setpoint password	0, 1–9999999
SK#1–SK#32	Softkey assignment	Blank, TimeDate, DspTar, DspAcc, DspROC, SetPt, BatStrt, BatStop, BatPause, BatRst, WeighIn, WeighOut, TrkReg, UID, SclSel, Diagnostics, Alibi, Contrast, Test, Stop, Go, SKUD1–SKUD10
SKT#1–SKT#10	User-defined softkey text	—
KYBDLK	Keyboard lock (disable keypad)	OFF, ON
ZERONLY	Disable all keys except ZERO	OFF, ON
PROMPT#1–PROMPT#60	Prompts/setpoint names	—
REGULAT	Regulatory compliance	NONE, OIML, NTEP, CANADA, INDUST
REG.SNPSHOT	Display or Scale weight source	DISPLAY, SCALE
REG.HTARE	Allow tare in display hold	NO, YES
REG.ZTARE	Remove tare on ZERO	NO, YES
REG.KTARE	Always allow keyed tare	NO, YES
REG.MTARE	Multiple tare action	REPLACE, REMOVE, NOTHING
REG.NTARE	Allow negative tare	NO, YES
REG.CTARE	Allow clear keyed tare	NO, YES
REG.RTARE	Round pushbutton tare to nearest display division	NO, YES
REG.CHILDZT	Clear child scales individually	NO, YES
REG.NEGTOTAL	Allow total scale to display negative value	NO, YES
REG.PRTMOT	Allow print while in motion	NO, YES
REG.PRINTPT	Add PT to keyed tare print	NO, YES
REG.PRTHLD	Print during display hold	NO, YES
REG.HLDWGH	Allow weighment during display hold	NO, YES
REG.MOTWGH	Allow weighment in motion	NO, YES
REG.OVRBASE	Zero base for overload calculation	CALIB ZERO, SCALE ZERO
REGWORD	Regulatory word	GROSS, BRUTTO
CONTACT.COMPANY	Contact company name	company_name (up to 30 characters)
CONTACT.ADDR1-3	Contact company address	company_address (up to 30 characters for each line)
CONTACT.NAME1-3	Contact names	contact_names (up to 20 characters each)
CONTACT.PHONE1-3	Contact phone numbers	contact_phone_numbers (up to 20 characters each)
CONTACT.EMAIL	Contact e-mail address	contact_e-mail_address (up to 30 characters)
CONTACT.NEXTCAL	Next calibration date	calibration_date
GRAVADJ	Gravitational adjustment	OFF, ON
LAT.LOC	Latitude	0–90 (to nearest degree of latitude)
ELEV.LOC	Elevation	±0–9999 (in meters)
IMAGE	Display image	NEGATIVE, POSITIVE

Table 11-7. FEATURE Serial Commands

Command	Descriptions	Values
SP.KIND#n	Setpoint kind	OFF, GROSS, NET, -GROSS, -NET, ACCUM, ROC, +REL, -REL, %REL, RESREL, PAUSE, DELAY, WAITSS, COUNTER, AUTOJOG, COZ, INMOTON, INRANGE, BATCHPR, TIMER, CONCUR, DIGIN, AVG, TOD, DELTA, CHWEI, PLSCNT, PLSRAT, ALWAYS, NEVER, DINCNT
SP.VALUE#n	Setpoint value	Number
SP.SOURCE#n	Source scale	SCALE1, SCALE2, SCALE3...SCALEx
SP.COAST#n	Pulse counter coast	Number
SP.TRIP#n	Trip	HIGHER, LOWER, INBAND, OUTBAND
SP.BANDVAL#n	Band value	Number
SP.HYSTER#n	Hysteresis	Number
SP.PREACT#n	Preact type	OFF, ON, LEARN, FLOW
SP.PREVAL#n	Preact value	Number
SP.PREADJ#n	Preact adjustment percentage	Number
SP.PRESTAB#n	Preact learn stability	Number
SP.PCOUNT#n	Preact learn interval	Number
SP.TOLBAND#n	Target tolerance	Number
SP.TOLCNT#n	Tolerance count	Number
SP.BATCH#n	Batch step enable	OFF, ON
SP.CLRACCM#n	Clear accumulator enable	OFF, ON
SP.CLRTARE#n	Clear tare enable	OFF, ON
SP.PSHACCM#n	Push accumulate	OFF, ON, ONQUIET
SP.PSHPRINT#n	Push print	OFF, ON, WAITSS
SP.PSHTARE#n	Push tare	OFF, ON
SP.ALARM#n	Alarm enable	OFF, ON
SP.NAME#n	Setpoint name number	NONE, 1-60
SP.ACCESS#n	Setpoint access	OFF, ON, HIDE
SP.DSLOT#n	Digital output slot	NONE, SLOTx
SP.DIGOUT#n	Digital output	BITx
SP.SENSE#n	Digital output sense	NORMAL, INVERT
SP.BRANCH#n	Branch destination	0, 1-100
SP.RELNUM#n	Relative setpoint number	1-100
SP.START#n	Starting setpoint	1-100
SP.END#n	Ending setpoint	1-100
SP.DISLOT#n	Digital input slot	NONE, SLOTx
SP.MASK#n	Digital input mask	Number
SP.NSAMPLE#n	Number of samples	Number
SP.TIME#n	Trip time	hhmm
SP.DURATION#n	Trip duration	hhmmss
SP.VUNDER#n	Underrange value	Number
SP.VOVER#n	Overrange value	Number
SP.DUNDER#n	Underrange digital output	BITx
SP.DACCEPT#n	Accept digital output	BITx
SP.DOVER#n	Overrange digital output	BITx
BATCHNG	Batching mode	OFF, AUTO, MANUAL
SP.ENABLE#n	Setpoint enable ON, OFF	

For setpoint commands ending with "#n", n is the setpoint number.

Table 11-8. SETPNTS Serial Commands

Command	Descriptions	Values
GFMT.FMT GFMT.PORT	Gross demand print format string	For .PORT commands, specify the port number as PORT xx (no leading zero) Example: GFMT.PORT=PORT3
NFMT.FMT NFMT.PORT	Net demand print format string	For AUXFMT.FMT and .PORT commands, specify the auxiliary format number (1—20) as .FMT# nn or .PORT# nn (no leading zero) Example: AUXFMT.FMT#8=GROSS<G><NL2>...
ACC.FMT ACC.PORT	Accumulator print format string	
SPFMT.FMT SPFMT.PORT	Setpoint print format string	See Section 8.0 on page 75 for information about demand print format strings
TRWIN.FMT TRWIN.PORT	Truck weigh-in print format string	See the iQUBE ² Installation Manual (PN 106113) for more information about alert formats
TRWOUT.FMT TRWOUT.PORT	Truck weigh-out print format string	
TR.FMT TR.PORT	Truck register print format string	
ALERT.FMT ALERT.PORT	Alert format string	
HDRFMT1 HDRFMT2	Ticket header format strings	
AUXFMT.FMT# nn AUXFMT.PORT# nn	Auxiliary ticket format	
AUD.PORT	Audit trail port	
WDGT# n	Display widget	widget_number; see Section 11.2 on page 116 for widget programming information
WDGT.CLR	Clear widgets	—

Table 11-9. PFORMT Serial Commands

Command	Descriptions	Values
DON. $b#s$	Set digital output on (active) at bit b , slot s	—
DOFF. $b#s$	Set digital output off (inactive) at bit b , slot s	—
DIO. $b#s$	Digital input function	OFF, INPUT, OUTPUT, PROGIN, ZERO, NT/GRS, TARE, UNITS, PRINT, ACCUM, SETPNT, TIMDATE, ESC, CLEAR, DSPTAR, IDKEY, KEY0–KEY9, KEYDP, ENTER, NAVUP, NAVDN, NAVLFT, NAVRGT, KBDLOC, HOLD, BATRUN, BATSTRT, BATPAUS, BATRESET, BATSTOP, CLRCN, GROSS, NET, PRIM, SEC, CLRTAR, CLRACC, TRIGGER
DIO.TRIG_SLOT. $b#s$	Trigger output slot	NONE, SLOT3
DIO.TRIG_PARAM. $b#s$	Trigger output parameter	Value
Digital inputs and outputs are specified by bit number (b) and slot number (s)		

Table 11-10. DIG I/O Serial Commands

Command	Descriptions	Values
ALG.ALIAS#s	Analog output alias	Name
ALG.SOURCE#s	Analog output source	PROG, SCALEn
ALG.MODE#s	Mode	GROSS, NET
ALG.OFFSET#s	Zero offset	0%, 20%
ALG.ERRACT#s	Error action	FULLSC, HOLD, ZEROSC
ALG.MIN#s	Minimum value tracked	0-9999999
ALG.MINNEG#n	Minimum value is negative	OFF, ON
ALG.MAX#s	Maximum value tracked	0-9999999
ALG.MAXNEG#n	Maximum value is negative	OFF, ON
ALG.ZERO#s	Zero calibration	0-65535
ALG.SPAN#s	Span calibration	0-65535

For commands ending with #s, s is the slot number; for dual-channel analog output cards, channel 2 is assigned to ALGOUTs+14;
Example: Channel 2 of a dual analog output card in Slot 3 is assigned ALGOUT17

Table 11-11. ALGOUT Serial Commands (Valid Only If Analog Output Card Is Installed)

Command	Descriptions	Values
FB.BYTESWAP#s	Swap data bytes	NONE, BYTE, WORD, BOTH
FB.SIZE#s	Number of bytes to transfer	2-128

For commands ending with #s, s is the slot number

Table 11-12. FLDBUS Serial Commands (Valid Only If Fieldbus Card Is Installed)

Command	Descriptions	Values
XP#s	Extract probe temperature	—
XPP#s	Extract probe primary temperature	
XPS#s	Extract probe secondary temperature	
XPT#s	Extract probe tertiary temperature	
XI#s	Extract 0–20 mA value	
XV#s	Extract 0–10 V value	

For commands ending with #s, s is the slot number

Table 11-13. Analog Input Serial Commands (Valid Only If Analog Input Card Is Installed)

11.1.6 Normal Mode Commands

The normal mode print commands transmit data to the serial port on demand in either setup or normal mode (Table 11-14).

Command	Descriptions	Values
CONSUM	Set consecutive number	0–9 999 999
UID	Set unit ID	nnnnnnn
SD	Set date	MMDDYY, DDDMMYY, YYMMDD, or YYDDMM ; enter six-digit date using the year-month-day order specified for the DATEFMT parameter, using only the last two digits of the year
ST	Set time	hhmm (enter using 24-hour format)
SX#n	Start serial port streaming	OK or ??
EX#n	Stop serial port streaming	The port streaming parameter (EDP.STREAM#p) for the streaming port must be set to LFT or INDUST before using these commands; an EX command sent while in setup mode does not take effect until the indicator is returned to normal mode
RS	Reset system	Soft reset; used to reset the indicator without resetting the configuration to the factory defaults
SF#n	Transmit single frame of stream	Returns a single stream frame from scale n
XA#n	Transmit accumulator value in displayed units	nnnnnn UU
XAP#n	Transmit accumulator value in primary units	
XAS#n	Transmit accumulator value in secondary units	
XAT#n	Transmit accumulator value in tertiary units	
XG#n	Transmit gross weight in displayed units	
XGP#n	Transmit gross weight in primary units	nnnnnn UU
XGS#n	Transmit gross weight in secondary units	
XGT#n	Transmit gross weight in tertiary units	
XN#n	Transmit net weight in displayed units	
XNP#n	Transmit net weight in primary units	nnnnnn UU
XNS#n	Transmit net weight in secondary units	
XNT#n	Transmit net weight in tertiary units	
XT#n	Transmit tare weight in displayed units	
XTP#n	Transmit tare weight in primary units	nnnnnn UU
XTS#n	Transmit tare weight in secondary units	
XTT#n	Transmit tare weight in tertiary units	
XE	Query system error conditions	

Table 11-14. Normal Mode Serial Commands

11.1.7 Batching Control Commands

The commands listed in Table 11-15 provide batching control through the serial port.

Command	Descriptions	Values
BATSTART	Batch start	If the BATRUN digital input is active (low) or not assigned, the BATSTART command can be used to start the batch program
BATSTOP	Batch stop	Stops the batch program and turns off all associated digital outputs
BATPAUSE	Batch pause	Stops the batch program at the current step; all digital outputs set on by the current step (except for those set by concur setpoints) are set off; the BATSTRT DIGIN, BATSTART serial command, Batch Start softkey, or the StartBatch function in an iRite program can be used to restart the batch program at the current step
BATRESET	Batch reset	Stops the program and resets the batch program to the first batch step; run the BATRESET command after making changes to the batch configuration
BATSTATUS	Batch status	Returns XYYY where X is S (if the batch is stopped), P (if the batch is paused), R (if the batch is running); and YYY is the setpoint number the batch is currently on (1–100)

Table 11-15. Batching Control Commands

11.1.8 Database Commands

The commands listed in [Table 11-16](#) can be used to create and maintain databases in the 920i. Except for the `db.delall` command, all of the database commands require an extension to identify the number of the database within the memory card and the slot number of the memory card.

Command	Descriptions
DB.ALIAS.n#x	Get or set database name
DB.CLEAR.n#x	Clear database contents
DB.DATA.n#x	Get or set database contents
DB.SCHEMA.n#x	Get or set database structure
db.delall	Delete all databases and database contents
n represents the database number within the memory card; x is the slot number of the memory card	
Each command must be terminated with a carriage return character (<CR>, ASCII 13)	

Table 11-16. Database Commands

db.alias

The **db.alias** command is used to get or set the alias used by iRite programs to reference the specified database. Each database alias must be unique among all databases and adhere to the following rules: 8 character maximum; must begin with an alpha character or an underscore; can only contain A–Z, a–z, 0–9 or an underscore (_).

Example: The following command assigns an alias of TRUCKS_2 to the first database on the memory card installed in slot 2:

```
DB.ALIAS.1#2=TRUCKS_2<CR>
```

Sending the **db.alias** command alone, without assigned data, returns the current database alias.

db.clear

To clear the contents of a database, send the following command:

```
DB.CLEAR.n#x<CR>
```

Where:

n is the database number on the memory card

x is the slot number of the memory card (0 is the onboard memory)

OK<CR> displays if clear is successful, **??<CR>** displays if unsuccessful.

db.data

Used to send data to or retrieve data from the 920i.

Data can be sent to the indicator using the following command:

```
DB.DATA.n#x = data{ | }<CR>
```

Where:

n is the database number on the memory card

x is the slot number of the memory card (0 is the onboard memory)

data represents a single cell of a row of data

{ | } is an ASCII pipe character (decimal 124), used to delimit cell data.

- If the data being sent is not the last cell of the row, append the pipe character to the data to indicate that more data is coming for that particular row.
- If the data being sent is the last cell of the row, do not append the pipe character.

OK<CR> displays if clear is successful, **??<CR>** displays if unsuccessful.

Example: The following commands place the data from [Table 11-18](#) into the first database in the onboard memory:

First Record	Second Record
DB.DATA.1#0=this <CR>	DB.DATA.1#0=aaa <CR>
DB.DATA.1#0=is <CR>	DB.DATA.1#0=bbb <CR>
DB.DATA.1#0=a <CR>	DB.DATA.1#0=ccc <CR>
DB.DATA.1#0=test <CR>	DB.DATA.1#0=ddd <CR>

Table 11-17. Onboard Memory Commands

Record	Cell			
	1	2	3	4
First	this	is	a	test
Second	aaa	bbb	ccc	ddd

Table 11-18. Sample Database Contents

Sending the **db.data** command alone, without assigned data, returns the database contents:

```
DB.DATA.n#x<CR>
```

The entire contents of the database is returned as cell-delimited with the pipe character (ASCII 124) and row-delimited with carriage returns (ASCII 13).

Example: this following command could be used to return the contents of database 1 on the onboard memory:

```
DB.DATA.1#0<CR>
```

If the database contents were the records from [Table 11-18](#), the indicator responds with the following data, using pipe characters and carriage returns to delimit the database cells and rows.

```
this|is|a|test<CR>aaa|bbb|ccc|ddd<CR>
```



NOTE: There is no end of database notification at the end of the **db.data** command transmission. Use a receive time-out to determine command completion. The time-out value varies based on baud rate.

Determine the number of records currently in the database both prior to and after sending the **db.data** command to verify that the correct number of records are received. The number of records can be determined with the **db.schema** command.



NOTE: The 62K of onboard (slot 0) memory can be allocated to up to eight auxiliary databases. However, the size of any one database may limit the size and number of other databases.

db.schema

The **db.schema** command is used to get or set the structure of a database.

```
DB.SCHEMA.n#x<CR>
```

The 920i responds to the command above by returning the following:

```
<Max Records>,<Current Record Count>,  
<Column Name>,<Data Type>,<Data Size>,...<CR>
```

The **<Column Name>**, **<Data Type>**, and **<Data Size>** elements repeat for each column in the database.

The **<Column Name>** follows the rules for alias names:

- 8 character maximum
- Must begin with an alpha character or an underscore
- Can only contain A–Z, a–z, 0–9 or an underscore (_)

The **<Data Type>** is represented by a numeric field:

Value	Type	Value	Type
1	Byte	5	Double (64-bit floating point)
2	Short (16-bit integer)	6	Fixed string
3	Long (32-bit integer)	7	Variable string
4	Single (32-bit floating point)	8	Date and time

Table 11-19. Data Type Field Codes

The <Data Size> value must match the data type. A range of data size values is allowed only for the string data types:

Size	Value
Byte	1
Short	2
Long	4
Single	4
Double	8
Fixed string	1–255
Variable string	1–255
Date and time	8

Table 11-20. Data Size Field Codes

The **db.schema** command can also be used to modify the schema, but only when the indicator is in setup mode and only if the database does not contain any data.

11.2 Widget Programming

The type and location of elements shown on the 920i display are easily specified using the drag and drop features of the iRev 4 utility. However, display widgets can also be programmed using serial commands while the 920i is in setup mode, or through iRite programming. Up to ten different screens can be configured.

Serial command widget programming is accomplished in setup mode, using the WDG T serial command. The first parameter specified is the widget type, listed in Table 11-21. The following sections describe each of the widget types and the parameters and values specific to that type.

In setup mode, the WDG T.CLR serial command can be used to clear all specified widgets from the display.

Type	Descriptions
1	Scale Widget
2	Bitmap Widget
3	Bargraph Widget
4	Label Widget
5	Numeric Widget
6	Symbol Widget

Table 11-21. Widget Types

Some widget types require that the location or size of the widget be specified, in pixels. Figure 11-1 shows the pixel counts (80 pixels per inch) used to specify the pixel location on the display.

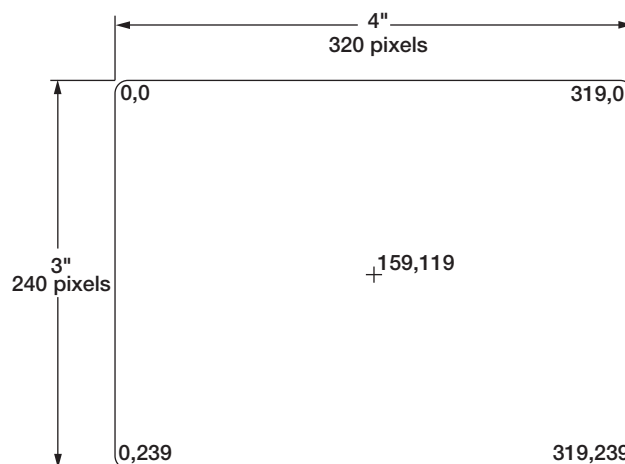

Figure 11-1. Screen Location Pixel Values

Setting the **data_source** of bar graph, label, numeric, and symbol widgets to 2 (program) allows these widget types to be directly controlled by an iRite program rather than by indicator data. The user program must provide the code necessary for widget manipulation.

11.2.1 Scale Widgets

Scale widgets are used to present basic scale data from one or more configured scales. For multiple scale applications, up to four scale widgets can be configured to be shown on the display at any one time. Fewer displayed widgets allow each widget to be larger. Scale data from additional configured scales can be shown by scrolling up or down through all configured scales, including a total scale widget, if configured.

```
WDGT#n=1, scale_widget_size, scales_displayed, screen_number
```

where:

```
n=widget number
1= scale widget type
scale_widget_size = 1-6 (size refers to numeral height)
1: 1/4"
2: 1/2"
3: 3/4"
4: 7/8"
5: 1"
6: 1 5/32"
scales_displayed = 1-4
screen_number = 1-10
```

Example:

```
WDGT#1=1,2,1,2<CR>
```

creates a single 1/2" scale widget for screen number 2.

11.2.2 Bitmap Widgets

Bitmap widgets provide a representation of vertical or horizontal tanks or a hopper. The location, size, and border style of the widget are specified on the WDGT command.

```
WDGT#n=2
```

```
left, top, width, height,border_style, bitmap_widget_style, name/alias, visible, screen_number
```

where:

```
n=widget number
2= bitmap widget type
left = left edge location, in pixels
top = top edge location, in pixels
width = width, in pixels
height = height, in pixels
border_style = 1 (none)
bitmap_widget_style = 1 (vertical tank), 2 (horizontal tank), 3 (hopper)
name/alias = text name or alias
```

visible = 1 (on) or 2 (off)

screen_number = 1-10

Example:

```
WDGT#2=2,30,30,120,120,1,3,Hopper1,1,2<CR>
```

creates a visible, 1.5" x 1.5" (120 x 120 pixel) hopper widget for screen 2, named Hopper1, with no border, with the upper left-hand corner of the bitmap at pixel location 30,30 (near upper left corner of display).

11.2.3 Bargraph Widgets

Bargraph widgets allow display of vertical or horizontal graphs, either a normal bargraph style or a needle gauge, with or without graduations. The graph can be used to represent scale weight or progress toward a setpoint target value.

WDGT#n=3, left, top, width, height, border_style, bargraph_widget_style, graduations, orientation, name/alias, data_source, data_field, data_subfield, visible, screen_number

where:

n=widget number

3= bargraph widget type

left = left edge location, in pixels

top = top edge location, in pixels

width = width, in pixels

height = height, in pixels

border_style = 1 (none) or 2 (fixed single)

bargraph_widget_style = 1 (basic), 2 (meter)

graduations = 1 (on), 2 (off)

orientation = 1 (horizontal), 2 (vertical)

name/alias = text name or alias

data_source = 1 (scale), 2 (program), 3 (setpoint)

data_field

If data_source = 1, data_field is the scale channel number

If data_source = 3, data_field is the setpoint number, 1–100, or 0 (current setpoint)

data_subfield

If data_source = 1, data_subfield is 1 (gross), 2 (net), 3 (displayed value)

If data_source = 3 and bargraph_widget_style is 2, data_subfield is the current value of the setpoint.

visible = 1 (on) or 2 (off)

screen_number = 1–10

Example:

```
WDGT#2=3,30,30,30,100,2,1,1,2,,Graph1,1,1,1,1,2<CR>
```

*creates a visible, 30 x 100 pixel bargraph widget for screen 2, named **Graph1**, with a single border, with the upper left-hand corner of the bargraph at pixel location 30,30 (near upper left corner of display). The bargraph is of the basic style (1), with graduations turned on (1) and is oriented vertically (2). Bargraph source is the gross weight from scale channel 1.*

11.2.4 Label Widgets

Label widgets are used to insert a text label in the display.

WDGT#n=4, left, top, width, caption, border_style, justification, font_size, name/alias, data_source, data_field, data_subfield, visible, screen_number

where:

n=widget number

4= label widget type

left = left edge location, in pixels

top = top edge location, in pixels

width = width, in pixels

caption = text caption

border_style = 1 (none) or 2 (fixed single)

justification = 1 (left), 2 (right), 3 (center)

font_size = 1 (9 pt), 2 (12 pt), 3 (18 pt)

name/alias = text name or alias

data_source = 1 (scale), 2 (program), 3 (setpoint), 4 (caption text)

data_field

If data_source = 1, data_field is the scale channel number

If data_source = 3, data_field is the setpoint number, 1–100, or 0 (current setpoint)

data_subfield

If data_source = 1, data_subfield is the scale alias (text

If data_source = 3, data_subfield is the setpoint name

visible = 1 (on) or 2 (off)

screen_number = 1–10

Example:

`WDGT#2=4,60,60,120,Caption, 2,1,1,Label1,4,0,0,1,2<CR>`

creates a visible, 30 x 100 pixel label widget for screen 2, named Label1, with a single border, with the upper left-hand corner of the label at pixel location 60,60. The label is left-justified (1), with text in a 9-pt font (1). Label source is the text specified for the caption (4)—the word "Caption".

11.2.5 Numeric Widgets

Numeric widgets are used to provide numeric information in the display.

WDGT#n=5, left, top, width, border_style, justification, font_size, name/alias, data_source, data_field, data_subfield, visible, screen_number

where:

n=widget number

5= numeric widget type

left = left edge location, in pixels

top = top edge location, in pixels

width = width, in pixels

border_style = 1 (none) or 2 (fixed single)

justification = 1 (left), 2 (right), 3 (center)

font_size = 1 (9 pt), 2 (12 pt), 3 (18 pt)

name/alias = text name or alias

data_source = 1 (scale), 2 (program), 3 (setpoint)

data_field

If data_source = 1, data_field is the scale channel number

If data_source = 3, data_field is the setpoint number, 1–100, or 0 (current setpoint)

data_subfield

If data_source = 1, data_subfield can be:

1 (gross, primary units)

2 (gross, secondary units)

3 (gross, tertiary units)

4 (net, primary units)

5 (net, secondary units)

6 (net, tertiary units)

7 (displayed value)

8 (rate of change value);

If data_source = 3, data_subfield can be:

1 (setpoint value)

2 (preact value)

3 (tolerance band value)

visible = 1 (on) or 2 (off)

screen_number = 1–10

Example:

`WDGT#2=5,60,60,120, 2,1,1,Numeric1,1,1,7,1,2<CR>`

creates a visible, 120-pixel wide, numeric widget for screen 2, named Numeric1, with the upper left-hand corner of the label at pixel location 60,60. The label is left-justified (1), with text in a 9-pt font (1). The widget shows the displayed weight (data_subfield = 7) from scale channel 1 (data_source = 1, data field = 1).

11.2.6 Symbol Widgets

Symbol widgets provide icons to indicate a variety of alarms, conditions, or device states.

WDGT#n=6, left, top, symbol_style, name/alias, data_source, data_field, data_subfield, visible, screen_number
where:

n=widget number

6= symbol widget type

left = left edge location, in pixels

top = top edge location, in pixels

symbol_style = 1–41 ([Table 11-22 on page 122](#))

name/alias = text name or alias

data_source = 1 (scale), 2 (program), 3 (setpoint), 4 (digital I/O point)

data_field

If data_source = 1, data_field is the scale channel number

If data_source = 3, data_field is the setpoint number, 1–100, or 0 (current setpoint)

If data_source = 4, data_field is 0 (onboard I/O, bits 1–4) or the I/O expansion card number, 1–14

data_subfield

If data_source = 1, data_subfield can be:

1 (tare)

2 (motion)

3 (center of zero)

4 (overload)

5 (underload)

If data_source = 3, data_subfield can be:

1 (setpoint state)

2 (tolerance check)

If data_source = 4, data_subfield specifies the bit number of the onboard or expansion card digital I/O channel: 1–4 (for onboard I/O, data_field=0) or 1–24 (for expansion card I/O)

visible = 1 (on) or 2 (off)

screen_number = 1–10

Example:

```
WDGT#2=6,120,120,6,Alarm, 4,12,1,1,2<CR>
```

creates a visible symbol widget for screen 2, named Alarm, using the bell symbol (widget number 6 in [Table 11-22 on page 122](#)), with the upper left-hand corner of the label at pixel location 120,120. The symbol toggles on or off depending on the state of bit 1 on digital I/O expansion card 12.



NOTE: For symbol widgets associated with setpoint digital outputs, the widget is set to state 1 when the setpoint is tripped, but the state of the digital output depends on the type of setpoint ([Table 11-22 on page 122](#)).

Batch setpoints: When tripped, the associated digital output is set **inactive** (widget set to state 1).

Continuous setpoints: When tripped, the associated digital output is set **active** (widget set to state 1).

Symbol Style (x)	Descriptions	Widget State (y)					
		y = 1		y = 2		y = 3	
1	Tare	Tare		Off	[Blank]	P. Tare	
2	Standstill	On		Off	[Blank]	--	--
3	COZ	On		Off	[Blank]	--	--
4	Round	Empty		Full		--	--
5	Square	Empty		Full		--	--
6	Bell	On		Off	[Blank]	--	--
7	Exclamation Mark	On		Off	[Blank]	--	--
8	Light Bulb	On		On/Bright		Off	[Blank]
9	Reject	On		Off	[Blank]	--	--
10	Over/Under	=		-		+	
11	Stop Light	Green		Red		Yellow	
12	Left	On		Off	[Blank]	--	--
13	Right	On		Off	[Blank]	--	--
14	Up	On		Off	[Blank]	--	--
15	Down	On		Off	[Blank]	--	--
16	Speaker	Quiet		Loud		Off	[Blank]
17	Serial	Connect		Disconnect		Off	[Blank]
18	Truck 1	On		Off	[Blank]	--	--
19	Truck 2	On		Off	[Blank]	--	--
20	Weight	On		Off	[Blank]	--	--
21	Overload	On		Off	[Blank]	--	--
22	Underload	On		Off	[Blank]	--	--
23	Stop	On/Dark		Off	[Blank]	On/Light	
24	Yield	On		Off	[Blank]	--	--
25	Skull & Crossbones	On		Off	[Blank]	--	--
26	Unbalance	On		Off	[Blank]	--	--
27	Runner	Slow		Fast		Off	[Blank]

Table 11-22. Symbol Widgets























Symbol Style (x)	Descriptions	Widget State (y)					
		y = 1		y = 2		y = 3	
28	Walker	Left leg		Right leg		Off	[Blank]
29	Printer	On		Off	[Blank]	--	--
30	Hourglass	On		Off	[Blank]	--	--
31	Gas Pump	On		Off	[Blank]	--	--
32	Conveyor	Empty		Full		Off	[Blank]
33	Batch	Automatic		Manual		Off	[Blank]
34	Valve	Closed		Open		Off	[Blank]
35	Motor	Stop		Run		Off	[Blank]
36	Checkmark	On		Off	[Blank]	--	--
37	Faucet	Closed		Open		Off	[Blank]
38	Padlock	Locked		Open		Off	[Blank]
39	Key	On		Off	[Blank]	--	--
40	Pipe	Empty		Full		Off	[Blank]
41	Not	On		Off	[Blank]	--	--

Table 11-22. Symbol Widgets (Continued)

12.0 Maintenance/Troubleshooting

12.1 Troubleshooting

Table 12-1 lists general troubleshooting tips for various hardware and software error conditions. See the following pages for additional information about specific diagnostic tools. Additionally, the CPU board has diagnostic LEDs that flash when sending/receiving data, and a heartbeat LED for troubleshooting.

Symptom	Cause/Remedy
Indicator does not power up	Possible blown fuse or bad power supply; check all voltages on CPU board; Power supply should output both +6 V and –6 V levels to the CPU board; If power supply is bad, check the small glass fuse, 2.5 A, 5x20 mm (PN 85791) or 4 A, 5x20 mm, on the power supply board
Front panel power indicator blinking ()	Power supply overloaded; Check for shorts in A/D card regulators or in the DC-to-DC converter of any installed analog output or pulse input cards
Blue screen	Check LCD contrast pot (under interface board access cover); Possible corrupt core software; Reset or reload software
A critical configuration error has been detected	Indication of a bad battery; Press Enter to retrieve the last Save and Exit contents
Hangs in 888 display	Corrupt core software; Reset or reload software
Tare and truck data pointers are corrupt, Tare storage is corrupt error messages at startup	Possible dead battery; Perform configuration reset then check for low battery warning on display; If battery is low, replace battery, perform another configuration reset, then reload files
Divide by zero error message at startup	User program error (Section 12.1.3 on page 126)
ERROR message in weight display	Excitation voltage too low or off; Excitation voltage is provided by the A/D card
Dashes in weight display	Over-range or under-range scale condition; Check scale for out-of-range conditions in total scale display, check all scale inputs for positive weight values
Display reads 0.000000	Scale not updating; Check for bad option card hanging the bus
Cannot enter setup mode	Possible bad switch; Test switch; Replace interface board if necessary
Serial port not responding	Possible configuration error; For command input, ensure port INPUT parameter is set to CMD
A/D scale out of range	Check source scale for proper mechanical operation; Check load cell and cable connection; Possible bad load cell: check indicator operation with load cell simulator
Locked — Scale in use	Scale is assigned as an input to a total scale or is the source for a serial scale, analog output or setpoint; If not correct, un-configure this scale assignment and reconfigure as required
Serial scale out of range	Check source scale for proper mechanical operation; Check cable connection; possible format mismatch between serial scale and 920i: check SFMT specification under SERIAL menu
Option x Error	Field bus card (PROFIBUS, DeviceNet, or Remote I/O) in slot x failed to initialize
Option card failure	Possible defective card or slot; Disconnect power, install card in different slot, then apply power again
Option card hardware diagnostic error	Required option card not found (Section 12.1.1 on page 125)
Expansion board does not power up	Check expansion board power supply
Download error during PLOAD command	Insufficient memory for PLOAD mapping due to older CPU board; Large programs may require Rev E or later 920i CPU board

Table 12-1. Basic Troubleshooting

12.1.1 Option Card Diagnostic Errors

Option cards are detected by the 920i at power-up. If the current indicator configuration requires an option card but that card is not detected at power-up, an error similar to the following is displayed:

```
HARDWARE CRITICAL TO PROPER OPERATION
WITH CURRENT CONFIGURATION
CANNOT BE FOUND
```

```
A/D SLOT 4 CHANNEL 1
```

```
INSTALL HARDWARE OR RECONFIGURE
```

To recover from this error, do the following:

- If the option is required, ensure that the card is properly seated in its slot and cycle the power; If the card is still not recognized, replace the card or try installing the card in a different slot
- Enter setup mode and reconfigure to eliminate the requirement for the option
- Go to the VERSION menu and use the **Reset Config** softkey (or RESETCONFIGURATION command) to perform a configuration reset; Configuration reset returns all configuration values to their factory defaults

See [Section 12.1.2](#) below, for information about using the HARDWARE serial command to verify that installed cards are recognized.

12.1.2 Using the HARDWARE Command

The HARDWARE serial command can be issued to verify that all installed cards are recognized by the system. The HARDWARE command returns a string of card type codes, representing cards installed in slots 1–14:

```
HARDWARE=3,3,2,4,5,0,0,0,0,0,0,0,0
```

[Table 12-2](#) lists the card codes returned by the HARDWARE command.

Code	Card Type
0	No card installed
1	Dual-Channel Serial Expansion Card
2	Dual-Channel A/D Card
3	Single-Channel A/D Card
4	Single-Channel Analog Output Card
5	24-Channel Digital I/O Expansion Card
6	Pulse Input Card
7	1 MB Memory Expansion Card
9	DeviceNet Card
10	Profibus Card
11	EtherNet/IP Card
12	Remote I/O Card
14	Custom Card
15	Analog Input Card
16	Generic Anybus Card (ControlNet or ProfiNet)
17	Dual-Channel Analog Output Card
18	EtherCat Card

Table 12-2. HARDWARE Command Option Card Codes



NOTE: Code 11 is returned only by the EtherNet/IP card. The standard 10M/100Mbps Ethernet card does not return a card type code. Any slot containing a standard Ethernet card will return a value of 0 on the HARDWARE command.

If an installed card is not recognized (HARDWARE command returns a code of 0 for that slot), ensure that the card is seated properly. Reinstall the card, if necessary, then cycle the indicator power to read the configuration again. If the card is still not recognized, try installing it in another slot.

12.1.3 User Program Diagnostic Errors

Faulty user programs can cause critical errors that are detected by the 920i at power-up. The following error message is caused by a user program attempting to divide by zero:

A CRITICAL USER PROGRAM ERROR
HAS BEEN DETECTED

DIVIDE BY ZERO

SYSTEM RESET IS REQUIRED

To recover from this error, do the following:

- Cycle the indicator power to reset the user program
- Correct the iRite program to eliminate the divide by zero operation; Recompile the program, then download the corrected program to the indicator

If technical assistance is required, contact Rice Lake Weighing Systems technical support.



NOTE: All A/D scales need to be loaded with a 350 ohm resistor for the iRite start up handler to run.

Diagnostic Boot Procedure

If a user program causes an error in the start-up handler, press and hold the setup switch while cycling power to the 920i to place the indicator in setup mode. Use iRev 4 monitor mode to send the PCLR command erase clear the user program.

If the error is still not cleared, perform the following diagnostic boot procedure.

1. Disconnect power to the 920i.
2. Connect the serial port of a PC with iRev 4 installed to port 2 of the 920i. Connection must be made at 38400 bps.

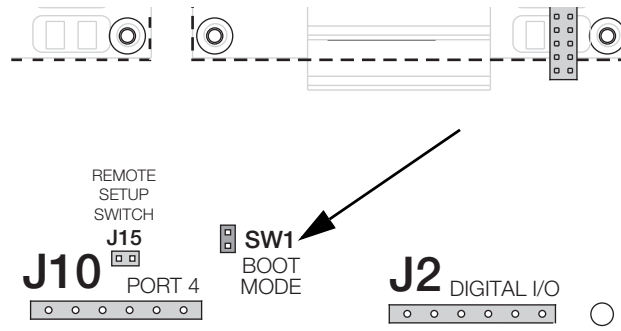

Figure 12-1. SW1 Boot Mode Pins

3. Open the indicator enclosure and place a jumper across the **SW1** boot mode pins.
4. Power up the 920i. The indicator will stall at the diagnostic monitor.
5. Start iRev 4 and enter monitor mode, then type **BOOT**.
6. Use the indicator setup switch to enter setup mode.
7. Remove the jumper from **SW1**.
8. From monitor mode, enter the **RESETCONFIGURATION** command.

Determine the cause of the startup handler error, make program corrections, then reload the corrected user program and test.

12.1.4 Using the XE Serial Command

The XE serial command can be used to remotely query the 920i for the error conditions shown on the front panel. The XE command returns a decimal number representing any existing error conditions. For multi-scale applications, the value returned by the XE command represents all error conditions, if any, present on all configured scales.

If more than one error condition exists, the number returned is the sum of the values representing the error conditions, see [Table 12-3](#).

Example: if both a tare error (TAREERR, 65536) and a truck database checksum error (ETRUCKERR, 8192) have occurred, the XE command returns the value 73728, representing the sum of those two error conditions.

Error Code	Value	Descriptions
VIRGERR	1	Virgin error
PARMCHKERR	2	Configuration checksum error
LOADCHKERR	4	Calibration checksum error
PRINTCHKERR	8	Print format checksum error
ENVRAMERR	16	General NVRAM error
ENVCRC1ERR	32	Setpoint NVRAM data error
ENVCRC2ERR	64	
ENVCRC3ERR	128	
ENVCRC4ERR	256	
ENVCRC5ERR	512	
ENVCRC6ERR	1024	
ENVCRC7ERR	2048	
ENVCRC8ERR	4096	
ENVCRC9ERR	8192	Audit trail error
ETRUCKERR	16384	Truck database checksum error
GRAVERR	32768	Gravity calibration error
—	65536	Reserved
TAREERR	131072	Tare checksum error
EACCOVER	262144	Accumulator overflow error
STRINGERR	524288	String program error
—	1048576	Reserved
RTCERR	2097152	Real time clock error

Table 12-3. Error Codes Returned on XE Command

13.0 Appendix

13.1 Total Scale Configuration

The output of two or more A/D scales or iQUBE² systems can be configured to function as a total scale. Once configured and calibrated, the total scale can be used as a source for other system functions, including streaming, setpoints, print formatting, and analog output.

To set up a total scale from the indicator front panel, use the scale configuration display to select the A/D scales or iQUBE² systems to configure as a total scale (use the **Change Type** softkey to show available A/D scales or iQUBE² systems; use the right navigation key to select the total scale sources). In iRev 4, assign the total scale to an unused position then select source scales from the existing A/D scales or iQUBE² systems. The Total Scale number must be a higher scale number than the Source Scale numbers.

Example: Scale 1 (Source Scale) + Scale 2 (Source Scale) = Scale 3 (Total Scale)















The **FORMAT** configuration of the total scale should match that of the source scales (Figure 4.7 on page 39). However, the value specified for the total scale **GRADS** parameter should be specified as the sum of the **GRADS** values for the source scales. For example: if **SCALE 1** is set to **GRADS=10000**, **SCALE 2** to **GRADS=5000**, **SCALE 3** (the total scale) should be set to 15000 grads.









The total scale shows an over-range indication if the maximum capacity of any source scale is exceeded, and show dashes if any source scale reads a negative value. The zero operation applies to both Source and Total Scales but a zero operation on all scales only works if all scales can be zeroed. If any scales are in motion or out of zero range, the zero operation will fail. Source scales are always left in gross mode. The tare operation only applied to the total scale, which will display gross or net weights.

13.2 Serial Scale Interface

Serial ports 3 through 32 can be configured for serial scale input. The serial scale function allows other scale indicators to send gross, net, or tare weight data to the 920i. Once a serial port has been configured to accept scale data, the data format can be customized to match the data stream sent by that indicator.

To configure a serial scale, do the following:

1. Place the indicator in setup mode (Section 4.3 on page 27). The main menu displays.
2. Press  or  to highlight **SERIAL**.
3. Press . The ports are displayed.
4. Press  or  to highlight desired port.
5. Press . The port types are displayed.
6. Press  or  to select SCALE (Legal for Trade serial scale) or IND SC (industrial serial scale).
7. Press  to return to **SERIAL** and  to highlight **SCALES**.
8. Press  and  or  to select **CONFIG**.
9. Press  to select the serial port to set.
 - If the serial scale is not shown, press the **Change Type** softkey to select available serial scales
 - Press  to select the serial scale
 - Press the **Add** softkey to move the scale to the right-hand column
 - Press the **Done** softkey

10. Press  to return to **SCALES** and  to highlight **SERIAL**.
11. Press  and  or  to the selected port.
12. Press  twice to enter the menu parameters.
13. Press  or  to highlight **SFMT**.
14. Press  to edit the string format.

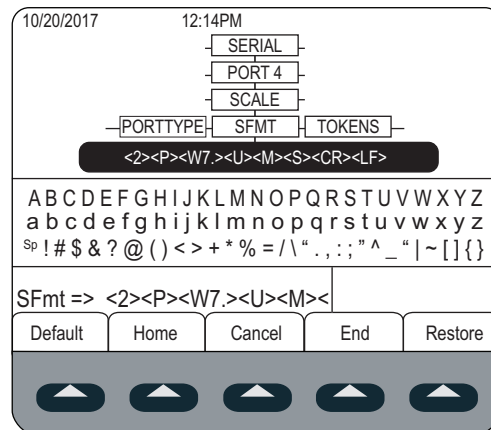

Figure 13-1. Serial Scale – SFMT

The default serial scale format is:

`<2><P><W7.><U><M><S><CR><LF>`

where:

- `<2>` STX character
- `<P>` Polarity
- `<W7.>` Seven characters of net data with decimal point
- `<M>` Mode
- `<U>` Units
- `<S>` Status
- `<CR>` Carriage return
- `<LF>` Line feed

Industrial serial scales (INDUST) do not require the `<M>`, `<U>`, and `<S>` identifiers. However, the units and number of decimal places must be specified. Units can be selected from the FORMAT menu; decimal places should be indicated on the w-spec identifier. For example, a seven-digit weight requiring two decimal places should be specified as `<W7.2>` rather than `<W7.>`.

See [Section 4.7.8 on page 44](#) for more information about stream formatting and format identifiers.

iRev 4 provides several preset scale formats within its Stream Formatting function. See [Section 6.0 on page 62](#) for iRev information.

13.3 Stream Formatting Examples

13.3.1 Toledo 8142 Indicator

Sample string for Toledo 8142 indicator (with no checksum):

<STX><Status Word A><Status Word B><Status Word C><wwwwww><ttttt><EOL>

String recognized by the 920i:

<02><B2, B0, B1, B13, B17><B2, B0, B1, B8, B5, B7, B6, B3><B2, B0, B1, B0, B0, B0, B0, B0><W06><T06><CR>

Identifier	920i Stream Format
<STX>	The STX character is entered into the string using the <02> hex value
<Status Word A>	Toledo status words are made up of various bit fields which are replaced by the 920i format identifiers (Table 4-14 on page 44) NOTE: Identifiers must be entered beginning with the high-order bit (bit 7-bit0) of the Toledo status word. Status Word A contains the following fields; equivalent 920i format identifiers are shown in parentheses Bit 7: parity (920i bit field B2) Bit 6: always 0 (B0) Bit 5: always 1 (B1) Bits 3–4: display divisions (B13) Bits 0–2: decimal format (B17)
<Status Word B>	Status Word B contains the following fields; equivalent 920i format identifiers are shown in parentheses Bit 7: parity (920i bit field B2) Bit 6: always 0 (B0) Bit 5: always 1 (B1) Bit 4: lb/kg units (B8) Bit 3: stable/motion (B5) Bit 2: in/out-of-range (B7) Bit 1: pos/neg (B6) Bit 0: gross/net (B3)
<Status Word C>	Status Word C contains the following fields; equivalent 920i format identifiers are shown in parentheses Bit 7: parity (920i bit field B2) Bit 6: always 0 (B0) Bit 5: always 1 (B1) Bits 0–4: always 0 (B0)
<wwwwww>	The <W06> and <T06> indicate six digits of indicated weight and tare weight with leading zeros; valid characters are W, w, G, g, T, t, N, or n (lower case indicates left justified); W indicates current weight, G–gross weight, N–net weight, T–tare weight. /P, /S, and /T can be used to specify primary, secondary, or tertiary units; Minus (-) indicates sign inclusion; (0) indicates leading zeros; first digit indicates field width in characters; a decimal point (.) indicates floating decimal point; a decimal with subsequent digit indicates fixed decimal with n digits to the right of the decimal two consecutive decimals (for example, <W06.>) send the decimal point even if it falls at the end of the transmitted weight field
<ttttt>	Tare weight; see description above
<EOL>	<CR> is entered at the end of the string as the end of line character in this example

Table 13-1. Toledo Sample String Identifiers

13.3.2 Cardinal 738 Indicator

Sample string for the Cardinal 738 indicator:

```
<CR><POL><wwwwww><S><SP><units><SP><G/N><SP><SP><EOL>
```

String recognized by the 920i:

```
<CR><P><W06.><S><SP><U><SP><M><SP2><03>
```

Identifier	920i Stream Format
<CR>	Carriage Return
<POL>	Cardinal uses + for positive and – For negative, so the stream polarity tokens need to reflect this; The serial commands for the 920i are STR.POS#p=+ and STR.NEG#p=–
<wwwwww>	The <W06.> identifier that the 920i recognizes indicates six digits of weight with a decimal and leading zeros, with the decimal sent at the end of the weight; Valid characters are W, w, G, g, T, t, N, or n (lower case indicates left justified); W indicates current weight, G–gross weight, N–net weight, T–tare weight. /P, /S, and /T can be used to specify primary, secondary, or tertiary units; Minus (–) indicates sign inclusion; (0) indicates leading zeros; first digit indicates field width in characters; A decimal point (.) indicates floating decimal point; A decimal with subsequent digit indicates fixed decimal with n digits to the right of the decimal; Two consecutive decimals (for example, <W06.>) send the decimal point even if it falls at the end of the transmitted weight field
<S>	There are four possible tokens for status bits that can be used: motion, out-of-range, valid, and invalid; In the Cardinal, m indicates motion, o indicates out-of-range; a space is used for valid or invalid weights; The commands to set these tokens in the 920i are STR.MOTION#p=m, STR.RANGE#p=o, STR.OK#p= , STR.INVALID#p= . NOTE: A space must be entered following the equals sign on the OK and INVALID serial commands
<SP>	Space
<units>	The Cardinal uses two-character, lower-case units identifiers; The commands to set these tokens in the 920i include: STR.PRI#p=lb (options: kg, g, tn, t, gr, oz, or sp), STR.SEC#p=kg and STR.TER#p=kg (options: lb, g, tn, t, gr, oz, or sp)
<SP>	Space
<g/n>	The mode used for Cardinal is g for gross and n for net; These tokens are set using the STR.GROSS#p=g and STR.NET#p=n tokens
<SP>	Space
<SP>	Space
<EOL>	The end of line character is an ETX in this example so the hex value of <03> is entered in the string

Table 13-2. Cardinal Sample String Identifiers

13.3.3 Weightronix WI -120 Indicator

Sample string for the Weightronix WI-120 indicator:

```
<SP><G/N><POL><wwwwww><SP><units><EOL>
```

String recognized by the 920i:

```
<SP><M><P><W06.><SP><U><CR><LF>
```

Identifier	920i Stream Format
<SP>	Space
<G/N>	The mode used for Weightronix is G for gross and N for net; These tokens are set using the STR.GROSS#p=G and STR.NET#p=N tokens
<POL>	Since the Weightronix uses + for positive and – For negative, the polarity tokens need to reflect this; the serial commands for the 920i are STR.POS#p=+ and STR.NEG#p=– .
<wwwwww>	The <W06.> that the 920i recognizes indicates six digits of weight with a decimal and leading zeros; Valid characters are W, w, G, g, T, t, N, or n (lower case indicates left justified); W indicates current weight, G–gross weight, N–net weight, T–tare weight. /P, /S, and /T can be used to specify primary, secondary or tertiary units; Minus (–) indicates sign inclusion; (0) indicates leading zeros; first digit indicates field width in characters; A decimal point (.) indicates floating decimal point; A decimal with subsequent digit indicates fixed decimal with n digits to the right of the decimal; Two consecutive decimals (for example, <W06.>) send the decimal point even if it falls at the end of the transmitted weight field
<SP>	Space
<units>	The Weightronix uses two-character, lower-case units identifiers; The commands to set these tokens in the 920i include: STR.PRI#p=lb (options: kg, g, tn, t, gr, oz, or sp), STR.SEC#p=kg (options: lb, g, tn, t, gr, oz, or sp)
<EOL>	<CR> or <CR> and <LF>

Table 13-3. Weightronix Sample String Identifiers

13.4 Data Formats

Continuous Output Serial Data Format

If continuous transmission is configured for a serial port (STREAM parameter set to LFT or INDUST on the SERIAL menu), the 920i sends data using the Consolidated Controls serial data format shown in [Figure 13-2](#):

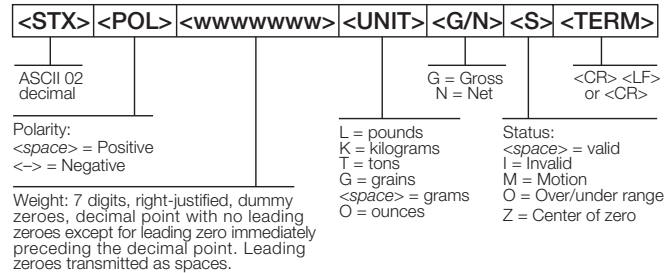

Figure 13-2. Continuous Output Serial Data Format

Demand Output Serial Data Format

When demand mode is configured for the serial port (STREAM parameter set to OFF), the 920i uses a data string formatted for a basic ticket printout. The particular ticket format printed depends on the indicator configuration.

To customize the ticket to work with a wide variety of printers, scoreboard displays, and other remote equipment. See [Section 8.0 on page 75](#) for more information on custom print formats.

RS-485 Data Formats

Two-wire RS-485 communications is available on port 4 of the CPU board; four-wire RS-485 communications is supported on the A ports of any installed serial expansion cards.

The 920i has a built-in RS-485 software protocol which is enabled when assigned a non-zero address to the indicator. Valid RS-485 addresses must be in the range 1–255; the address is specified on the ADDRESS parameter on the SERIAL menu.

All remote commands are initiated using the data format shown in [Figure 13-3](#):

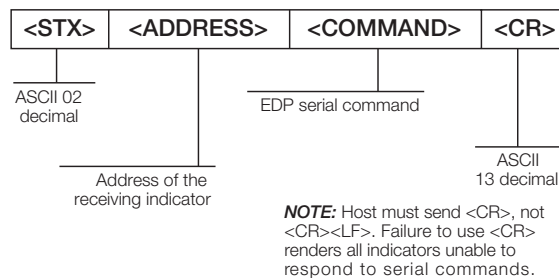

Figure 13-3. RS-485 Send Data Format

If the initiating device address matches the port address of an 920i on the RS-485 network, that indicator responds.

Example, with demand outputs, or in response to an XG#1 command, the responding indicator uses the format shown in [Figure 13-4](#):

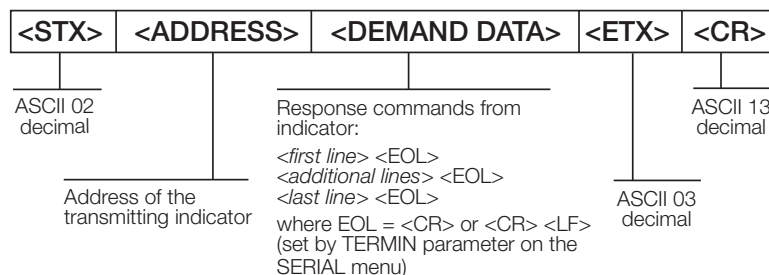

Figure 13-4. RS-485 Respond Data Format

Example: To send the XG#1 command from an ASCII terminal to an indicator at address 65 (decimal) on the RS-485 network, use the format shown in [Figure 13-3 on page 132](#).

- The keyboard equivalent for the start-of-text (STX) character is CONTROL-B
- The indicator address (65) is represented by an upper case **A**
- The carriage return (CR) character is generated by pressing the **Enter** key

To send the XG#1 command to the indicator at address 65, enter the following at the terminal: <CONTROL-B>AXG#1.

The indicator responds with the format shown in [Figure 13-4 on page 132](#):

```
<STX>A 1234.00 lb<CR><LF><ETX><CR>
```

13.5 Audit Trail Support

Audit trail support provides tracking information for configuration and calibration events. A separate calibration counter is provided for each scale; a single configuration counter tracks all configuration changes.

To prevent potential misuse, unsaved configuration or calibration changes are counted as change events; restoration of the previous saved configuration or calibration is also counted.

13.5.1 Displaying Audit Trail Information

To display audit trail information, press and hold the **Gross/Net** key for several seconds. Various audit trail information screens can then be accessed by pressing the front panel number keys (**1–7** and **0**). The exact format of each screen depends on the regulatory agency specified for the REGULAT (FEATURE menu) parameter.

The initial screen shown when entering the audit trail display (whenever the **1** key is pressed while showing audit trail information) shows the legally relevant (LR) version number (software version for the code that provides audit trail information), a calibration count and, if REGULAT=NTEP, a configuration count.

Press **2** to display the configuration count display. This display shows the number of times the system has been configured, the date and time of the last configuration event, and the before and after information for the most recent change of the system date and time.

Press the **Down** key to display number of weighments, number of configuration events, number of calibrations and the date and time of the most recent calibration for the first configured scale. Continue pressing the **Down** key to cycle through the information for all configured scales.

Press **3** to display the number and the most recent date and time of power-on events, power-on configuration changes and user program loads.

Use the **Down** key to display the number of power-on calibration events for all configured scales.

Press **4** to display number of times the OEM version number has changed, and the date and time of the most recent change.

Press **5** to display the number of times the configuration has been reset, the date and time of the most recent reset, and the indicator EIN number.

Press **6** to display the manufacturer of the indicator.

Press **7** to display the number of core loads, and the date and time of the most recent.

Press **0** to display the indicator and LR software versions.

When done, press the **Gross/Net** key to exit the audit trail displays.



13.5.2 Printing Audit Trail Information

Audit trail information can be printed by pressing the **PRINT** key while displaying the audit trail or by sending the DUMPAUDIT serial command. Audit trail information is sent to the port specified on the AUD.PORT serial command or by the AUDFMT parameter (PFORMT menu).



NOTE: Printed audit trail information contains data for all scales, whether configured or not, that can be supported by the indicator. Displayed audit trail information shows data only for currently configured scales.

14.0 Compliance

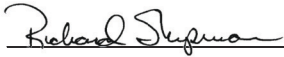
	EU DECLARATION OF CONFORMITY <i>EU-KONFORMITÄTSERKLÄRUNG</i> <i>DÉCLARATION UE DE CONFORMITÉ</i>		Rice Lake Weighing Systems 230 West Coleman Street Rice Lake, Wisconsin 54868 United States of America 
	Type/Typ/Type: 820i and 920i series		
English	We declare under our sole responsibility that the products to which this declaration refers to, is in conformity with the following standard(s) or other regulations document(s).		
Deutsch	Wir erklären unter unserer alleinigen Verantwortung, dass die Produkte auf die sich diese Erklärung bezieht, den folgenden Normen und Regulierungsbestimmungen entsprechen.		
Français	Nous déclarons sous notre responsabilité que les produits auxquels se rapporte la présente déclaration, sont conformes à la/aux norme/s suivante ou au/aux document/s normatif/s suivant/s.		
EU Directive	Certificates	Standards Used / Notified Body Involvement	
2014/30/EU EMC	-	EN 61326-1:2013, EN 55011:2009+A1:2010, EN 61000-6-1:1995, EN 61000-6-2:2007	
2014/35/EU LVD	-	IEC 60950-1 ed.2	
2011/65/EU RoHS	-	EN 50581:2012	
Signature:			Place: <u>Rice Lake, WI USA</u>
Type Name:	<u>Richard Shipman</u>		Date: <u>May 3, 2019</u>
Title:	<u>Quality Manager</u>		

UK CA

UK DECLARATION OF CONFORMITY

Rice Lake Weighing Systems
230 West Coleman Street
Rice Lake, Wisconsin 54868
United States of America

RICE LAKE
WEIGHING SYSTEMS

Type: 820i and 920i series

English We declare under our sole responsibility that the products to which this declaration refers to, is in conformity with the following standard(s) or other regulations document(s).

UK Regulations	Certificates	Standards Used / Approved Body Involvement
2016/1101 Low Voltage	-	IEC 60950-1 ed.2
2016/1091 EMC	-	EN 61326-1:2013, EN 55011:2009+A1:2010, EN 61000-6-1:1995, EN 61000-6-2:2007
2012/3032 RoHS	-	EN 50581:2012

Signature: Brandi Harder

Place: Rice Lake, WI USA

Name: Brandi Harder

Date: December 30, 2021

Title: Quality Manager

15.0 Specifications

Power

AC Voltages	100–240 VAC Frequency: 50–60 Hz
DC Voltages	12–24 VDC
Consumption	
AC	25 W, 65 W
DC	25 W

Excitation Voltage

10 ± VDC 8 x 350 Ω or 16 x 700 Ω load cells per A/D card

Analog Signal Input Range

-45 mV–45 mV

Analog Signal Sensitivity

0.3 μV/graduation minimum at 7.5 Hz
1.0 μV/graduation recommended

A/D Sample Rate

7.5–960 Hz, software selectable

Resolution

Internal	8 000 000
Display	9 999 999

System Linearity

±0.01% full scale

Digital I/O

Six I/O channels on CPU board
Optional 24-channel I/O expansion boards available

Communication Ports

Four ports on CPU board support up to 115,200bps

Port 1	Full duplex RS-232
Port 2	RS-232 with CTS/RTS; PS/2 keyboard interface via DB-9 connector
Port 3	Full duplex RS-232, 20 mA output
Port 4	Full duplex RS-232, 2-wire RS-485, 20 mA output

Optional dual-channel serial expansion boards available

Channel A	RS-232, RS-485, 20 mA
Channel B	RS-232, 20 mA

Display

4.6" x 3.4" (116 mm x 86 mm), 320 x 240 pixel LCD module with adjustable contrast

Transmissive display
Transflective display (optional)

Keys/Buttons

27-key membrane panel, tactile feel, PS/2 port for external keyboard connection

Temperature Range

Certified	14°–104° F (-10°–40° C)
Operating	14°–122° F (-10°–50° C)

Weight

Universal Enclosure	9.5 lb (4.3 kg)
Wall Mount Enclosure	23.0 lb (10.4 kg)
Panel Mount Enclosure	8.5 lb (3.9 kg)
Deep Universal	11 lb (5.0 kg)

Rating/Material

NEMA Type 4X/IP66, stainless steel

Warranty

Two-year limited warranty

EMC Immunity

EN 50082 Part 2 IEC EN 61000-4-2, 3, 4, 5, 6, 8, and 11

Approvals

NTEP



CoC Number 01-088

Accuracy Class III/IIIL n_{max} : 10 000

Measurement Canada

Approval AM-5426
Accuracy Class III n_{max} : 10 000

UL

Universal and Deep Universal



File Number: E151461

Panel Mount



File Number: E151461, Vol 2

Wall Mount



UL 508A control panel approved

File Number: E207758

OIML



GB-1140 n_{max} : 6 000

GB-1135 n_{max} : 10 000

The 920i complies with Part 15 of the FCC Rules.

Operation is subject to the following conditions:

- This device may not cause harmful interference.
- This device must accept any interference received, including interference that may cause undesired operation.

Radio certificate number:

- US: R68WIPORTG
- Canada: 3867A-WIPORTG



15.1 Dimension Drawings

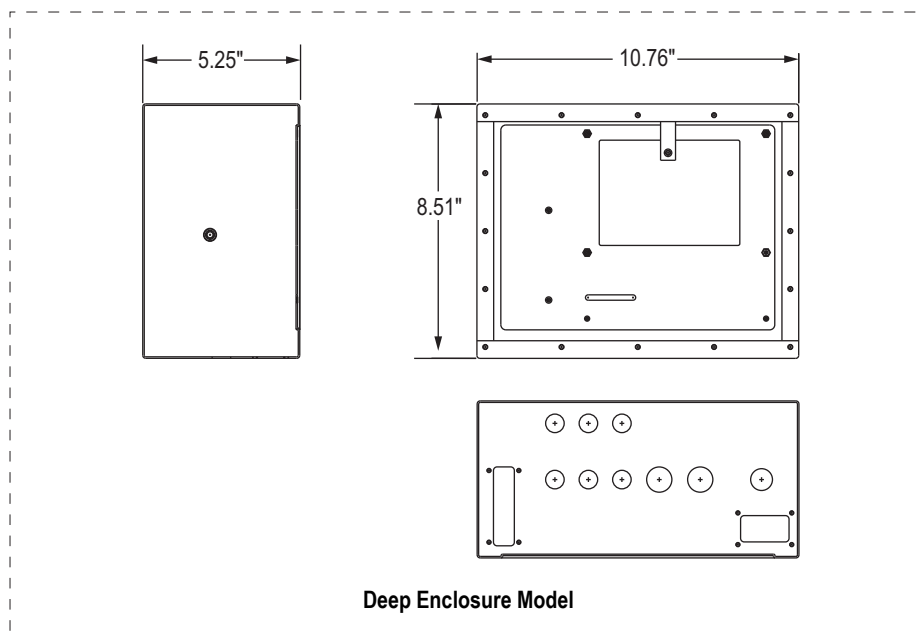
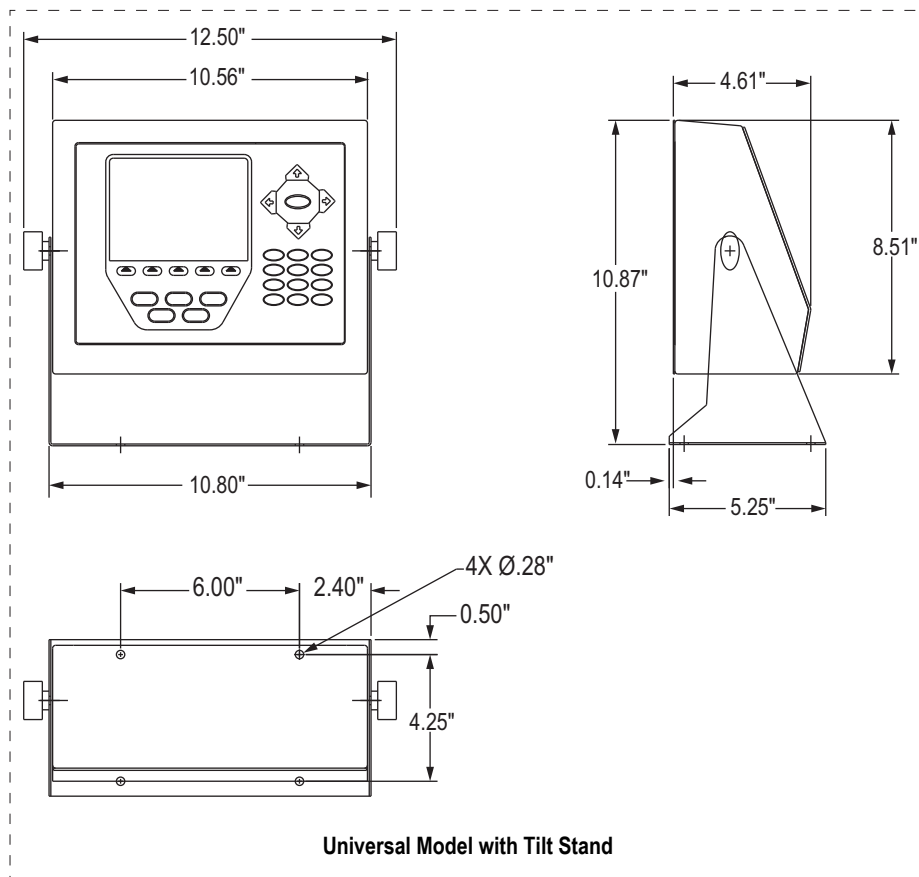

Figure 15-1. Universal and Deep Enclosure Models

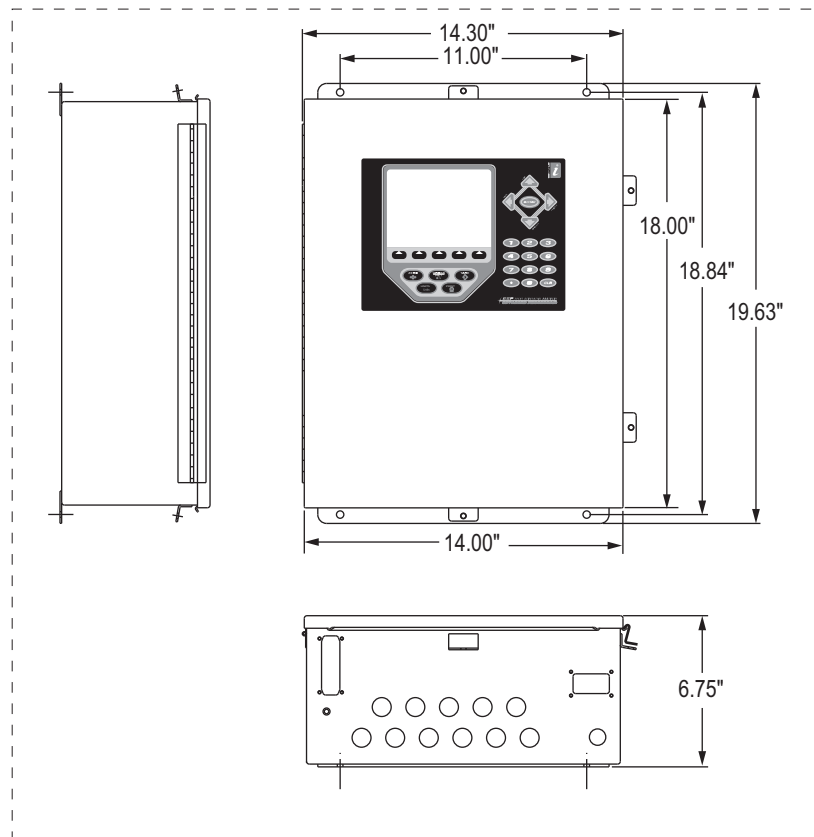
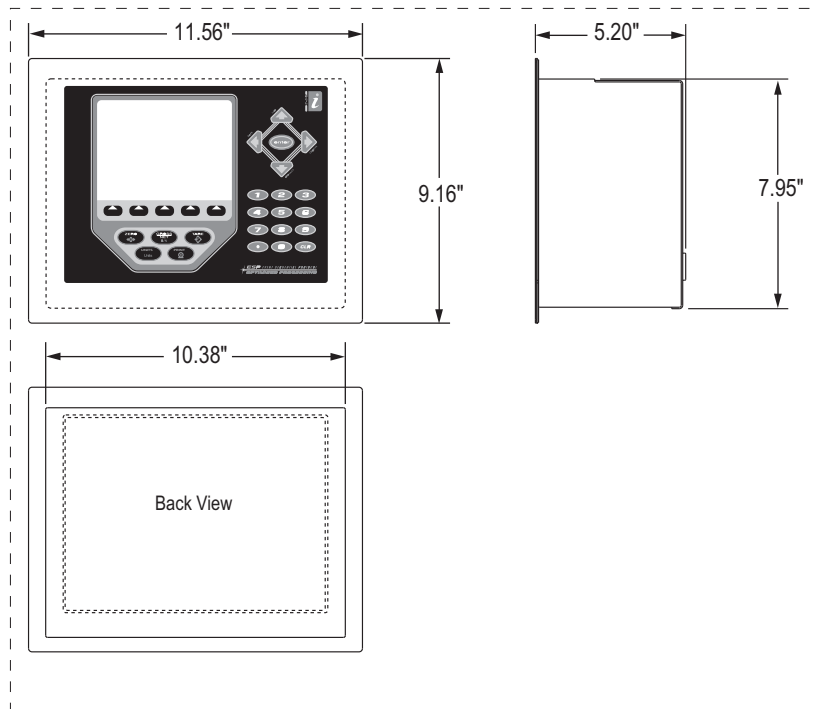

Figure 15-2. Panel Mount and Wall Mount Models

15.2 Printed Information

System Manuals

- 920i Installation Manual, PN 67887
- iRite™ Programming Reference, PN 67888

Enclosures

- 920i Panel Mount Installation Instructions, PN 69989
- 920i Wall Mount Installation Instructions, PN 69988
- 920i Deep Enclosure Installation Instructions, PN 83810

Expansion Boards

- Two-Card Expansion Board Installation Instructions, PN 71284
- Six-Card Expansion Board Installation Instructions, PN 71285

Option Cards

- 920i Analog Output Card Installation Instructions, PN 69089
- 920i Single-Channel A/D Card Installation Instructions, PN 69092
- 920i Dual-Channel A/D Card Installation Instructions, PN 69090
- 920i 24-Channel Digital I/O Expansion Card Installation Instructions, PN 69087
- 920i Dual-Channel Serial Expansion Card Installation Instructions, PN 69088
- 920i Pulse Input Card Installation Instructions, PN 69086
- 920i Memory Expansion Card Installation Instructions, PN 69085
- 920i Analog Input Card with Thermocouple Input Installation Instructions, PN 88110

Communications Options

- DeviceNet™ Interface Installation and Programming Manual, PN 69949
- Profibus® DP Interface Installation and Programming Manual, PN 69948
- Allen-Bradley® Remote I/O Interface Installation and Programming Manual, PN 69950
- Ethernet Communications Card Installation Instructions, PN 72117
- EtherNet/IP™ Interface Installation and Programming Manual, PN 88537
- ControlNet™ Interface Installation and Programming Manual, PN 103122

iQUBE² Digital Diagnostic Junction Box

- iQUBE² Installation Manual (PN 106113)

White Papers

- Using Ferrite Cores to Suppress Electromagnetic Interference - For Digital Weight Indicators, PN 117085



© Rice Lake Weighing Systems Specifications subject to change without notice.

230 W. Coleman St. • Rice Lake, WI 54868 • USA
U.S. 800-472-6703 • Canada/Mexico 800-321-6703 • International 715-234-9171 • Europe +31 (0)26 472 1319