

480 Legend Series

Digital Weight Indicator
Version 1.05

Technical Manual



REVOLUTION
SCALE SOFTWARE

RICE LAKE
WEIGHING SYSTEMS

© Rice Lake Weighing Systems. All rights reserved.

Rice Lake Weighing Systems® is a registered trademark of
Rice Lake Weighing Systems.

All other brand or product names within this publication are trademarks or
registered trademarks of their respective companies.

All information contained within this publication is, to the best of our knowledge, complete and
accurate at the time of publication. Rice Lake Weighing Systems reserves the right to make
changes to the technology, features, specifications and design of the equipment without notice.

The most current version of this publication, software, firmware and all other product
updates can be found on our website:

www.ricelake.com

Contents

1.0	Introduction	1
1.1	Safety	1
1.2	Overview	2
1.3	Operating Modes	2
1.4	Front Panel Keypad	3
1.5	Keypad Functions	3
1.6	LED Annunciators	4
1.7	Front Panel Navigation	5
1.7.1	Navigating Through Levels	5
1.7.2	Edit Parameter Values	5
1.7.3	Numeric Keypad - Editing Procedure for Numeric Values (480 Plus Only)	6
1.8	Indicator Operations	6
1.8.1	Menu	6
1.8.2	Zero Scale	6
1.8.3	Toggle Units	6
1.8.4	Acquire Tare	7
1.8.5	Preset Tare (Keyed Tare)	7
1.8.6	Display Tare	7
1.8.7	Print Ticket	7
1.8.8	Toggle Gross/Net Mode	7
1.8.9	View Audit Trail	8
1.8.10	Enter New Unit ID	8
1.8.11	Display Accumulator	8
1.8.12	Display or Change Time and Date	9
1.8.13	Display, Edit and Set Setpoint Value	9
1.8.14	View Firmware Version	9
1.8.15	Enter User Password	10
2.0	Installation	11
2.1	Unpacking	11
2.2	Enclosure Disassembly	11
2.3	Cable Connections	11
2.3.1	Cable Specifications	11
2.3.2	Cable Grounding	12
2.3.3	Stripping Cables	12
2.3.4	Load Cell Cables	13
2.3.5	Wiring	13
2.4	Battery Operation	15
2.4.1	Option Card Installation	16
2.5	Board Removal	16
2.6	Configurable Back Light	16
2.7	Enclosure Reassembly	17
2.7.1	Seal the Indicator (Optional)	18
2.8	Replacement Parts	19



Technical training seminars are available through Rice Lake Weighing Systems. Course descriptions and dates can be viewed at www.ricelake.com/training or obtained by calling 715-234-9171 and asking for the training department.

3.0	Configuration	22
3.1	User Menu Setup	24
3.1.1	Setpoint Menu	25
3.1.2	Serial Menu	27
3.1.3	Ethernet Menu	30
3.1.4	USB Menu	31
3.1.5	Print Format Menu	32
3.1.6	Version Menu	33
3.1.7	MISC Menu	33
3.2	Configuration Using the Front Panel (Legal for Trade)	34
3.2.1	Configuration Menu Structures and Parameter Descriptions	35
3.2.2	Adaptive Filter and Rolling Filter Sub-menu Parameters	37
3.2.3	Format Menu	38
3.2.4	Calibration Menu	39
3.2.5	Program Menu	40
3.2.6	Digital Input Menu	42
3.2.7	Analog Output Menu	43
3.2.8	Password Menu	44
3.2.9	USBMEM Menu	44
3.2.10	Test Menu	45
3.2.11	User Menu Setup	45
3.3	Revolution Configuration	45
4.0	Calibration	46
4.1	Front Panel Calibration	46
4.2	EDP Command Calibration	47
4.3	Revolution Calibration	48
4.4	More About Calibration	48
4.4.1	Adjusting Final Calibration	48
5.0	Revolution®	49
5.1	Connecting to the Indicator	49
5.2	Saving and Transferring Data	50
5.2.1	Saving Indicator Data to a Computer	50
5.2.2	Downloading Configuration Data from PC to Indicator	50
5.3	Reflash Indicator	50
5.3.1	480 Legend Series Flash Loader	50
5.3.2	480 Legend Series Firmware Update	50
6.0	EDP Commands	51
6.1	The EDP Command Set	51
6.1.1	Key Press Commands	52
6.1.2	Reporting Commands	52
6.1.3	The RESETCONFIGURATION Command	53
6.1.4	Parameter Setting Commands	53
6.1.5	Soft Reset	53
6.1.6	Normal Mode Commands	57
7.0	Print Formatting	58
7.1	Print Formatting Tokens	58
7.2	Customizing Print Formats	59
7.2.1	Using the Front Panel	59



Rice Lake continually offers web-based video training on a growing selection of product-related topics at no cost. Visit www.ricelake.com/webinars

8.0	Setpoints	60
8.1	Batch and Continuous Setpoints	60
9.0	Appendix	61
9.1	Error Messages	61
9.1.1	Displayed Error Messages	61
9.1.2	XE EDP Command	62
9.2	Status Messages	63
9.2.1	P EDP Command	63
9.2.2	ZZ EDP Command	63
9.3	Continuous Data (Stream) Output Formats	63
9.4	Local/Remote Operation	66
9.5	Audit Trail Support	66
9.6	Sleep Mode	66
9.6.1	Standby	67
9.7	Internal Battery Option	67
9.8	USB Option	67
9.8.1	HOST	67
9.8.2	Flash Drive	68
9.8.3	USB Printing	68
9.9	Ethernet Option	68
9.10	Conversion Factors for Secondary Units	69
9.11	Digital Filtering (DIGFIL)	69
9.11.1	Sample Rate (SMPRAT)	69
9.11.2	Adaptive Filter	69
9.11.3	Rolling Averaging Filter	70
9.12	Analog Output Calibration	71
9.13	Test Mode	71
9.14	Regulatory Mode Functions	72
9.15	ASCII Character Chart	73
9.16	Front Panel Display Characters	75
9.17	Compliance	76
9.18	Specifications	77



Technical training seminars are available through Rice Lake Weighing Systems. Course descriptions and dates can be viewed at www.ricelake.com/training or obtained by calling 715-234-9171 and asking for the training department.



Rice Lake continually offers web-based video training on a growing selection of product-related topics at no cost. Visit www.ricelake.com/webinars

1.0 Introduction

This manual is intended for use by service technicians responsible for installing and servicing 480 Legend Series digital weight indicators. This manual applies to indicators using Version 1.05 of the 480 Legend Series software.

Configuration and calibration of the indicator can be accomplished using the Revolution® configuration utility or the indicator front panel keys, See [Section 3.2 on page 34](#) for information about configuration methods.



Manuals and additional resources are available from Rice Lake Weighing Systems at www.ricelake.com/manuals

Warranty information is available at www.ricelake.com/warranties

1.1 Safety

Safety Signal Definitions:



DANGER Indicates an imminently hazardous situation that, if not avoided, will result in death or serious injury. Includes hazards that are exposed when guards are removed.



WARNING Indicates a potentially hazardous situation that, if not avoided, could result in serious injury or death. Includes hazards that are exposed when guards are removed.



CAUTION Indicates a potentially hazardous situation that, if not avoided, could result in minor or moderate injury.



IMPORTANT Indicates information about procedures that, if not observed, could result in damage to equipment or corruption to and loss of data.

General Safety



Do not operate or work on this equipment unless this manual has been read and all instructions are understood. Failure to follow the instructions or heed the warnings could result in injury or death. Contact any Rice Lake Weighing Systems dealer for replacement manuals.



Failure to heed could result in serious injury or death.

Some procedures described in this manual require work inside the indicator enclosure. These procedures are to be performed by qualified service personnel only.

Do not allow minors (children) or inexperienced persons to operate this unit.

Do not operate without the enclosure completely assembled.

Do not use for purposes other than weight taking.

Do not place fingers into slots or possible pinch points.

Do not use this product if any of the components are cracked.

Do not exceed the rated specification of the unit, See [Section 9.18 on page 77](#).

Do not make alterations or modifications to the unit.

Do not remove or obscure warning labels.

Do not submerge.

Before opening the unit, ensure the power cord is disconnected from the outlet.

1.2 Overview

The 480 is a single-channel digital weight indicator housed in a NEMA Type 4X/IP66-rated stainless steel enclosure. The indicator front panel consists of a large (.8 inch/20 mm), six-digit, seven-segment backlight LED display, with a seven-button keypad (480) or an 18-button full numeric keypad (480 Plus).

Features

- Auto switching AC power supply 115 VAC to 230 VAC, 50-60 Hz
- Drives up to ten 350 ohms or twenty 700 ohms load cells
- Supports four and six wire load cell connections
- Two communications ports with demand or continuous (COM 2 only) outputs
- Unit ID up to six numeric, operator entered.
- Accumulator with report and clear
- Time and date
- Audit trail tracking
- Configurable LED backlight
- Optional Ethernet/USB can connect to PC or printer in operation mode, or a flash drive to save or load configuration
- Optional analog output module provides 0–10/2–10 VDC or 0–20/4–20 mA tracking of gross or net weight values
- Optional digital I/O card, four outputs/two inputs for setpoints and key functions

Supported Applications

- Custom ticket Printing: gross, net & setpoint format can be customized up to 300 characters and print time and date, unit ID, and consecutive ticket number
- Basic Weighing: gross or net mode with operator menu to other functions
- Accumulation: weights are totaled, with armed print function
- Batching: up to eight batch steps with latched or continuous outputs for gross, net or delay setpoint; actions include trip high or low, wait for standstill, print, accumulate and tare
- Keyed Tare: preset tare value can be entered when the gross weight is at zero
- Local/Remote: remote unit displays weight and transmits key press commands to the local unit

1.3 Operating Modes

The 480 has four modes of operation.

Normal (Primary) Weigh Mode

Normal mode is the default mode of the indicator. The indicator displays gross or net weights as required, using the annunciators described in [Section 1.6 on page 4](#) to indicate scale status and the type of weight value displayed.

Configuration Mode

Most of the procedures described in this manual, including calibration, require the indicator to be in configuration mode.

To enter configuration mode:

1. Remove the setup switch access screw from the back of the enclosure, See [Figure 2-1 on page 11](#).
2. Insert a non-conductive tool into the access hole and press the configuration switch. Indicator displays **CONFIG**.

User Menu Setup Mode

The user menu setup mode is used to access the accumulator functions, audit trail, display the tare, unit ID, Time & date, setpoints, data communications parameters, print formats, and view the firmware version.

It is accessible by pressing the **Menu** key on the front panel.

See [Section 3.1 on page 24](#) for more information about the user setup mode.

Test Mode

Test mode provides a number of diagnostic functions for the 480 indicator, See [Section 9.13 on page 71](#) for more information about entering and using test mode.

1.4 Front Panel Keypad

See [Section 1.7 on page 5](#) for information about using the front panel keys in configuration mode.

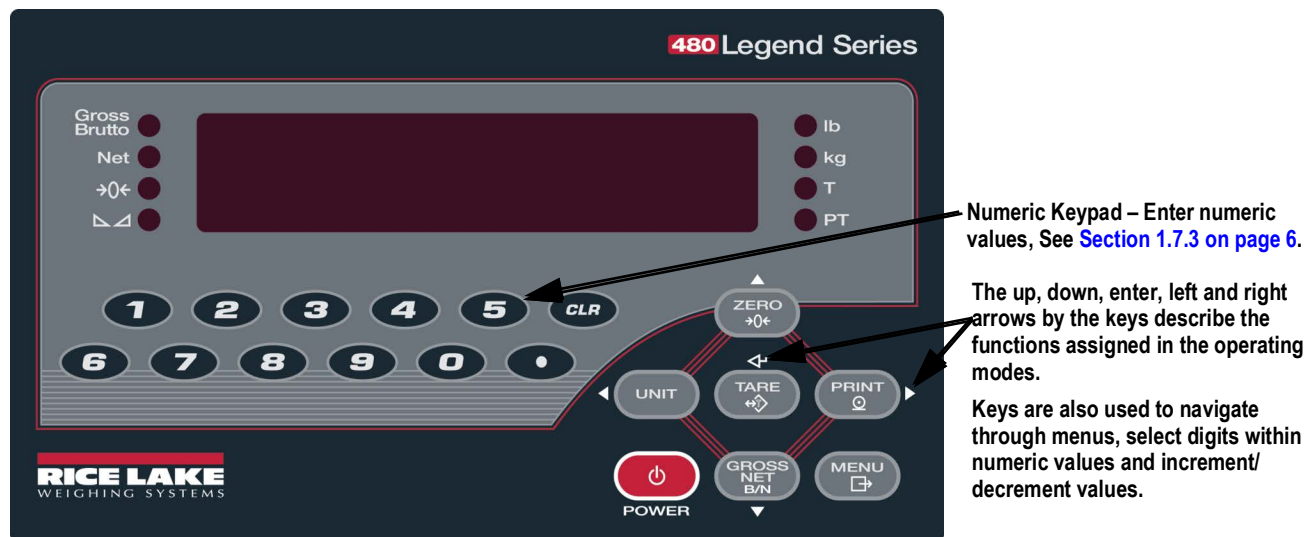

Figure 1-1. 480 Front Panel Key Functions (480 Plus)

1.5 Keypad Functions









Key	Function
 POWER	Turns the unit on/off NOTE: If power mode is set to manual, the Power key must be used to turn the unit on and off. If power mode is set to auto, the unit will automatically power on when it's plugged in and the only way to turn it off is to unplug power, See Section 3.1.7 on page 33.
 MENU	The Menu key is used to access the User Setup menu
 ZERO →0←	Sets the current gross weight to zero, provided the amount of weight to be removed or added is within the specified zero range and the scale is not in motion; the zero band is defaulted to 2% of full scale, but can be configured for up to 100% of full scale; also used as a move up key to navigate to different menu levels or used to increment a number when editing a value
 UNIT	Switches the weight display to an alternate unit; the alternate unit is defined in the Configuration menu and could be kg, g, lb, oz, tn, or t; also used as a scroll left key to navigate to different menus or to toggle to another digit when editing a value
 PRINT	Sends an on-demand print format out the serial port, provided the conditions for standstill are met; PRINT may be displayed while printing; also used as a scroll right key to navigate to different menus or to toggle to another digit when editing a value
 TARE	Performs one of several predetermined tare functions dependent on the mode of operation selected in the TAREFN parameter; to view a stored tare, See Section 1.8.6 on page 7 ; also acts as an Enter key for numeric or parameter entry
 GROSS NET B/N	Switches the display mode from gross to net, or from net to gross. If a tare value has been entered or acquired, the net value is the gross weight minus the tare; gross mode is displayed by the Gross/Brutto annunciator; net mode is displayed by the Net annunciator; also used as a move down key to navigate to different menu levels or to decrement a number when editing a value
 CLR	During a numeric entry, sets the currently select digit to zero then selects one digit to the right

Table 1-1. Keypad Functions

1.6 LED Annunciators

The 480 LED display uses annunciators to provide additional information about the value being displayed.

Number	Name	Function
1	Battery Level	The battery icon indicates the level of the battery
2	Gross/Brutto	Gross weight display mode (or Brutto in OIML mode)
3	Net	Net weight display mode
4	Zero (Center of Zero)	The Center of Zero annunciator indicates that the current gross weight reading is within +/- 0.25 display divisions of the acquired zero, or is within the center of zero band; a display division is the resolution of the displayed weight value, or the smallest incremental increase or decrease that can be displayed or printed
5	Standstill	Scale is at standstill or within the specified motion band; some operations, including zero, tare and printing, can only be done when the standstill annunciator is on
6	T	Indicates a push-button tare weight has been acquired and stored in memory
7	PT	Indicates that a preset tare weight has been keyed in or entered and stored in memory
8	lb / kg / g / oz / t	Displays which unit of measure is being used: lb = pounds kg = kilograms g = grams oz = ounces t = for either short tons and metric tons

Table 1-2. LED Annunciators

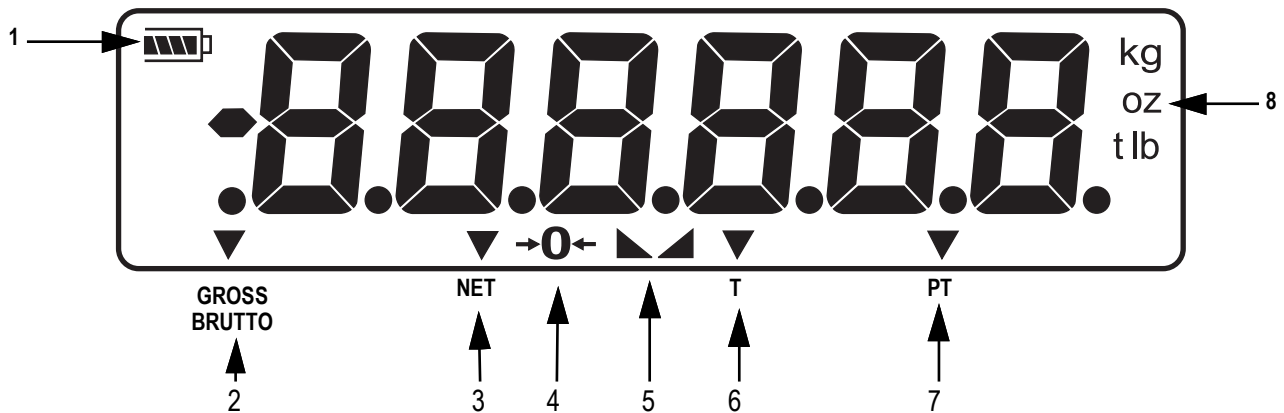

Figure 1-2. LED Annunciators

See [Section 3.2.3 on page 38](#) for more information about configuring primary and secondary display units.

1.7 Front Panel Navigation

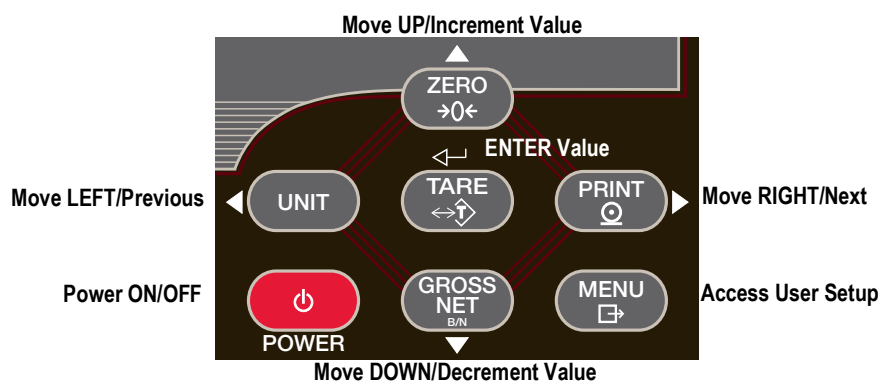
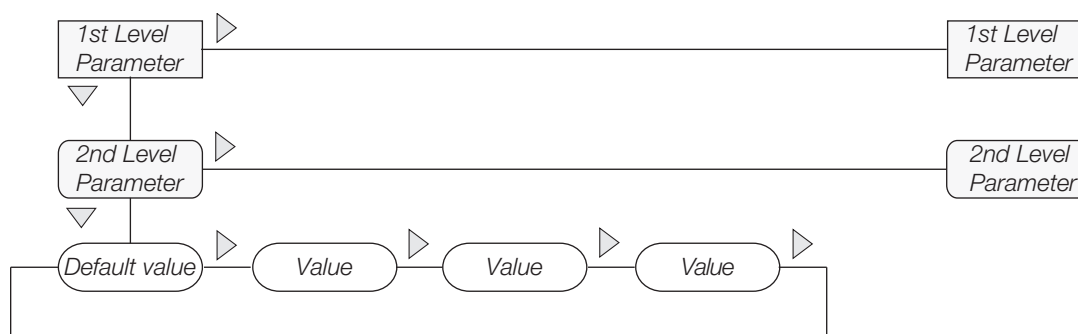

Figure 1-3. Front Panel Key Functions

Four front panel keys are used as directional keys to navigate through the menus, See [Figure 1-3](#).

- **Unit** (◀) and **Print** (▶) scroll left and right on the same menu level
- **Zero** (▲) and **Gross/Net** (▼) move up and down to different menu levels
- The **Tare** key serves as an **Enter** key (↵) for selecting parameter values within the menus
- The **Menu** key allows front panel access to user setup and configuration mode

1.7.1 Navigating Through Levels



When moving through values below the first menu level, press ▲ to return to the level above. Press ○ or ▼ to move to the next parameter on the level below.

Figure 1-4. Menu Navigation

To select a parameter, press ◀ or ▶ to scroll left or right until the desired menu group displays then press ▼ to move down to the desired sub-menu or parameter. When moving through the menu parameters, the present value displays.

1.7.2 Edit Parameter Values

To change a parameter value, scroll left or right to view the values for that parameter. When the desired value displays, press **Tare** (↵) to select the value and move back up one level. To edit numerical values, use the navigation keys to select the digit and to increment or decrement the value.

0 0 0 0 0 0

When editing numeric values, press ◀ or ▶ to change the digit selected. Press ▲ or ▼ to increment or decrement the value of the selected digit. Press ↵ to save the value entered and return to the level above.



Figure 1-5. Editing Procedure for Numeric Values

1.7.3 Numeric Keypad - Editing Procedure for Numeric Values (480 Plus Only)



Figure 1-6. Numeric Keypad for the 480 Plus

With the numeric keypad option, the method for editing numeric values relies on the numbers which are embossed on the keypad rather than using the navigation arrows.

1. When editing numeric values, insert the required value using the numeric keypad.
2. Press **Tare**  to save the value entered and return to the level above.
 - i. Press  to set the currently selected digit to 0
 - ii. Press  to enter a decimal point



Note

When editing fractional numeric values, the decimal point must be positioned in accordance with the primary units formatting, otherwise the keyed number may be rejected by the software.

1.8 Indicator Operations

Basic 480 operations are summarized below.

1.8.1 Menu

Press , **MENU** will be displayed, See [Section 3.1 on page 24](#) for more information.

Press  then  or  to select the following parameters:

- Audit Trail, See [Section 1.8.9 on page 8](#)
- Display Tare, See [Section 1.8.6 on page 7](#)
- Unit ID, See [Section 1.8.10 on page 8](#)
- Accumulator, See [Section 1.8.11 on page 8](#)
- Time and Date, See [Section 1.8.12 on page 9](#)
- Setpoints, See [Section 1.8.13 on page 9](#)
- Serial, See [Section 3.1.2 on page 27](#)
- Print Formats, See [Section 7.0 on page 58](#)
- USB, See [Section 9.8 on page 67](#)
- Ethernet, See [Section 9.9 on page 68](#)
- Version, See [Section 1.8.14 on page 9](#)
- Miscellaneous (Power Option), See [Section 3.1.7 on page 33](#)





Note

Press  repeatedly to return to the weigh mode.

Menus may be password protected, See [Section 1.8.15 on page 10](#) to setup a password.



1.8.2 Zero Scale

1. In Gross mode, remove all weight from the scale and wait for the  annunciator to light.
2. Press . The  annunciator lights to indicate the scale is zeroed.

1.8.3 Toggle Units











Press  to toggle between primary and secondary units. The current unit annunciator will be lit.

1.8.4 Acquire Tare

1. Place container on scale and wait for the  annunciator to light.
2. Press  to acquire the tare weight of the container. Net weight is displayed and the *T* annunciator lights to display the tare value was entered.





See [Section 9.14 on page 72](#) for Regulatory Mode Functions.

1.8.5 Preset Tare (Keyed Tare)

1. With the scale empty and display zeroed, press . *000000* is displayed with the focused digit flashing.
2. Edit the value using the following method; or with the 480 Plus, use the keypad, See [Section 1.7 on page 5](#).
 - Press  or  to select the digit
 - Press  or  to increment or decrement the value
3. Press  when the value is correct. The display will change to the Net mode and the *PT* LED lights to display the preset tare was entered.
 - Press  or  to select the digit
 - Press  or  to increment or decrement the value



1.8.6 Display Tare



When a stored tare value is displayed, the Gross and Net annunciators will be off and the  annunciator will be lit. To display a stored tare:

1. Press .
2. Press  to *AUDIT*.
3. Press  to *TARE*.
4. Press .
5. Press  repeatedly to return to weighing mode.

If there is no tare in the system, *0* will displayed and the gross and net annunciators will be off, See [Section 9.14 on page 72](#) for more information pertaining to the regulatory mode of operation.

1.8.7 Print Ticket

1. Press  to print either the gross or net format.
2. Wait for the  annunciator to light.
3. Press  to send data to the serial port.

If the  annunciator is not lit and  is pressed, the print action will take place only if the scale comes out of motion within three seconds. If the scale stays in motion for over three seconds, the  press is ignored.

1.8.8 Toggle Gross/Net Mode

Press  to switch the display mode between gross and net. If a tare value has been entered or acquired, the net value is the gross weight minus the tare.

Gross mode — *Gross/Brutto* annunciator is lit.



Net mode — *Net* annunciator is lit.

1.8.9 View Audit Trail



See [Section 3.1 on page 24](#) for more information.

1. Press .
2. Press ∇ to **AUDIT**.
3. Press ∇ . The audit trail **CALIB** is displayed.
4. Press ∇ then \triangleleft or \triangleright to **CNT**, **TIME** or **DATE**.
5. Press ∇ to view selected parameter.
6. Press \triangle twice to return to **CALIB**.
7. Press \triangleright to the audit trail **CONFIG** and repeat [Step 5](#) and [Step 6](#) to view configuration number.
8. Press \triangle repeatedly to return to weighing mode.

1.8.10 Enter New Unit ID

1. Press .
2. Press ∇ to **AUDIT**.
3. Press \triangleright until display reads **UNIT ID**.
4. Press ∇ to view the current value.
5. Edit the value using the following method; or with the 480 Plus, use the keypad, See [Section 1.7 on page 5](#).
 - Press \triangleleft or \triangleright to select the digit
 - Press \triangle or ∇ to increment or decrement the value
6. Press  when the value is correct.
7. Press \triangle repeatedly to return to weighing mode.

1.8.11 Display Accumulator

1. Press .
2. Press ∇ to **AUDIT**.
3. Press \triangleright until display reads **ACCUM**.
4. Press ∇ to display **VIEW**.
5. Press \triangleleft or \triangleright to select desired parameter (**VIEW**, **TIME**, **DATE**, **PRINT**, **CLR Y**).
 - i. For **VIEW**, **TIME** or **DATE**, press ∇ to view the value; press \triangle or  to return to selected parameter
 - ii. To print or clear, press ∇ then press  to print or clear the accumulator; press \triangle to return to selected parameter
6. Press \triangle repeatedly to return to weighing mode.

See [Section 3.1 on page 24](#) for the ACCUM menu structure.





Note

If the accumulated value exceeds 999999 then EE ACC displays. The value will still be correct and will print correctly up to 1,000,000,000.

1.8.12 Display or Change Time and Date

To set the date and time:

1. Press .
2. Press ∇ to **AUDIT**.
3. Press \triangleright until display reads **TIMDAT** (Time/Date).
4. Press ∇ and select time or date with \triangleleft or \triangleright .
5. Press ∇ to view the current setting.
6. To edit the value of the time, in 24 hour or 12 hour format (hh.mm.ss), use the following method.
 - Press \triangleleft or \triangleright to select hours, minutes, or seconds – the selected value will be flashing
 - Press \triangle or ∇ to increment or decrement the value
7. Press  when the value is correct. Use the same procedure to enter the date in the same format configured for the indicator, See [Section 3.2.5 on page 40](#) for available formats.
8. Press \triangle repeatedly to return to weighing mode.





Note

The time and date are backed up with an internal battery. If the main power is interrupted, time and date will not be lost. When in 12 hour format, the PT annunciator indicates pm setting.

1.8.13 Display, Edit and Set Setpoint Value

See [Section 8.0 on page 60](#) more information.

1. Press .
2. Press ∇ to **AUDIT**.
3. Press \triangleright until display reads **SETPNT**; See [Section 3.1.1 on page 25](#) for the **SETPNT** menu layout.
4. Press ∇ and navigate across to desired setpoint number (1-8).
5. Press ∇ and navigate across to select **USER**.
6. Press ∇ and navigate across to select **VALUE** or **ENABLE**.
7. Press ∇ to view and edit the value.
 - i. To edit Value, use the following method or with the 480 Plus, use the keypad, See [Section 1.7 on page 5](#)
 - Press \triangleleft or \triangleright to select the digit
 - Press \triangle or ∇ to increment or decrement the value
 - ii. Press  when the value is correct
 - iii. To edit **ENABLE**:
 - Press \triangleleft or \triangleright to select **ON/OFF**
 - Press  when the value is correct
8. Press \triangle repeatedly to return to weighing mode.

1.8.14 View Firmware Version

1. Press .
2. Press ∇ . **AUDIT** is displayed.
3. Press \triangleright until display reads **VERS**.
4. Press ∇ . **FIRMW** is displayed.
5. Press ∇ to view version.
6. Press \triangle repeatedly to return to weighing mode.

1.8.15 Enter User Password

1. Remove the setup switch access screw from the back of the enclosure, See [Figure 2-1 on page 11](#).
2. Insert a non-conductive tool into the access hole and press the configuration switch. Indicator display changes to **CONFIG**.
3. Press ◀ or ▶ until **PASWRD** is displayed.
4. Press ▾. **CNFG** is displayed.
5. Press ▶ to **USER**.
6. Press ▾. **000000** is displayed.
7. To edit the password, use the following method; or with the 480 Plus, use the keypad, See [Section 1.7 on page 5](#):
 - i. Press ◀ or ▶ to select the digit
 - ii. Press ▲ or ▾ to increment or decrement the value
 - iii. Press  when the value is correct
8. Press ▲ to return to **PASWRD**.
9. Press ▶ to **CONFIG**.
10. Press ▲ to return to weighing mode.

When entering a user function, the operator will be required to enter the password.

IMPORTANT

Enter 999999 to reset password, this will also reset the configuration back to default values.

2.0 Installation

2.1 Unpacking

Immediately after unpacking, visually inspect the 480 to ensure all components are included and undamaged. The shipping carton should contain the indicator, this manual, and a parts kit. If parts were damaged in shipment, notify Rice Lake Weighing Systems and the shipper immediately, See [Section 2.8 on page 19](#) for parts kit contents.

2.2 Enclosure Disassembly

The indicator enclosure must be opened to connect the scale load cell cable and other interface connection.

WARNING Before opening the unit, ensure the power cord is disconnected from the power outlet.

Ensure power to the indicator is disconnected then place the indicator face-down on an anti-static work mat. Remove the screws that hold the backplate to the enclosure body. Lift the backplate away from the enclosure and turn it over to access boards.

IMPORTANT The display cable will still be attached. Be careful when lifting and turning over the backplate to prevent the backplate from potential damaged.

2.3 Cable Connections

The 480 provides four cord grips for cabling into the indicator: one for the power cord, three to accommodate load cell, communications, digital inputs and outputs, and analog output cables. Two of the three free cord grips come with a plug installed to prevent moisture from entering the enclosure. Depending on the application, remove the plug from another cord grip that will be used and install cables as required, See [Figure 2-1](#) for the recommended assignments for the 480 cord grips.

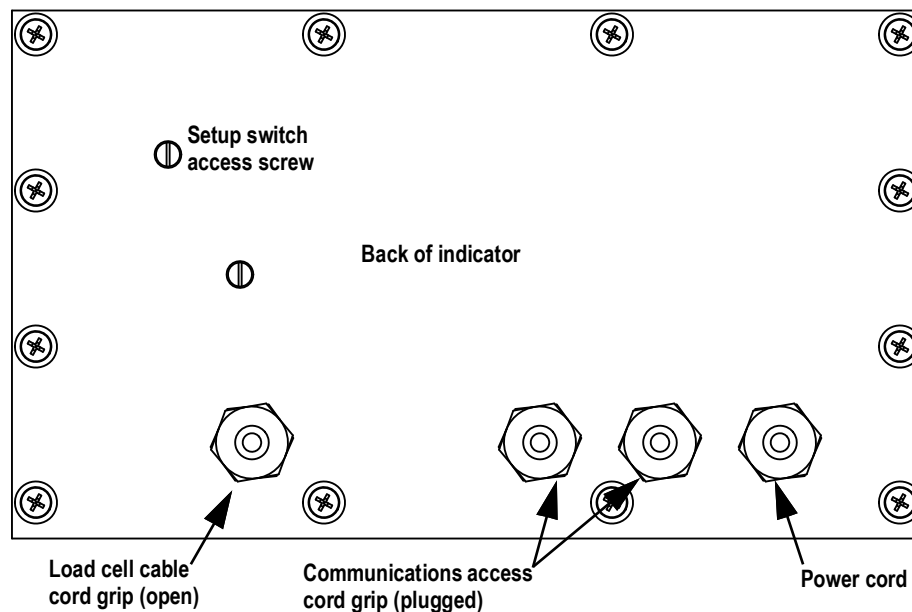

Figure 2-1. Recommended Cord Grip Assignments

IMPORTANT When installing cords through cord grips, ensure the cord grip is tightened snugly to prevent moisture from entering the enclosure. See [Table 2-3 on page 17](#) for required torque values.

2.3.1 Cable Specifications

Cord Grip	Diameter Range
PG9 (PN 15626)	0.138 - 0.315" (3.5 - 8 mm)

Table 2-1. Cord Grip Specifications

2.3.2 Cable Grounding

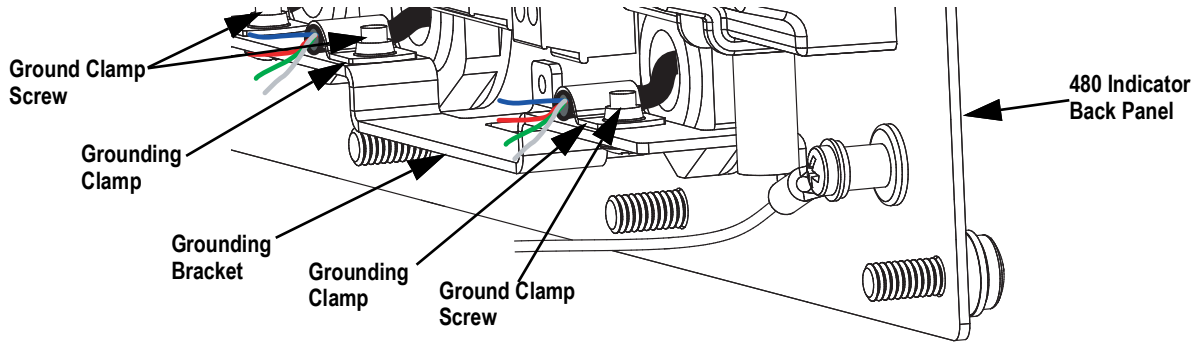

Figure 2-2. Grounding Clamp Attachment

Except for the power cord, all cables routed through the cord grips should be grounded against the indicator enclosure.

1. Install the ground clamps on the grounding bar, use the ground clamp screws. Do not tighten the screws at this time.
2. Route the cables through the cord grips and the grounding clamps to determine the cable lengths required to reach the cable connectors.
3. Mark the cables to remove insulation and shield, See **Stripping Cables** below.
4. Route stripped cables through the cord grips and grounding clamps.
5. Ensure the shields contact the grounding clamps and tighten the ground clamp screws.

2.3.3 Stripping Cables

Foil Insulated Cable

1. Strip the insulation and foil from the cable 1/2" (15 mm) past the grounding clamp.
2. Fold the foil shield back on the cable where the cable passes through the clamp.
3. Ensure the silver (conductive) side of the foil is turned outward for contact with the grounding clamp.

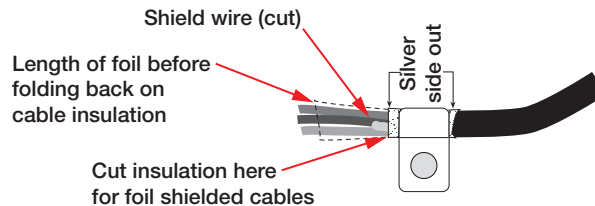

Figure 2-3. Foil Insulated Cable

Braided Shielding

1. Strip the insulation and braided shield from a point just past the grounding clamp.
2. Strip another 1/2" (15 mm) of the insulation to expose the braid where the cable passes through the clamp.

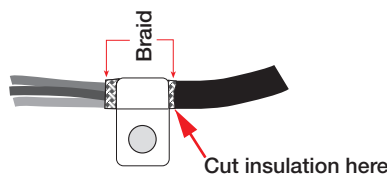

Figure 2-4. Braided Insulated Cable

2.3.4 Load Cell Cables

Cut the shield wire just past the grounding clamp. Shield wire function is provided by contact between the cable shield and the grounding clamp.

2.3.5 Wiring

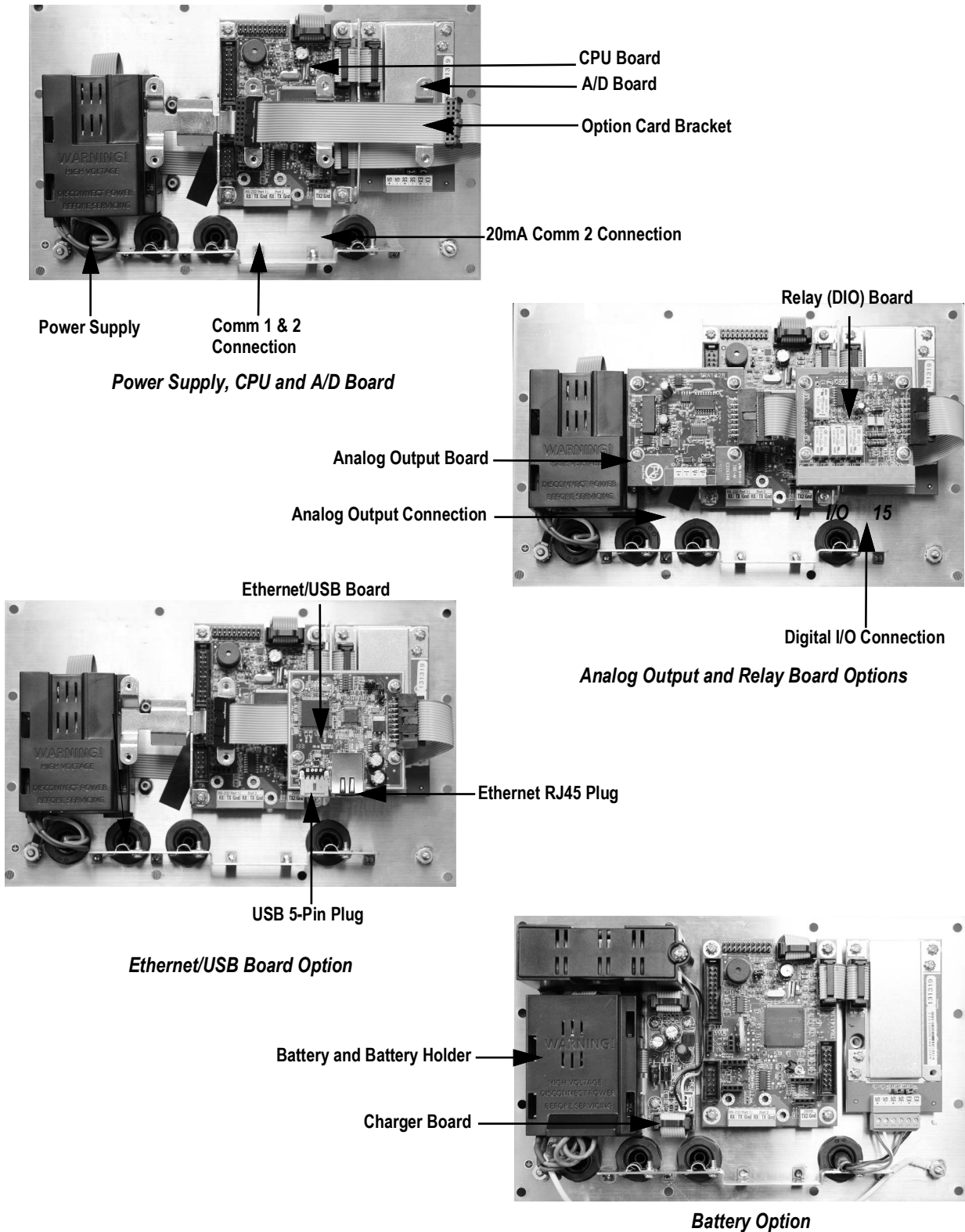

Figure 2-5. 480 Board Options

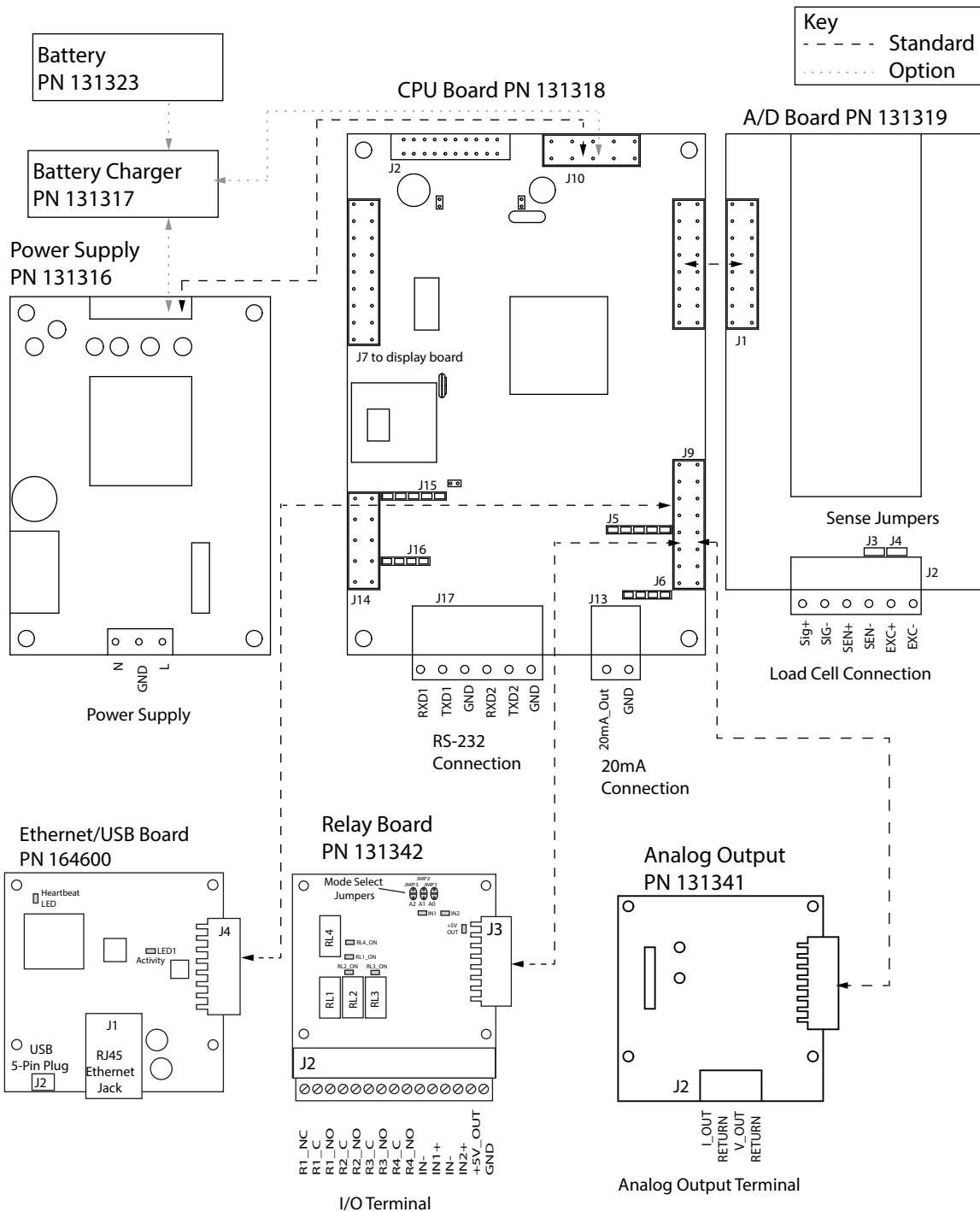

Figure 2-6. Wiring Diagram



- Battery and Battery Charger are optional.**
- Analog and Relay boards require an option card bracket (PN131340) for mounting.**
- To use outputs 1-4 and inputs 1-2, short jumper A1 (JP2).**
- To use outputs 5-8 and inputs 3-4, short jumpers A0 (JP1) and A1 (JP2).**
- Output relay rating of relay 2 AMPS at 30 VDC dry contact relay closure.**
- Digital Input is opto-isolated, activated with 5-24VDC.**
- To use 4-wire load cell cable (with no sense wires), short jumpers J3 and J4.**
- To use 6-wire load cell cable (with sense wires), remove jumpers J3 and J4.**

2.4 Battery Operation

The 480 can be equipped with an optional internal Lithium-Ion battery to provide up to:

- 18 hours of continuous use (single load cell, 350 ohms, no options)
- 15 hours of continuous use (four load cell, 350 ohms, no options)

When operated on AC power, the internal battery is automatically charged by means of an internal battery charger circuit.

The status of the battery is displayed by an icon in the upper left corner of the LED display. When operating on battery power, the icon of the approximate percentage of battery life remaining displays. When connected to AC power, the icon displays if the battery is charging or fully charged.

The following table outlines the meaning of the various battery icon indication levels.







Battery Percent	Battery indicator Level
100% > bat > 75%	4 - Levels 
75% > bat > 50%	3 - Levels 
50% > bat > 25%	2 - Levels 
25% > bat > 10%	1 - Levels 
10% > bat > 5%	0 - Levels 
5% > bat > 0%	Blinking 
0%	Indicator is turned off
Charging	Animated 

Table 2-2. Battery Indication Levels

Battery life depends on several factors, including number of load cells, frequency of use, LED backlight, options installed, temperature, and other accessories being used. Battery charge time is approximately 16 hours to 100%.

To extend battery life, the indicator features a sleep mode that allows the indicator to go into a low power mode while it's operating on battery power, See [Section 9.6 on page 66](#) for more information about the sleep mode.

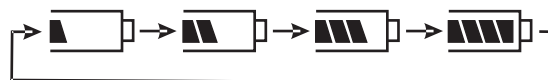

Figure 2-7. Battery Charging Cycle Example



When installing a 480 with a battery option, it is recommended that the CPU board jumper 4 be removed. Removing jumper 4 will maximize the life of the battery when the indicator is turned off due to reduced standby current, See the POWER parameter in [Table 3-8 on page 34](#) for more information.

2.4.1 Option Card Installation

Use the following instructions to install or replace the Analog Output Module (PN 131341), Relay Board (PN 131342) or Ethernet/USB option card (PN 164600).

1. Disconnect power to the indicator.
2. Remove backplate as described in [Section 2.2 on page 11](#).
3. If not already in place, install an option card bracket (PN 131340), See [Figure 2-5 on page 13](#).
4. Mount the analog output module, relay card or the Ethernet/USB option card on the option card bracket. See [Figure 2-5 on page 13](#). The Ethernet/USB option card has to be installed on the option card bracket above the A/D card, not in the location near the power supply.
5. Connect the option card ribbon to the option card(s).
6. Connect the option card ribbon to J9 on the CPU board.
7. Connect output cables, as needed, to the option card(s).



Note

Either option card position can be used for the Analog Output Module, or the Relay Card.

The Ethernet/USB Option Card must be installed in the location above the A/D Card, not next to the Power Supply.

2.5 Board Removal

If the removal of a 480 board is required, use the following procedure:

1. Disconnect power to the indicator.
2. Remove backplate as described in [Section 2.2 on page 11](#).
3. Disconnect all cables from the board.
4. Label connections for re-installation of board.
5. Remove the four screws from the board then lift the board off the backplate.

To install a board, reverse the above procedure. Be sure to reinstall cable ties to secure all cables inside indicator enclosure.



Note

When removing lower boards, the upper boards and option bracket, if installed, will need to be removed first.

2.6 Configurable Back Light

The 480 includes a configurable LED backlight for viewing the display in low-light situations. The backlight can be configured to be **On**, **Off** or in **Auto Mode**. Configure the backlight using the **BKLGHT** parameter, See [Section 3.1.7 on page 33](#).

To set **Auto Mode**, select one of the fixed time settings between 10 seconds and 10 minutes. The backlight will turn off when there has been no change of motion or key presses during the selected time. The backlight will turn back on automatically once there is a change in motion or a key pressed.

The backlight consumes considerable power. Set the backlight to off or use the automatic feature, when operating on battery power.

2.7 Enclosure Reassembly

Once cabling is complete, position the backplate over the enclosure and reinstall the backplate screws. Use the torque pattern in Figure 2-8 to prevent distorting the backplate gasket. Torque screws to 10 in-lb (1 N-m).

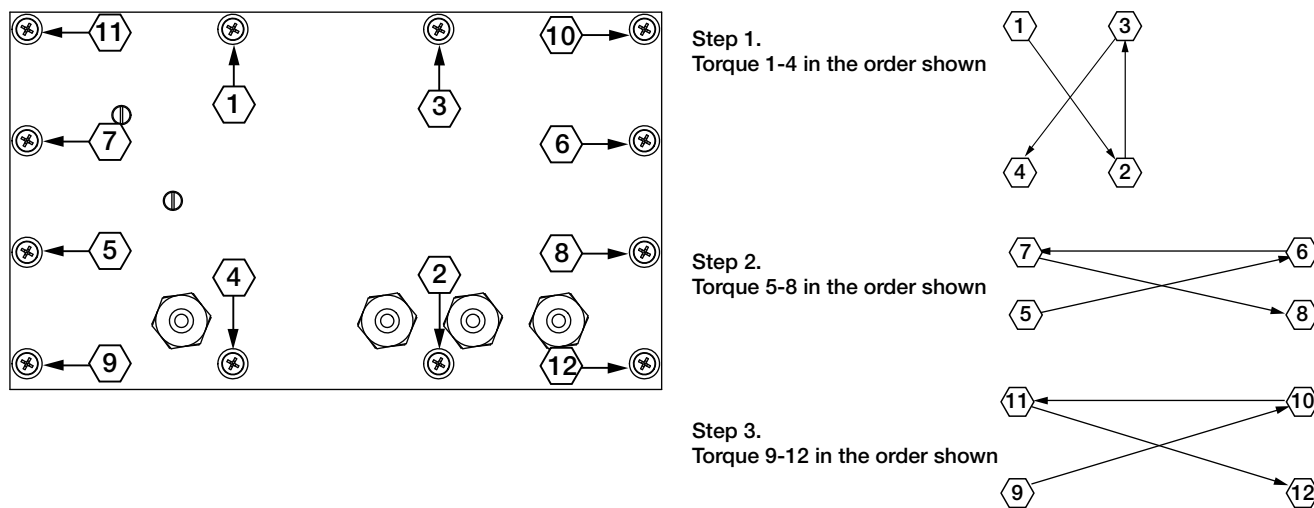

Figure 2-8. 480 Enclosure Backplate

Torque	in-lb	Nm
Backplate screws	10	1
Cord grip nut (to enclosure)	33	3.7
Cord grip dome nut (around cable)	22	2.5
Vent	5-7	0.6-0.8

Table 2-3. Torque Values



Note Torqued screws may become less tight as the gasket is compressed during the torque pattern; a second torque is required using the same pattern and torque value.

2.7.1 Seal the Indicator (Optional)



Note For access to configuration parameters, the setup switch must be pressed.

Prevents Service Access

Insert a lead wire seal through three fillister screws. This prevents access to the electronics, electrical contacts and Legal for Trade configuration parameters.

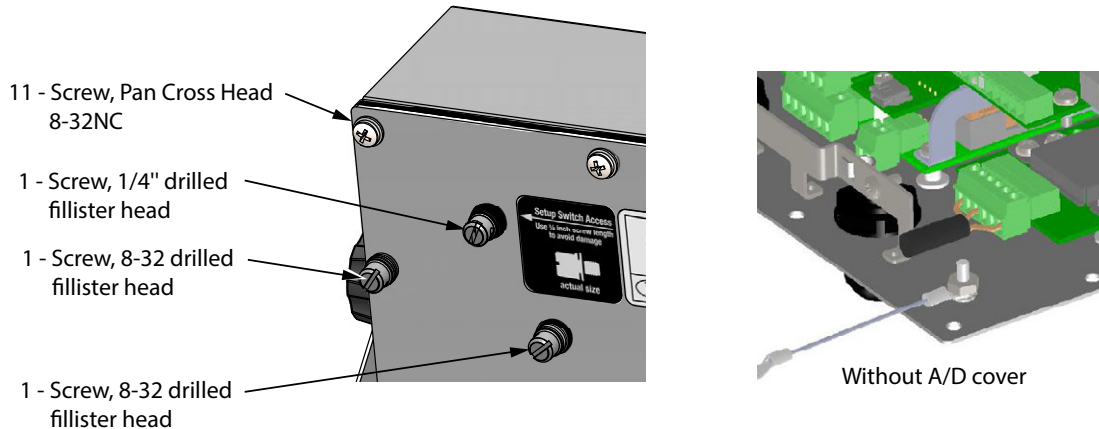

Figure 2-9. Sealing the Indicator to Prevent Access

IMPORTANT

Only use the 1/4 inch screw in the top hole for sealing, using the longer one will damage the CPU board.

Allows Service Access – Optional

The calibration cover is used for inserting a lead wire seal through both fillister screws and the plastic cover. The cover allows access to the electronics and electrical contacts, while preventing access into Legal for Trade configuration parameters.

There is an alternative cover over the A/D to ensure the A/D and load cell connection cannot be changed after the unit is sealed.

There is also an audit trail counter to track calibration and configuration changes made to legally relevant parameters.

Place the calibration cover on the backplate and secure with the existing fillister head screws and o-rings to seal the indicator for Legal for Trade approval.

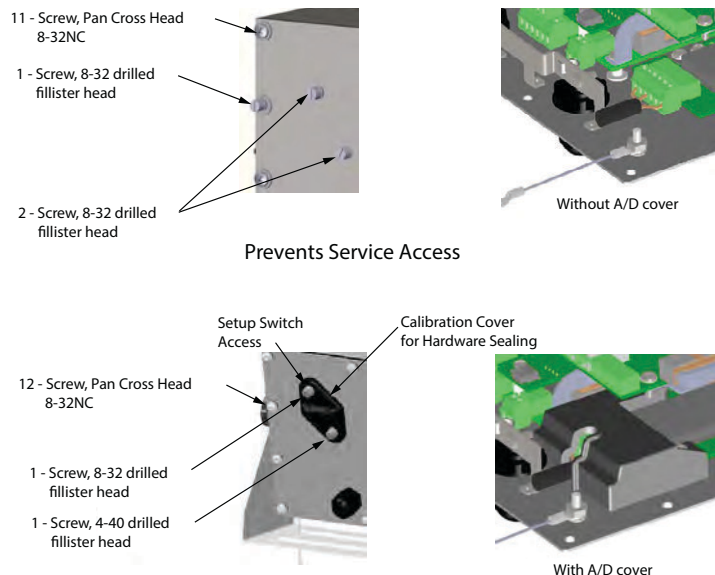

Figure 2-10. Sealing the Indicator to Allow Access Option

2.8 Replacement Parts

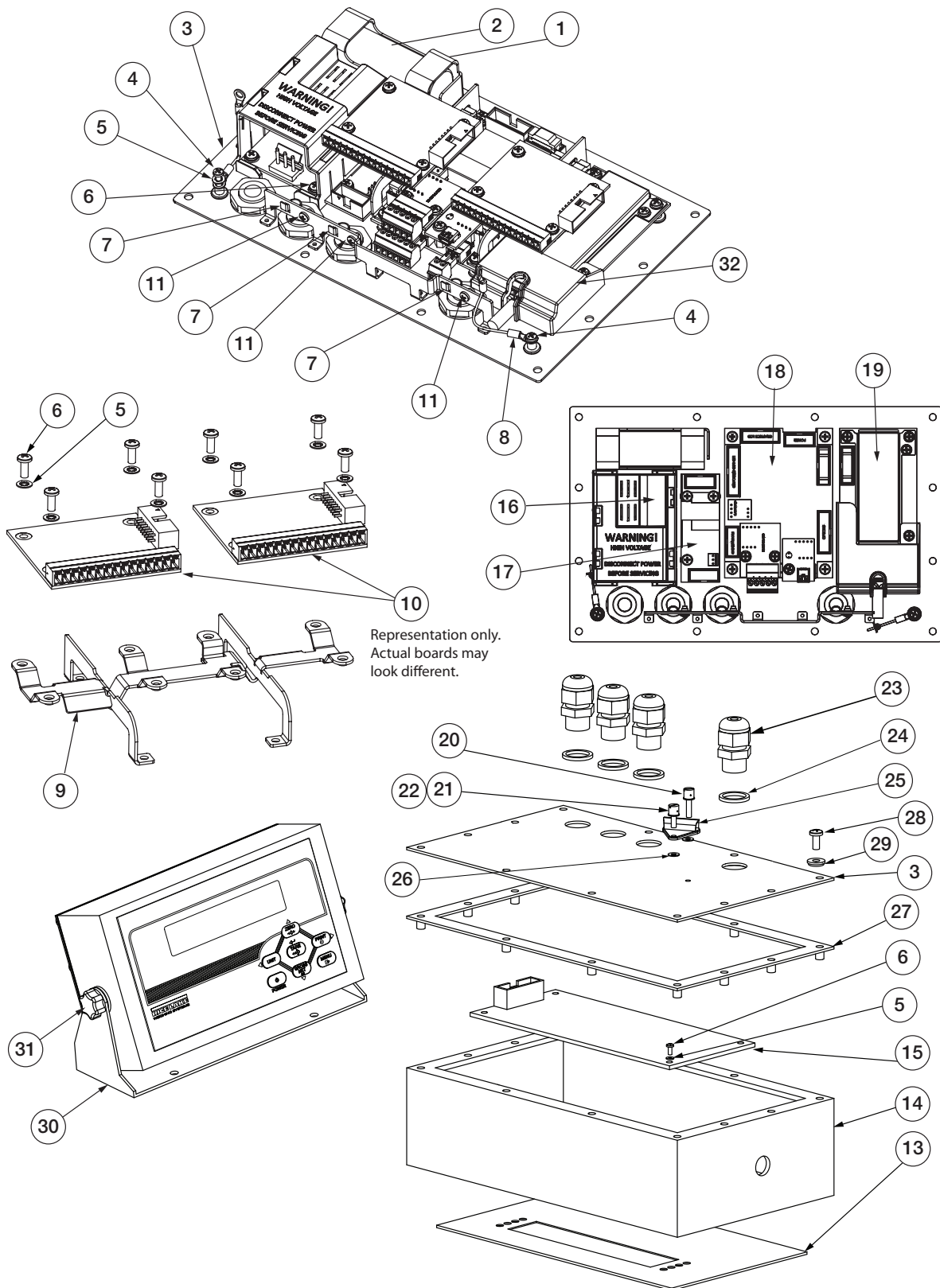

Figure 2-11. Replacement Parts

Item No.	Part No.	Description	Qty
1	131322	Battery bracket (Opt)	1
2	131323	Battery, rechargeable (Opt)	1
3	131321	Backplate, back plane base	1
4	14626	Nut, Kep 8-32 NC Hex	4
5	131326	Lock washer, external tooth	1
6	131328	Screw, 4-40 x 0.3125	1
7	131333	Ground clamp, 3/16 Ø	3
	164580	Ground Clamp, 1/4 Ø	1
8	131334	Ground wire, insulated	2
9	131340	Bracket for option module	1
10	131341	Analog output, 0-10VDC, 4-20 mA	1
	131342	Relay board, 2 inputs, 4 relays	1
	164600	USB/Ethernet TCP/IP	1
11	131327	Screw, 4-40 x 0.188	8
13	161048	Overlay, 480 six-key	1
	161049	Overlay, 480 Plus, numeric keypad	1
14	131343	Enclosure, front	1
15	153776	Display board, LED 7 segment	1
16	131316	Power supply, 85-265 VAC	1
17	131317	Battery charger, VDC to VDC (Opt)	1
18	131318	Board assembly, CPU	1
19	131319	Board, assembly, A/D	1
20	131324	Screw, 4-40 drilled fillister head	1
21	131325	Screw, 8-32 drilled fillister head	1
22	131335	O-ring	2
23	15626	Cord-grip, PG9	4
24	30375	Seal ring, nylon PG9	4
25	131336	Calibration cover (Opt)	1
26	131337	Washer, rubber	2
27	131344	Gasket, backplate	1
28	14862	Screw, 8-32NC x 3/8	4
29	45042	Washer, bonded sealing 8 x 0.375	4
30	164912	Tilt Stand	1
31	164577	Knob & washer, M6 thread	2
32	164579	Cover, A/D Sealing	1

Table 2-4. Parts List

Item No.	Part No.	Description	Qty
NS	164604	Ethernet cable with cord grip, 6 ft	1
	164602	USB cable with cord grip, type A female 20 cm	1
	167707	USB cable with cord grip, type A male 200 cm	1
	167708	USB cable with cord grip, type B male 200 cm	1
	88733	Vent, breather vent	1
	88734	Nut, breather vent	1
	103462	2-position screw terminal	1
	76513	4-position screw terminal	1
	76514	6-position screw terminal	2
	157223	15-position screw terminal	1
	155230	Ribbon cable CPU to display	1
	155231	Ribbon cable CPU to A/D	1
	155232	Ribbon cable PS to CPU Board	1
	155233	Ribbon cable CPU to Option	1
	155234	Pwr cord 115VAC, NEMA Type 5-15 plug	1
	155235	Pwr cord 230VAC, Euro CEE 7/7	1

Table 2-4. Parts List (Continued)

Part No.	Description	Qty
94422	Label, Capacity	1
85555	Label, Annunciators	1
14862	Screw, 8-32NCx3/8	8
45042	Washer, Bonded Sealing #8 x 0.375	8
76514	Conn, 6-Pin for LC and RS-232 ports	2
103462	Conn, 2- Pin for 20 mA port	1
131325	Screw, Fillister 8-32NC x 1/4	1
131320	Screw, Fillister 8-32NC x 1/2	1

Table 2-5. Parts Kit

3.0 Configuration

There are two types of configuration parameters in the 480: Legal for Trade configuration and non-legal configuration or operator parameters. Legal for Trade configuration requires pressing the setup switch, See [Section 3.2 on page 34](#). Non-legal configuration parameters do not require pressing the setup switch, but may be password protected.

The following sections provide graphic representations of the 480 menu structures. In the actual menu structure, the settings chosen under each parameter are arranged horizontally. To save page space, menu choices are displayed in vertical columns. The factory default setting is at the top of each column in bold type. Most menu diagrams are accompanied by a table that describes all parameters and parameter values associated with that menu.

See [Section 1.7 on page 5](#) for navigation methods.

A menu map is provided on the following page for reference.

480/482 Legend Series Configuration Menus

(Press Menu Key to enter, also available when Configuration switch is pressed)

MENU		AUDIT		TARE		UNITID		ACCUM		TIMDPT		SETPNT		SERIAL		ETHNET		USB		PRRMT		VERS		MISC		
VIEW	TIME	DATE	PRINT	CLRY	VIEW	TIME	DATE	PRINT	CLRY	VIEW	TIME	DATE	PRINT	CLRY	TRIGGER	TRIGGER	TRIGGER	TRIGGER	TRIGGER	TRIGGER	TRIGGER	TRIGGER	TRIGGER	TRIGGER	TRIGGER	
ENTER	ENTER	ENTER	ENTER	ENTER	ENTER	ENTER	ENTER	ENTER	ENTER	ENTER	ENTER	ENTER	ENTER	ENTER	ENTER	ENTER	ENTER	ENTER	ENTER	ENTER	ENTER	ENTER	ENTER	ENTER	ENTER	
OFF	OFF	OFF	OFF	OFF	OFF	OFF	OFF	OFF	OFF	OFF	OFF	OFF	OFF	OFF	OFF	OFF	OFF	OFF	OFF	OFF	OFF	OFF	OFF	OFF	OFF	
MANUAL	MANUAL	MANUAL	MANUAL	MANUAL	MANUAL	MANUAL	MANUAL	MANUAL	MANUAL	MANUAL	MANUAL	MANUAL	MANUAL	MANUAL	MANUAL	MANUAL	MANUAL	MANUAL	MANUAL	MANUAL	MANUAL	MANUAL	MANUAL	MANUAL	MANUAL	
WAITSS	WAITSS	WAITSS	WAITSS	WAITSS	WAITSS	WAITSS	WAITSS	WAITSS	WAITSS	WAITSS	WAITSS	WAITSS	WAITSS	WAITSS	WAITSS	WAITSS	WAITSS	WAITSS	WAITSS	WAITSS	WAITSS	WAITSS	WAITSS	WAITSS	WAITSS	
PUSHHAC	PUSHHAC	PUSHHAC	PUSHHAC	PUSHHAC	PUSHHAC	PUSHHAC	PUSHHAC	PUSHHAC	PUSHHAC	PUSHHAC	PUSHHAC	PUSHHAC	PUSHHAC	PUSHHAC	PUSHHAC	PUSHHAC	PUSHHAC	PUSHHAC	PUSHHAC	PUSHHAC	PUSHHAC	PUSHHAC	PUSHHAC	PUSHHAC	PUSHHAC	
LOAD	LOAD	LOAD	LOAD	LOAD	LOAD	LOAD	LOAD	LOAD	LOAD	LOAD	LOAD	LOAD	LOAD	LOAD	LOAD	LOAD	LOAD	LOAD	LOAD	LOAD	LOAD	LOAD	LOAD	LOAD	LOAD	
SELECT	SELECT	SELECT	SELECT	SELECT	SELECT	SELECT	SELECT	SELECT	SELECT	SELECT	SELECT	SELECT	SELECT	SELECT	SELECT	SELECT	SELECT	SELECT	SELECT	SELECT	SELECT	SELECT	SELECT	SELECT	SELECT	SELECT
PREACT	PREACT	PREACT	PREACT	PREACT	PREACT	PREACT	PREACT	PREACT	PREACT	PREACT	PREACT	PREACT	PREACT	PREACT	PREACT	PREACT	PREACT	PREACT	PREACT	PREACT	PREACT	PREACT	PREACT	PREACT	PREACT	PREACT
MASTER	MASTER	MASTER	MASTER	MASTER	MASTER	MASTER	MASTER	MASTER	MASTER	MASTER	MASTER	MASTER	MASTER	MASTER	MASTER	MASTER	MASTER	MASTER	MASTER	MASTER	MASTER	MASTER	MASTER	MASTER	MASTER	MASTER

(Press Configuration Switch to enter)

MENU		CONFG		FORMAT		CALIBR		PROGRAM		DIG.IN		ALGOUT		PASWRD		USBMEM		TEST		MISC				
ENTER	ENTER	ENTER	ENTER	ENTER	ENTER	ENTER	ENTER	ENTER	ENTER	ENTER	ENTER	ENTER	ENTER	ENTER	ENTER	ENTER	ENTER	ENTER	ENTER	ENTER	ENTER	ENTER		
VIEW	VIEW	VIEW	VIEW	VIEW	VIEW	VIEW	VIEW	VIEW	VIEW	VIEW	VIEW	VIEW	VIEW	VIEW	VIEW	VIEW	VIEW	VIEW	VIEW	VIEW	VIEW	VIEW		
0	0	0	0	0	0	0	0	0	0	0	0	0	0	0	0	0	0	0	0	0	0	0		
25%	25%	25%	25%	25%	25%	25%	25%	25%	25%	25%	25%	25%	25%	25%	25%	25%	25%	25%	25%	25%	25%	25%	25%	
50%	50%	50%	50%	50%	50%	50%	50%	50%	50%	50%	50%	50%	50%	50%	50%	50%	50%	50%	50%	50%	50%	50%	50%	50%
100%	100%	100%	100%	100%	100%	100%	100%	100%	100%	100%	100%	100%	100%	100%	100%	100%	100%	100%	100%	100%	100%	100%	100%	100%

Menu Navigation

Edit Numeric Values

0 0 0 0 0 0

When editing numeric values, press < or > to change the digit selected. Press Δ or ∇ to increment or decrement the value of the selected digit. Press <-> to save the value entered and return to the level above.

Level Layout

Level 1

Level 2

Level 3

Level 4

All levels are scrolled through using < or >
Level four is shown as a vertical list for illustration purpose only.

OFF ZERO TARE NTGRS UNITS DFSTAR PRINT CLRCON KBDLOC HOLD CLRTRAR ACCUM CLRACC BATSTR BATPUS BATRES BATRTR NET GROSS PRI SEC

PRIMAR		SECNDR		WZERO		WVAL		WSPAN		REZERO		ZTRKBN		ZFRANZ		INZR		MOTBN		OVRLOA		DSPRAT		SMRPRAT		DIGFIL		ADPFIL		ROLFIL		TAREFN				
ENTER	ENTER	ENTER	ENTER	ENTER	ENTER	ENTER	ENTER	ENTER	ENTER	ENTER	ENTER	ENTER	ENTER	ENTER	ENTER	ENTER	ENTER	ENTER	ENTER	ENTER	ENTER	ENTER	ENTER	ENTER	ENTER	ENTER	ENTER	ENTER	ENTER	ENTER	ENTER	ENTER	ENTER	ENTER	ENTER	
VALUE	VALUE	VALUE	VALUE	VALUE	VALUE	VALUE	VALUE	VALUE	VALUE	VALUE	VALUE	VALUE	VALUE	VALUE	VALUE	VALUE	VALUE	VALUE	VALUE	VALUE	VALUE	VALUE	VALUE	VALUE	VALUE	VALUE	VALUE	VALUE	VALUE	VALUE	VALUE	VALUE	VALUE	VALUE	VALUE	
1d	1d	1d	1d	1d	1d	1d	1d	1d	1d	1d	1d	1d	1d	1d	1d	1d	1d	1d	1d	1d	1d	1d	1d	1d	1d	1d	1d	1d	1d	1d	1d	1d	1d	1d	1d	
2d	2d	2d	2d	2d	2d	2d	2d	2d	2d	2d	2d	2d	2d	2d	2d	2d	2d	2d	2d	2d	2d	2d	2d	2d	2d	2d	2d	2d	2d	2d	2d	2d	2d	2d	2d	2d
5d	5d	5d	5d	5d	5d	5d	5d	5d	5d	5d	5d	5d	5d	5d	5d	5d	5d	5d	5d	5d	5d	5d	5d	5d	5d	5d	5d	5d	5d	5d	5d	5d	5d	5d	5d	5d
10d	10d	10d	10d	10d	10d	10d	10d	10d	10d	10d	10d	10d	10d	10d	10d	10d	10d	10d	10d	10d	10d	10d	10d	10d	10d	10d	10d	10d	10d	10d	10d	10d	10d	10d	10d	10d
20d	20d	20d	20d	20d	20d	20d	20d	20d	20d	20d	20d	20d	20d	20d	20d	20d	20d	20d	20d	20d	20d	20d	20d	20d	20d	20d	20d	20d	20d	20d	20d	20d	20d	20d	20d	20d
50d	50d	50d	50d	50d	50d	50d	50d	50d	50d	50d	50d	50d	50d	50d	50d	50d	50d	50d	50d	50d	50d	50d	50d	50d	50d	50d	50d	50d	50d	50d	50d	50d	50d	50d	50d	50d
100d	100d	100d	100d	100d	100d	100d	100d	100d	100d	100d	100d	100d	100d	100d	100d	100d	100d	100d	100d	100d	100d	100d	100d	100d	100d	100d	100d	100d	100d	100d	100d	100d	100d	100d	100d	100d

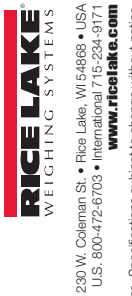

230 W. Coleman St. • Rice Lake, WI 54688 • USA
U.S. 800-472-6703 • International 715-234-9171
www.ricelake.com

© Rice Lake Weighing Systems. Specifications subject to change without notice.
Rice Lake Weighing Systems is an ISO 9001 registered company.

PN 168350 Rev.B

December 2, 2015

3.1 User Menu Setup

Press the **Menu** key to access the menu parameters.



The Menu key can be pushed while in the weigh mode. The configuration parameters can be accessed by pressing the setup switch while in the User Menu, See Section 3.2 on page 34 for configuration setup.

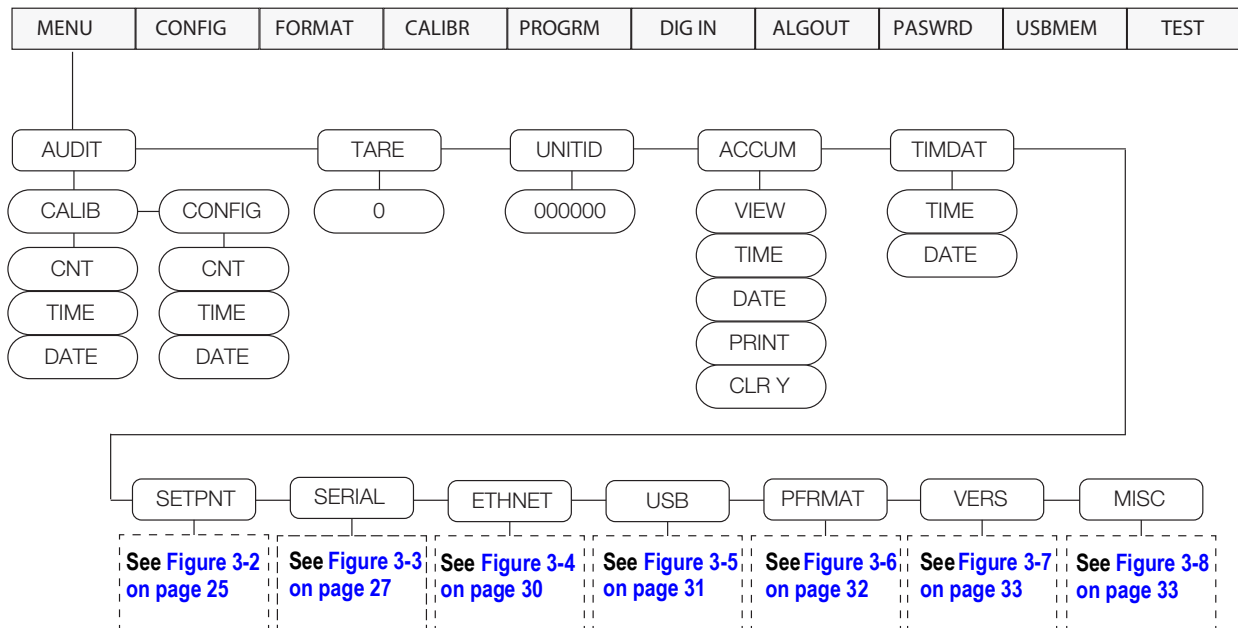

Figure 3-1. Menu Key User Menu

Parameter	Choices	Description
AUDIT	CALIB CONFIG	View audit trail including the time and date of last configuration or calibration; options: CNT, TIME, DATE
TARE	0	View the Tare value
UNITID	0–999999	View and edit the Unit ID (up to a six digit number)
ACCUM	VIEW TIME DATE PRINT CLR Y	View the current accumulator value; view the time and date of the last accumulation; print or clear the accumulator data
TIMDAT	TIME DATE	View/set time and date as currently programmed in the indicator; See Section 1.8.12 on page 9; format date as MMDDYY, DDMMYY, YYMMDD or YYDDMM
SETPNT	BATCHG SETPNT1-8	See Section 3.1.1 on page 25
SERIAL	COM-1 COM-2 STREAM	Configure serial ports, See Section 3.1.2 on page 27
ETHNET	DHCP IPADR NETMSK DFTGWY MAC SERVER CLIENT	Configure optional Ethernet ports, See Section 3.1.3 on page 30
USB	DEVICE TRIGGER	Configure optional USB port; See Section 3.1.4 on page 31

Table 3-1. Menu Key Parameters

Parameter	Choices	Description
PFRMAT	GFMT NFMT ACCFMT SPFMT	View or configure the print format used for gross, net ticket, accumulator and setpoint print tickets; See Section 7.0 on page 58 for more information; See Section 3.1.5 on page 32
VERS	FIRMW LR	Displays the firmware and legally relevant firmware currently installed
MISC	POWER BKLIGHT BAT	Set miscellaneous parameters; See Section 3.1.7 on page 33

Table 3-1. Menu Key Parameters (Continued)

3.1.1 Setpoint Menu

The SETPNT menu is used to access and modify setpoint data. For more information on setpoints, See [Section 8.0 on page 60](#).

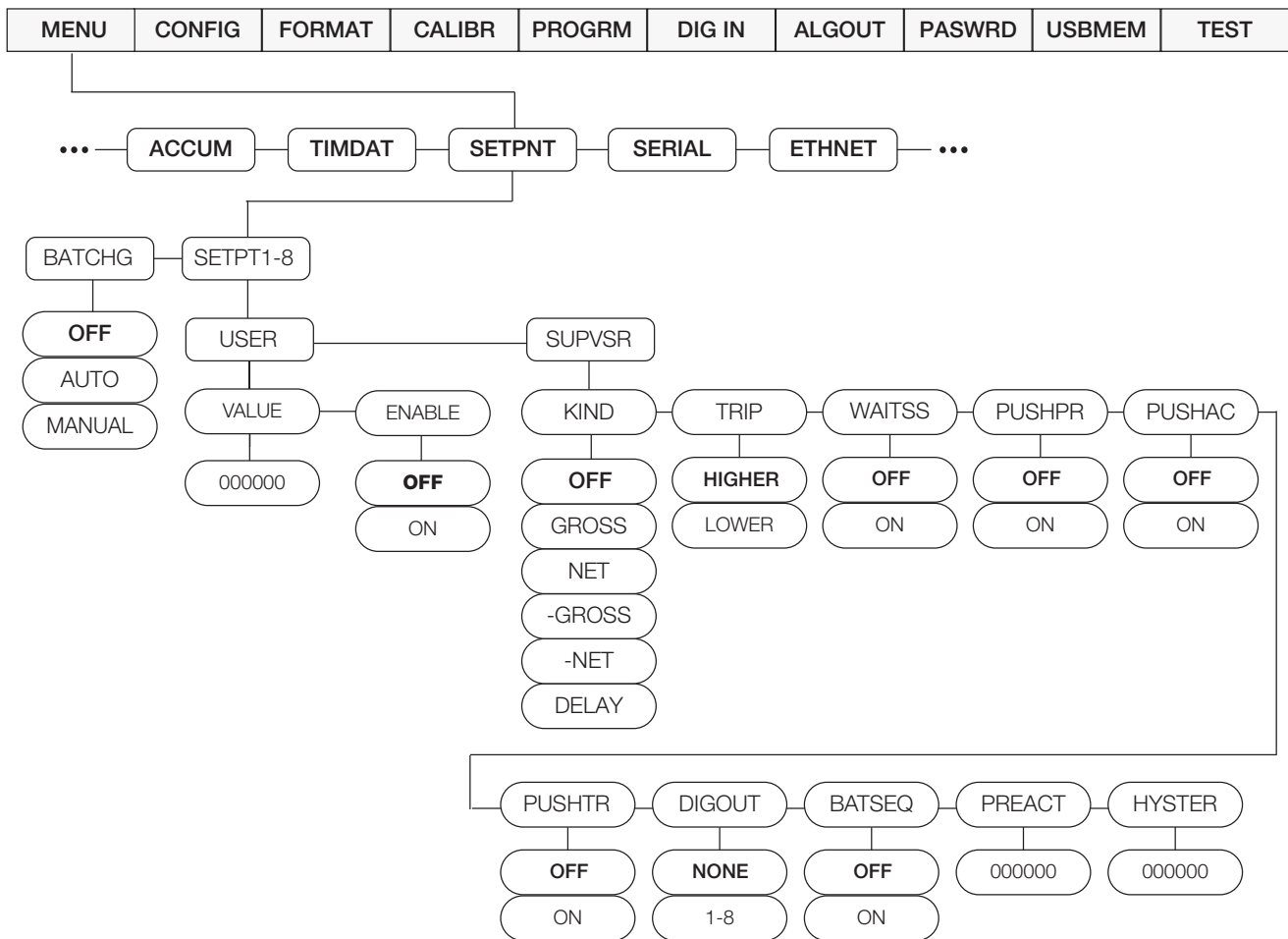

Figure 3-2. Setpoint Setup Menu

Parameter	Choices	Description
SETPT1-8	USER SUPVSR	Setpoint options that do not require a user password, see sub-menu below; setpoint options that require a user password, see Supervisor Sub-menu below
BATCHG	OFF AUTO MANUAL	Set to OFF batching is disabled; set to AUTO or MANUAL to allow a batch sequence to run; MANUAL requires a batch start signal (BATSTRT digital input or BATSTART serial command) before the batch sequence runs; AUTO allows batch sequences to repeat continuously after receiving a batch start signal
User Sub-menus		
VALUE	number	Display and edit the setpoint target value: <ul style="list-style-type: none"> For weight-based setpoints: specifies the target weight value, 0–999999 For time-based setpoints (delay): specifies, in 0.1-second intervals, a time value in the range 0–65535
ENABLE	OFF ON	Enable or disable the setpoint
Supervisor Sub-menus		
KIND	--	Specifies the setpoint kind and determines whether function is based on GROSS or NET weight or based on time value for delay
	OFF	Setpoint turned off/ignored
	GROSS	Gross setpoint; performs functions based on the gross weight; the target weight entered is considered a positive gross weight
	NET	Net setpoint; performs functions based on the net weight; the target weight entered is considered a positive net weight value
	-GROSS	Negative gross weight; performs functions based on the gross weight; the target weight entered is considered a negative gross weight
	-NET	Negative net weight; performs functions based on the net weight; the target weight entered is considered a negative net weight value
	DELAY	Delays the batch sequence for a specified time; the length of the delay (in tenths of a second) is specified by the VALUE parameter
TRIP	HIGHER LOWER	Trips the setpoint when the weight is higher or lower than the setpoint value: If batch sequence is off (Continuous Setpoint) with: <ul style="list-style-type: none"> TRIP = HIGHER – the associated digital output will become active when the weight value is higher than the setpoint value TRIP = LOWER – the output is active when the weight is below the setpoint value If batch sequence is on (Batching Setpoint) with: <ul style="list-style-type: none"> TRIP = HIGHER – the associated digital output is active until the setpoint value is reached or exceeded TRIP = LOWER – the output is active until the weight goes below the setpoint value
	WAITSS	OFF ON
PUSHPR	OFF ON	Push Print – specify ON to perform a print operation when the setpoint is satisfied; this action does not wait for standstill, it prints as soon as the setpoint is satisfied; to wait for standstill before printing, set the WAITSS parameter to ON ; this action uses the Setpoint Print Format
PUSHAC	OFF ON	Push Accumulator – specify ON to update the accumulator when the setpoint is satisfied; this action does not wait for standstill, it accumulates as soon as the setpoint is satisfied; to wait for standstill before accumulating, also set the WAITSS parameter to ON
PUSHTR	OFF ON	Push Tare – specify ON to perform an acquire tare operation when the setpoint is satisfied; this action does not wait for standstill, it tares the weight as soon as the setpoint is satisfied; to wait for standstill before performing the tare, also set the WAITSS parameter to ON NOTE: PUSHTR acquires the tare regardless of the value specified for the REGULAT parameter on the PROGRAM menu.
DIGOUT	NONE 1-8	Digital Output – specify the digital output associated with this setpoint NOTE: To use outputs 1-4 and inputs 1-2, short jumper A1 (JP2). To use outputs 5-8 and inputs 3-4, short jumpers A0 (JP1) and A1 (JP2).
BATSEQ	OFF ON	Determines if the setpoint is a continuously running setpoint (OFF), or part of a batch sequence (ON)
PREACT	number	Allows a setpoint to shut off before the setpoint is satisfied to allow for material in suspension
HYSTER	number	Specifies a band around the setpoint value that must be exceeded before the setpoint, once off, can trip on

Table 3-2. Setpoint Setup Menu Parameters

3.1.2 Serial Menu

The SERIAL menu is used to access the serial settings of the device. For information about the 480 serial data format, See [Section 9.3 on page 63](#).

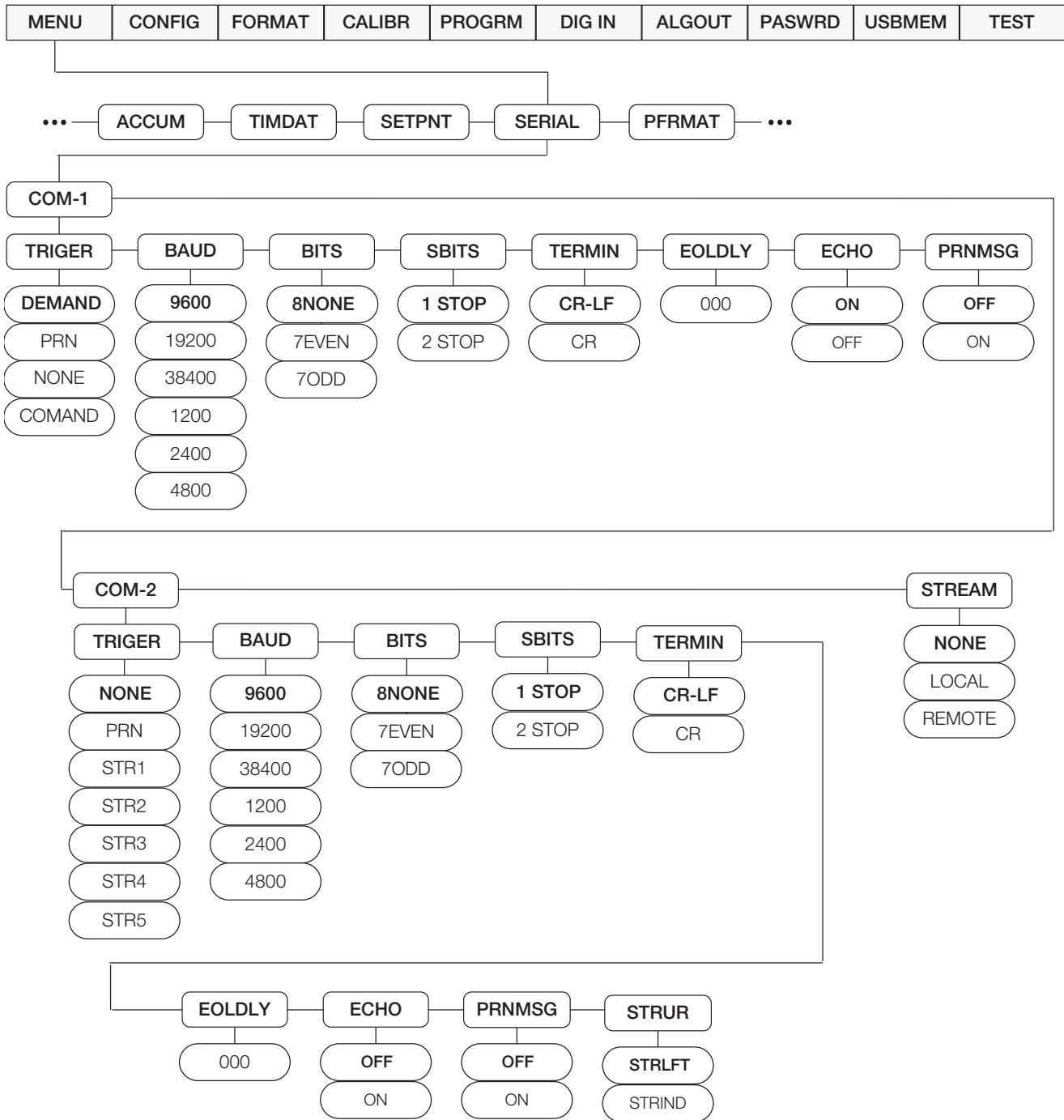

Figure 3-3. Serial Menu

Parameter	Choices	Description
COM-1	TRIGGER BAUD BITS SBITS TERMIN EOLDLY ECHO PRNMSG	Specifies settings for COM-1
COM-2	TRIGGER BAUD BITS SBITS TERMIN EOLDLY ECHO PRNMSG STRUR	Specifies settings for COM-2
STREAM	--	Specifies the operating mode of the indicator, See Section 9.4 on page 66
	NONE	Indicator operates normally, COM-2 will not stream, even if the TRIGGER is set to a streaming parameter (STR1-5)
	LOCAL	Indicator operates normally, data streaming occurs on COM-2 if the TRIGGER is set to stream data (STR1-5)
	REMOTE	Indicator acts as a Serial Data scale, displaying values based on a received stream of Serial Data into COM-2; it also sends key press commands back through COM-2 to the Local indicator.
Sub-menus COM-1 and COM-2		
TRIGGER (COM-1)	--	Specifies the ports mechanism for triggering a transmission of data
	DEMAND	Demand port – printing is performed by pressing the Print key or when a KPRINT EDP command is received; this port will also allow operation and EDP commands
	PRN	Printer Port – printing is performed by pressing the Print key; the port does not allow operation of EDP commands
	NONE	Port is inactive
	COMAND	Command port – allows operation of EDP commands, but will not print
TRIGGER (COM-2)	NONE	Port is inactive
	PRN	Printer Port – printing is performed by pressing the Print key; the port does not allow operation of EDP commands
	STR1	Port is used to transmit a continuous stream of data according to RLWS stream format**
	STR2	Port is used to transmit a continuous stream of data according to Toledo8142 stream format*
	STR3	Port is used to transmit a continuous stream of data according to Cardinal738 stream format*
	STR4	Port is used to transmit a continuous stream of data according to Weightronix WI-120 stream format*
	STR5	Port is used to transmit a continuous stream of data according to consolidated stream format*
*STREAM must be set to local to enable streaming NOTE: See Section 9.3 on page 63 for more information on Stream formats. Com-2 streams simultaneously on both the RS-232 and 20mA outputs.		
BAUD	9600 19200 38400 1200 2400 4800	Baud rate. Selects the transmission speed of data
BITS	8NONE 7EVEN 7ODD	Selects number of data bits and parity of data

Table 3-3. Serial Menu Parameters

Parameter	Choices	Description
SBITS	1 STOP 2 STOP	Stop bits – sets the number of stop bits to 1 or 2
TERMIN	CR/LF CR	Termination character – selects line termination character(s) for data sent
EOLDLY	000000 0–255	End-of-line delay – specifies, in 0.1 second intervals, the delay between transmitted lines of data NOTE: An end-of-line delay may be required for continuous transmission at slower baud rates to ensure the receiving buffer is empty before another string is transmitted.
ECHO	ON OFF	Specifies whether characters received by the port are echoed back to the sending unit NOTE: Port 1 default is ON, Port 2 default is OFF.
PRNMSG	OFF ON	Print displays when a demand print is performed
STRUR	--	Com 2 only – defines the stream data update rate when one of the stream formats is selected
	STRLFT	Stream Legal for Trade – the weight information in the data stream is updated at the same rate as the indicator's display
	STRIND	Stream industrial – the weight information in the data stream is updated at up to the A/D sample rate

Table 3-3. Serial Menu Parameters (Continued)

3.1.3 Ethernet Menu

The ETHNET menu is used to view and edit device address information.

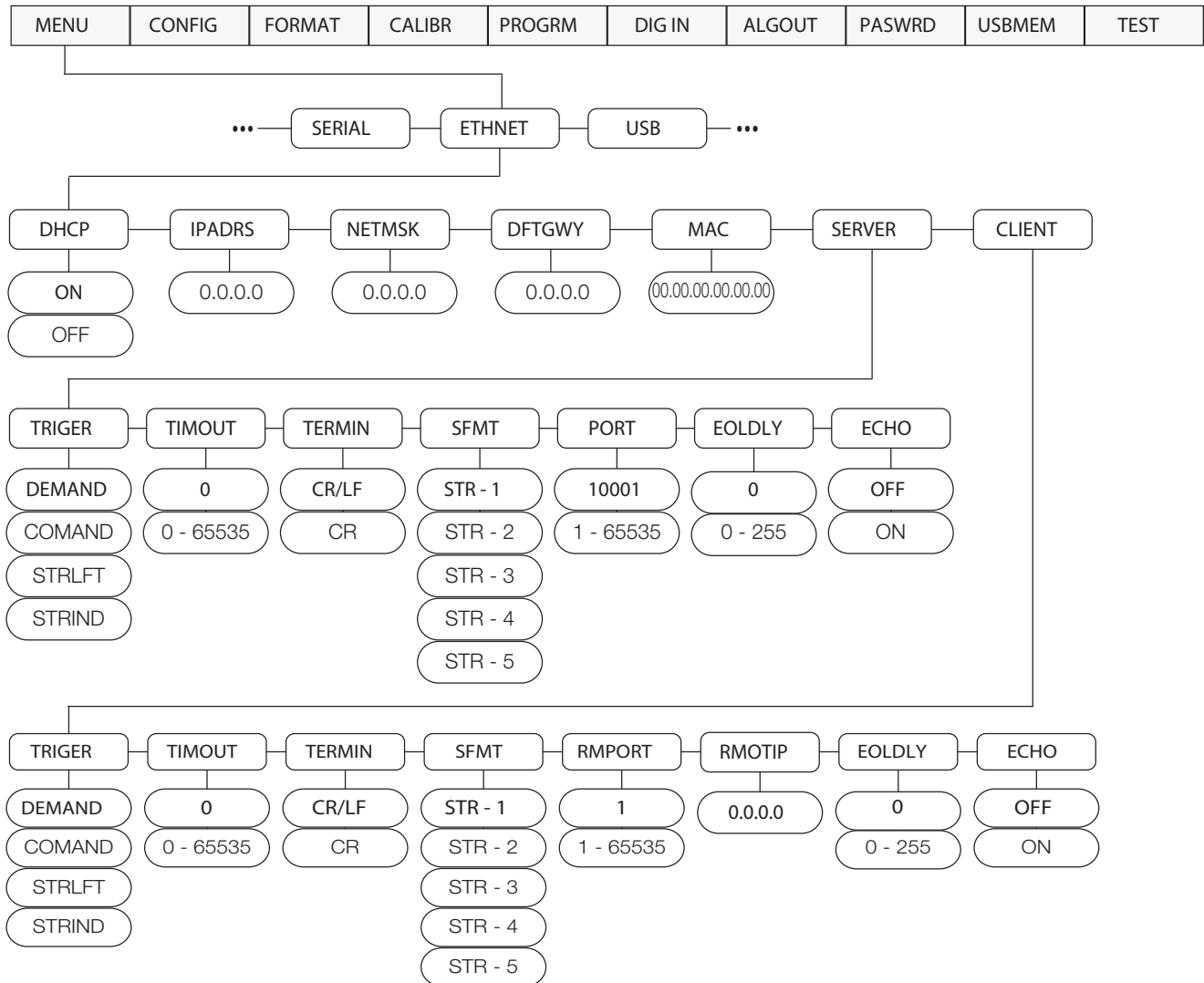

Figure 3-4. Ethernet Menu

Parameter	Choices	Description
DHCP	ON OFF	Dynamic Host Configuration Protocol (DHCP) ON – Dynamic allocation of IP address OFF – Static allocation of IP address
IPADRR	0.0.0.0	IP address, a four field value, the range of each field is 0-255
NETMSK	0.0.0.0	SUBNET mask, a four field value, the range of each field is 0-255
DFTGWY	0.0.0.0	Default gateway, a four field value, the range of each field is 0-255
MAC	00.00.00.00.00.00	View the MAC Address in hexadecimal base (read only)
SERVER	--	See Sub-menu below
CLIENT	--	See Sub-menu below

Table 3-4. Ethernet Menu Parameters

3.1.4 USB Menu

The USB menu is used to change the device and language format.

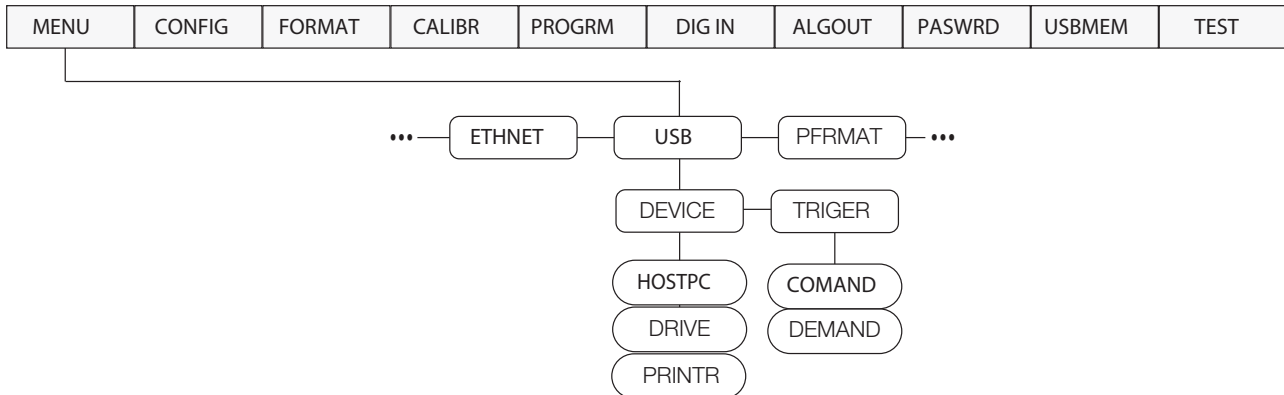

Figure 3-5. USB Menu

Parameter	Choices	Description
DEVICE	HOSTPC	The port is assigned to a HOSTPC, the protocol is a demand type similar to serial communications demand mode, meaning that the port supports EDP commands and Printing
	DRIVE	The port is assigned to a flash drive, the data is written in a FAT32 system, no special driver is required; use the USBMEM Load and Save functions, found in the Configuration Menu, See Section 3.2.1 on page 35 , to load configuration data to or from a flash drive
	PRINTR	When set to PRINTR mode, the USB port can be connected to a USB printer using an appropriate USB cable, See Section 9.8 on page 67
TRIGER	COMAND	Allows operation of EDP commands and prints
	DEMAND	Allows operation of EDP commands only; does not print

Table 3-5. USB Parameters

3.1.5 Print Format Menu

The PFRMAT menu is used to change the print format. For information about custom print formatting, See [Section 7.0 on page 58](#).

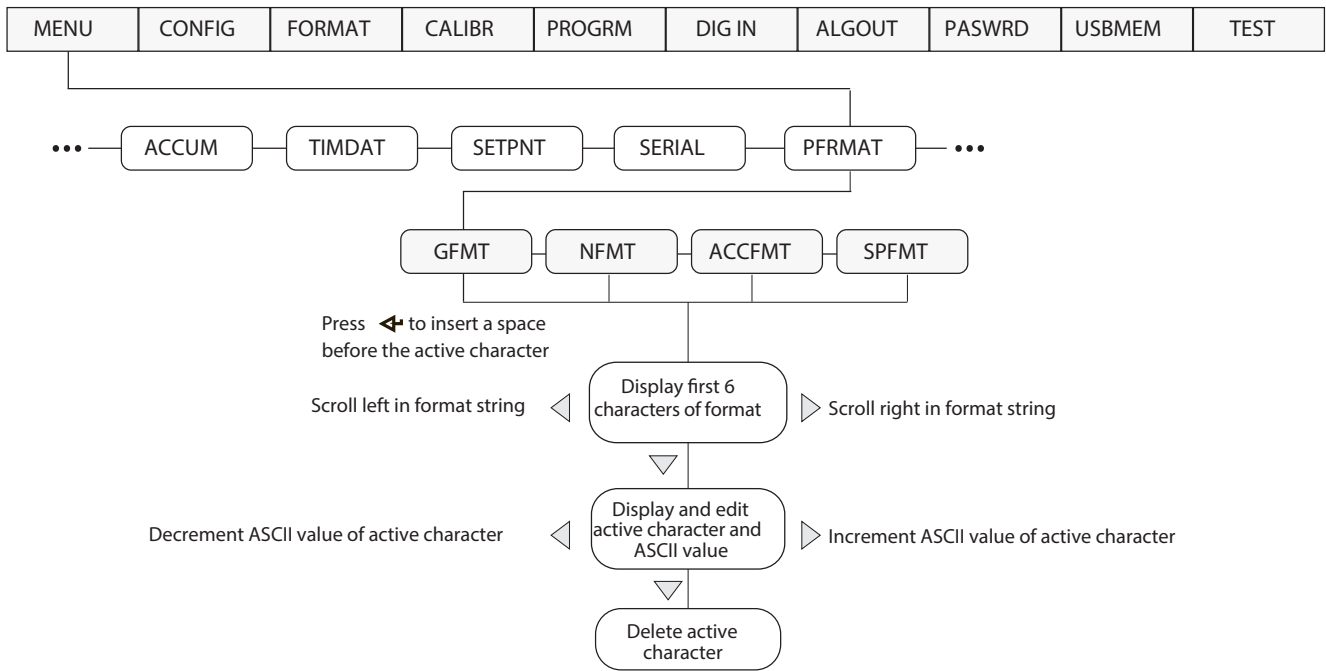

Figure 3-6. Print Format Menu

Parameter	Description
GFMT	Gross demand print format string Default – GROSS<G><NL2><TD><NL>
NFMT	Net demand print format string Default – GROSS<G><NL>TARE<SP><T><NL>NET<SP2><N><NL2><TD><NL>
ACCFMT	Accumulator demand print format string Default – ACCUM <A><NL><DA><SP><TI><NL>
SPFMT	Setpoint print format Default – <SCV><SP><SPM><NL>

Table 3-6. Print Format Menu



Note Format strings are case sensitive and must be entered in upper case.

3.1.6 Version Menu

The VERS menu is used to view the firmware version.

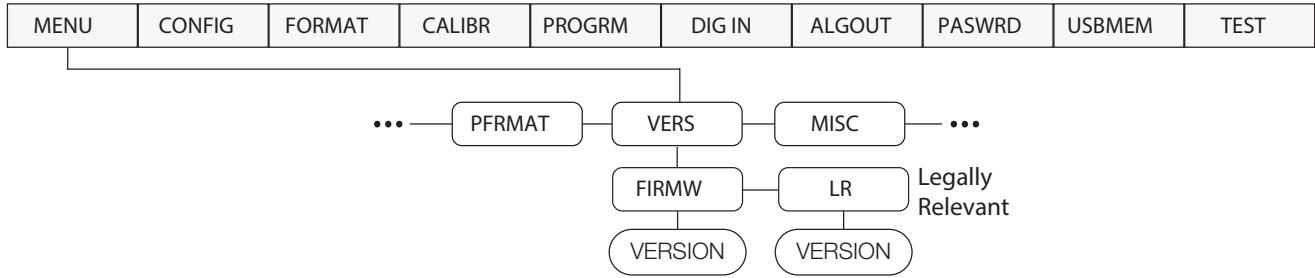

Figure 3-7. Version Menu

Parameter	Description
FIRMW	Displays firmware version
LR	Displays legally relevant firmware version

Table 3-7. Version Menu Parameters

3.1.7 MISC Menu

The MISC menu is used to access the optional features of the device.

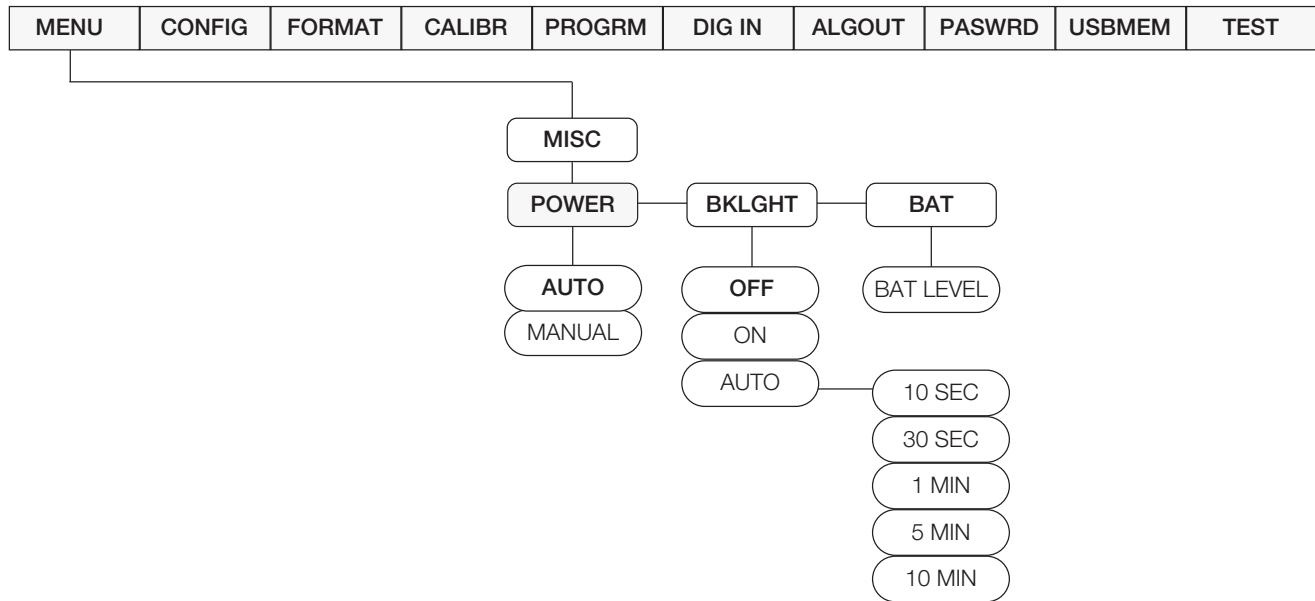

Figure 3-8. Miscellaneous Menu

Parameter	Choices	Description
POWER	AUTO	The power up functionality depends on whether the battery option is installed: <ul style="list-style-type: none"> If the battery option is not installed, the indicator turns on automatically when connected to AC power; it turns off by disconnecting the AC power or by pressing the Power key If the battery option is installed, and CPU Jumper 4 is connected, the indicator turns on automatically when connected to AC power; it turns off by disconnecting the AC power or by pressing the Power key; this configuration is not recommended due to increased leakage current from the battery when the indicator is turned off If the battery option is installed, and CPU Jumper 4 is disconnected, the indicator only turns on and off by pressing the Power key
	MANUAL	Indicator powers ON/OFF by pressing Power key
BKLGHT	OFF ON AUTO	Allows control of the LED backlight display OFF – backlight always off ON – backlight always on AUTO - backlight will turn off after the configured amount of time, if no buttons are pressed and there is no change in the weight; once either of these occurs, the backlight will turn on Auto time Options: 10 sec, 30 sec, 1 min, 5 min, 10 min
BAT	LEVEL	Allows reading the battery level in mV units NOTE: If there is not a battery option installed, NOBATT will display. When the battery is charging, CHRNG will display.

Table 3-8. MISC Menu Parameters

3.2 Configuration Using the Front Panel (Legal for Trade)

The 480 indicator can be configured using a series of menus accessed through the indicator front panel when the indicator is in configuration mode.

When the indicator is placed in configuration mode, **CONFIG** is on the display. The **CONFIG** menu is the first of eight main menus used to configure the indicator. Detailed descriptions of these menus are given in [Section 3.2.1 on page 35](#). When configuration is complete, return to **CONFIG** and press the **Zero** Δ to exit configuration mode and save changes. Replace the configuration switch access screw.

To place the indicator into the configuration mode, a configuration switch is accessed by removing the setup switch access head screw on the enclosure back, See [Figure 2-1 on page 11](#). The switch is activated by inserting a non-conductive tool into the access hole after pressing the menu switch.

1. Remove setup switch access screw from back of indicator.
2. Using a non-conductive tool, press the button located in the access hole. This allows access to configuration menus.

Menu	Required Password*	Description
CONFIG	Config	Graduations (scale capacity), configure zero tracking, zero range, motion band, overload, tare function, sample rate and digital filtering parameters
FORMAT	Config	Set primary and secondary units
CALIBR	Config	Calibrate the indicator, See Section 4.0 on page 46 for calibration procedures
PROGRM	Config	Set power-up and regulatory modes, consecutive numbering and sleep parameters
DIG IN	User	Assign digital input functions; used only if the Relay option is installed
ALGOUT	Config	Configure the analog output module; used only if analog output option is installed
PASWRD	Config	Enable and edit configuration and user passwords
USBMEM	Config	Allows the saving and loading of configuration settings from a USB flash memory device
TEST	Config	Test A/D, Test and set Digital I/O; reset indicator to default settings, set over and under weighment characteristics
MENU	User	Non Legal for Trade settings, Audit Trail, view Tare, set Unit ID, view/print Accumulator, set Time/Date, Communication Port, Setpoints and Print Format parameters, See Section 3.1 on page 24 NOTE: Can be accessed without pressing the Setup Switch, by pressing the Menu key on the front panel.

* Password required for all menus if a password for that level has been entered, See [Section 3.2.8 on page 44](#)

Table 3-9. 480 Menu Summary

3.2.1 Configuration Menu Structures and Parameter Descriptions

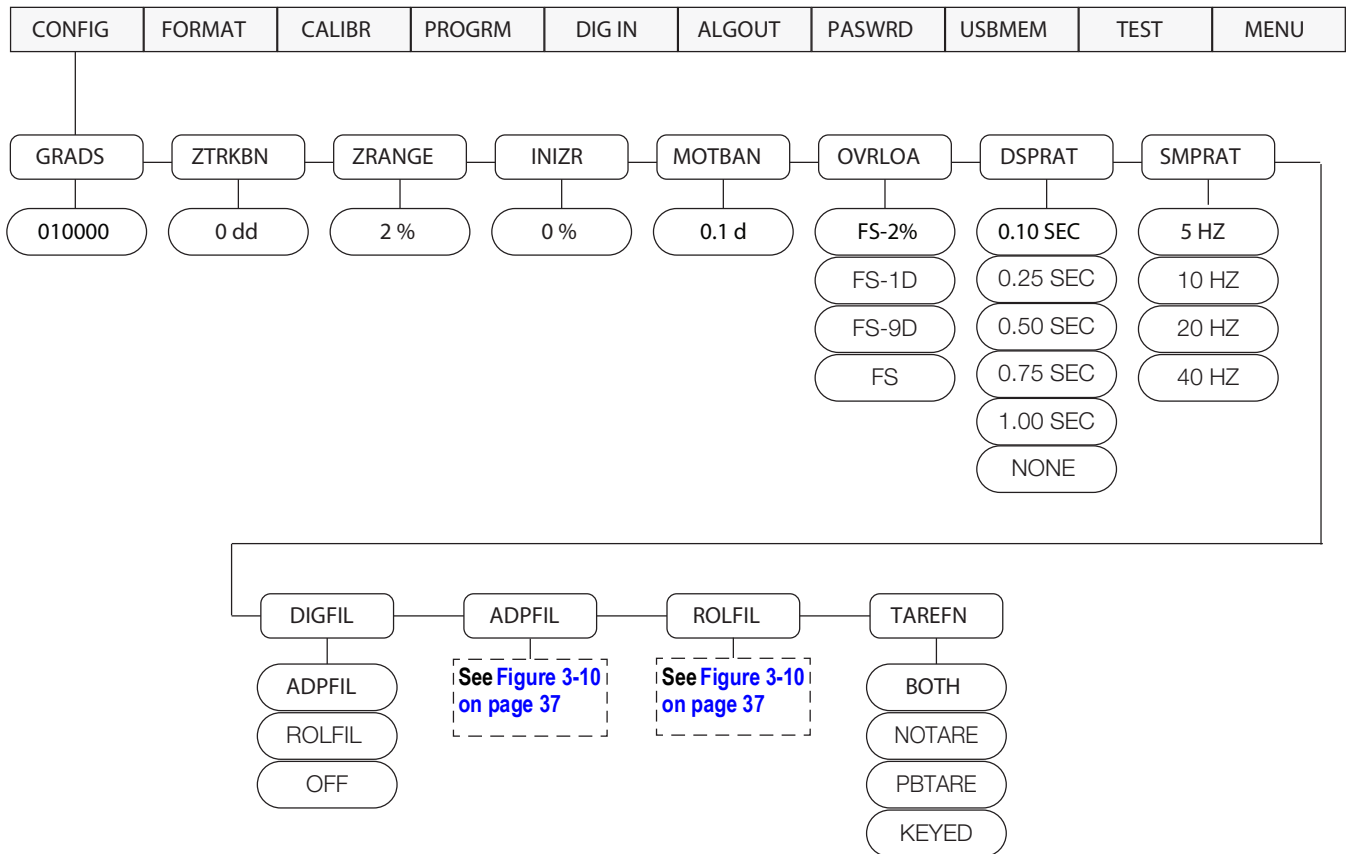

Figure 3-9. Configuration Menu

Parameter	Choices	Description
GRADS	10000 1–100000	Graduations – specifies the number of full scale graduations; the value entered must be in the range 1–100,000 and should be consistent with legal requirements and environmental limits on system resolution
ZTRKBN	0 dd 0.0–3.0dd	Zero track band – automatically zeros the scale when within the range specified, as long as the input is within the configured zero range (ZRANGE parameter); selections are ± display divisions; maximum legal value varies depending on local regulations
ZRANGE	2% 1%–100%	Zero range – selects the range within which the scale can be zeroed; the 2% selection is ± 2% around the calibrated zero point, for a total range of 4%; indicator must be at standstill to zero the scale
INIZR	0% 0–100%	Initial zero range at power up; See Error messages HINOFF and LINOFF in Section 9.1.1 on page 61 ; if on power up, the weight value is between the ±% range specified of Calibrated Zero, the indicator will zero off that weight; if outside that range, the indicator will display HINOFF or LINOFF, depending on whether the initial reading is above or below the range NOTE: If not set at zero, hopper/scale MUST be empty when powered up.
MOTBAN	0.1d 0.0d–100d	Motion band – sets the level, in display divisions, at which scale motion is detected; if motion is not detected, the standstill symbol lights; some operations, including print, tare and zero, require the scale to be at standstill; maximum legal value varies depending on local regulations NOTE: Setting the MOTBAN setting to 0.0 disables motion sensing and the scale will always be considered stable.
OVRLA	FS+2% FS+1D FS+9D FS	Overload – determines the point at which the display blanks and an out-of-range error message is displayed; maximum legal value varies depending on local regulations

Table 3-10. Configuration Menu Parameters

Parameter	Choices	Description
DSPRAT	0.1 SEC 0.25 SEC 0.5 SEC 0.75 SEC 1 SEC NONE	Display rate – sets the update rate for displayed values. Values are in seconds (SEC) No display filtering – the display is updated at up to the A/D sample rate
SMPRAT	5HZ 10HZ 20HZ 40HZ	A/D Sample rate – selects measurement rate, in samples per second, of the analog-to-digital converter; lower sample rate values provide greater signal noise immunity
DIGFIL	ADPFIL ROLFIL OFF	Adaptive Filter – selects the adaptive digital filter, See Figure 3-10 on page 37 Rolling Average Filter - selects the rolling average filter, See Figure 3-10 on page 37 OFF- Disables the digital filter See Section 9.11 on page 69 for more information on Digital Filtering
TAREFN	BOTH	Tare function – enables or disables push-button and keyed tares Both push-button and keyed tares are enabled
	NOTARE	No tare allowed (gross mode only)
	PBTARE	Push-button tare enabled
	KEYED	Keyed tare enabled

Table 3-10. Configuration Menu Parameters (Continued)

3.2.2 Adaptive Filter and Rolling Filter Sub-menu Parameters

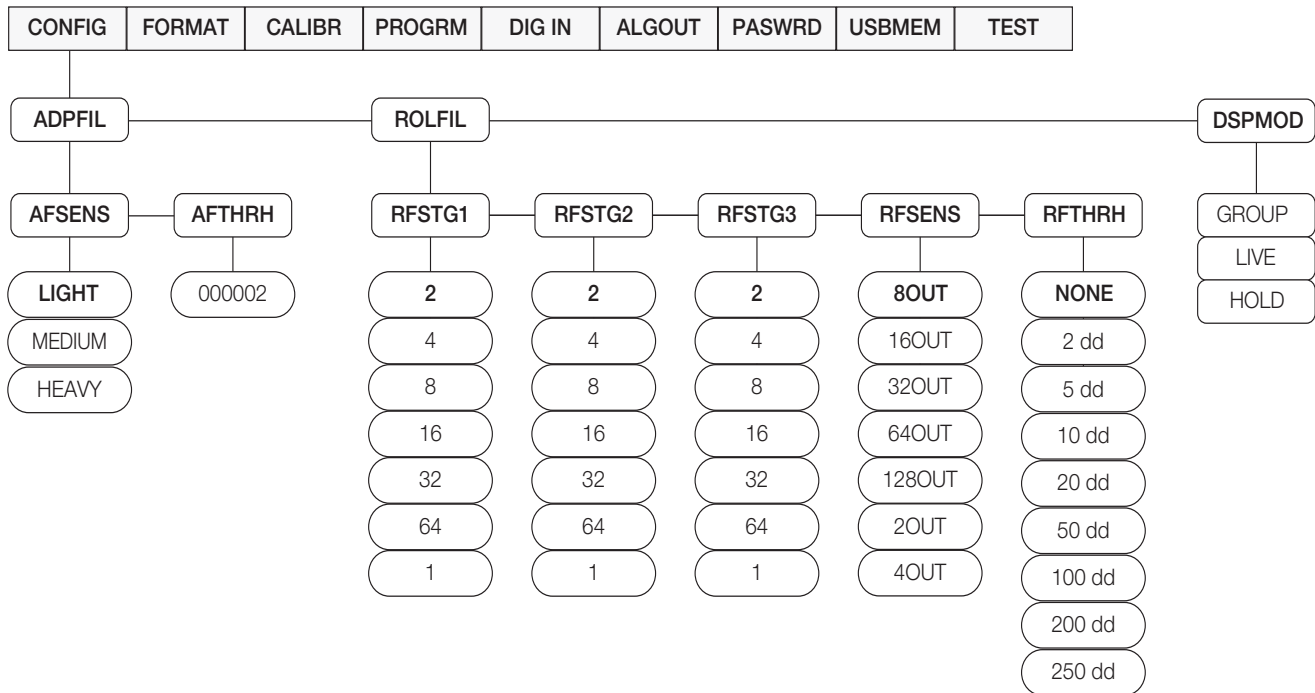

Figure 3-10. Adaptive Filter and Rolling Averaging Filter Sub-menu

Parameter	Choices	Description
ADPFIL Sub-menu		
AFSENS	LIGHT MEDIUM HEAVY	Digital filter cutout sensitivity – the light setting responds quickly to small weight changes and is less stable; the heavy setting responds slowly to small weight changes and is more stable; use the heavy setting in an unstable environment
AFTHRH	000002	Digital filter cutout threshold – specifies the filter threshold, in weight value; when a weight change exceeds the value set for threshold, digital filtering is suspended; a setting of 0 disables the filter; the decimal point in the entered value is assumed; if the dd is 1 lb, a value of 1 is equal to 1 lb; if the dd is 0.1 lb, a value of 1 is equal to 0.1 lb
ROLFIL Sub-menu		
RFSTG1 RFSTG2 RFSTG3	2, 4, 8, 16, 32, 64, 1	Rolling filter stages – the number of A/D samples that are averaged in each stage; a higher number gives a more stable display by minimizing the effect of a few noisy readings, but slows down the settling rate of the indicator, See Section 9.11 on page 69 for more information on digital filtering
RFSENS	8OUT 16OUT 32OUT 64OUT 128OUT 2OUT 4OUT	Rolling filter cutout sensitivity – specifies the number of consecutive readings that must fall outside the rolling filter threshold (RFTHRH parameter) before digital filtering is suspended; if NONE is selected, the filter is always enabled
RFTHRH	NONE 2 dd 5 dd 10 dd 20 dd 50 dd 100 dd 200 dd 250 dd	Rolling filter cutout threshold – specifies the rolling filter threshold, in display divisions; when a specified number of consecutive scale readings (RFSENS parameter) fall outside of this threshold, digital filtering is suspended; if NONE is selected, the filter is always enabled

Table 3-11. Adaptive Filter and Rolling Filter Submenu Parameters

3.2.3 Format Menu

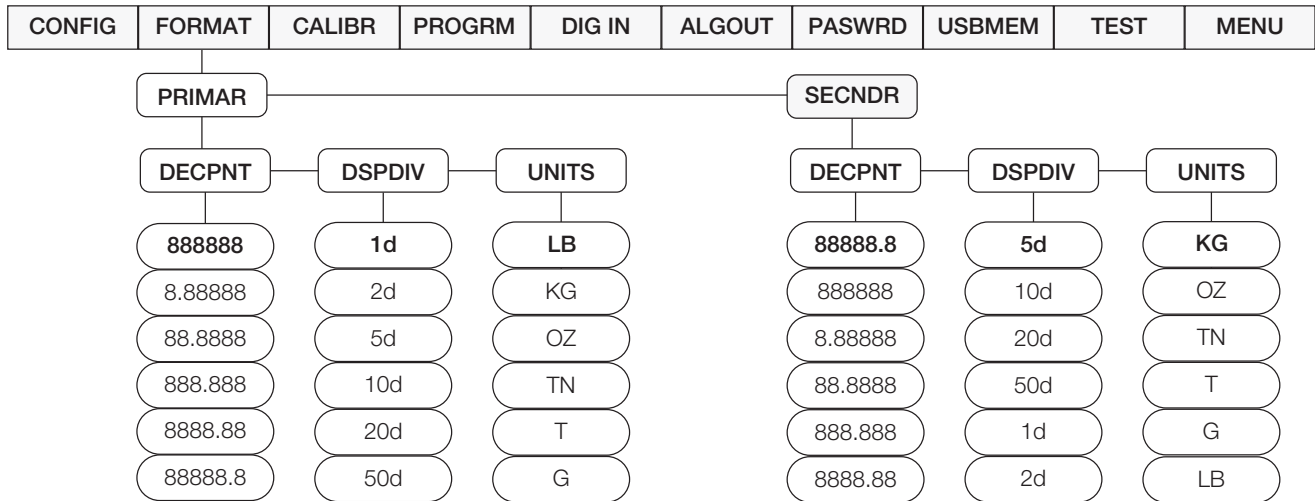

Figure 3-11. Format Menu

Parameter	Choices	Description
PRIMAR SECNDR	DECPNT DSPDIV UNITS	Primary Units – specifies the capacity, decimal position, display divisions, and units used Secondary Units – specifies the capacity, decimal position, display divisions, units and conversion multiplier used, See Sub-menu parameters below for descriptions
Sub-menus		
DECPNT	888888 8.88888 88.8888 888.888 8888.88 88888.8	Decimal point location – specifies the location of the decimal point in the primary unit display; value should be consistent with local legal requirements Primary default – 888888 Secondary default – 88888.8
DSPDIV	1 2 5 10 20 50	Enter divisions (external) in primary units – scale resolution will be determined by the formula CAP / DIV = Resolution Primary default – 1 Secondary default – 5
UNITS	lb kg OZ TN T G	Specifies primary units for displayed and printed weight. Values are: lb = pound; kg = kilogram; OZ = ounce; TN = short ton; T = metric ton; G = gram Primary default – lb Secondary default – kg NOTE: Indicators sold outside North America are configured with kg for both primary and secondary units.

Table 3-12. Format Menu Parameters

3.2.4 Calibration Menu

See [Section 4.0 on page 46](#) for Calibration procedures.

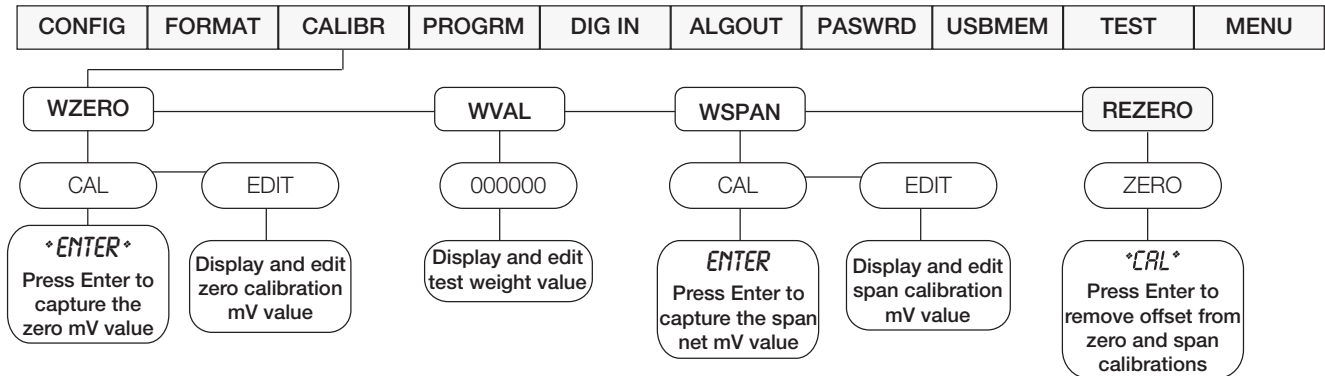

Figure 3-12. Calibration Menu



Note *EDIT is the current calibrated value that can be edited.*

Parameter	Choices	Description
WZERO	CAL	Do not adjust this value after WSPAN has been set; press ∇ to display ENTER then press \leftarrow to capture the zero value
	EDIT	Press ∇ to display the current captured zero mV value; the value may be edited as required; press \leftarrow to save the edited value
WVAL	Number	Press ENTER to display and edit the test weight value
WSPAN	CAL	Press ∇ to display ENTER then press \leftarrow to capture the net span value
	EDIT	Press ∇ to display the current captured net span mV value; the value may be edited as required; press \leftarrow to save the edited value
REZERO	ZERO (flashing)	Press \leftarrow to remove the weight of the testing apparatus like hooks or chains used during the calibration process; always use this parameter after WZERO and WSPAN have been set to recapture a new zero value, See Section 4.1 on page 46 for more information about using this parameter

Table 3-13. Calibration Menu Parameters

3.2.5 Program Menu

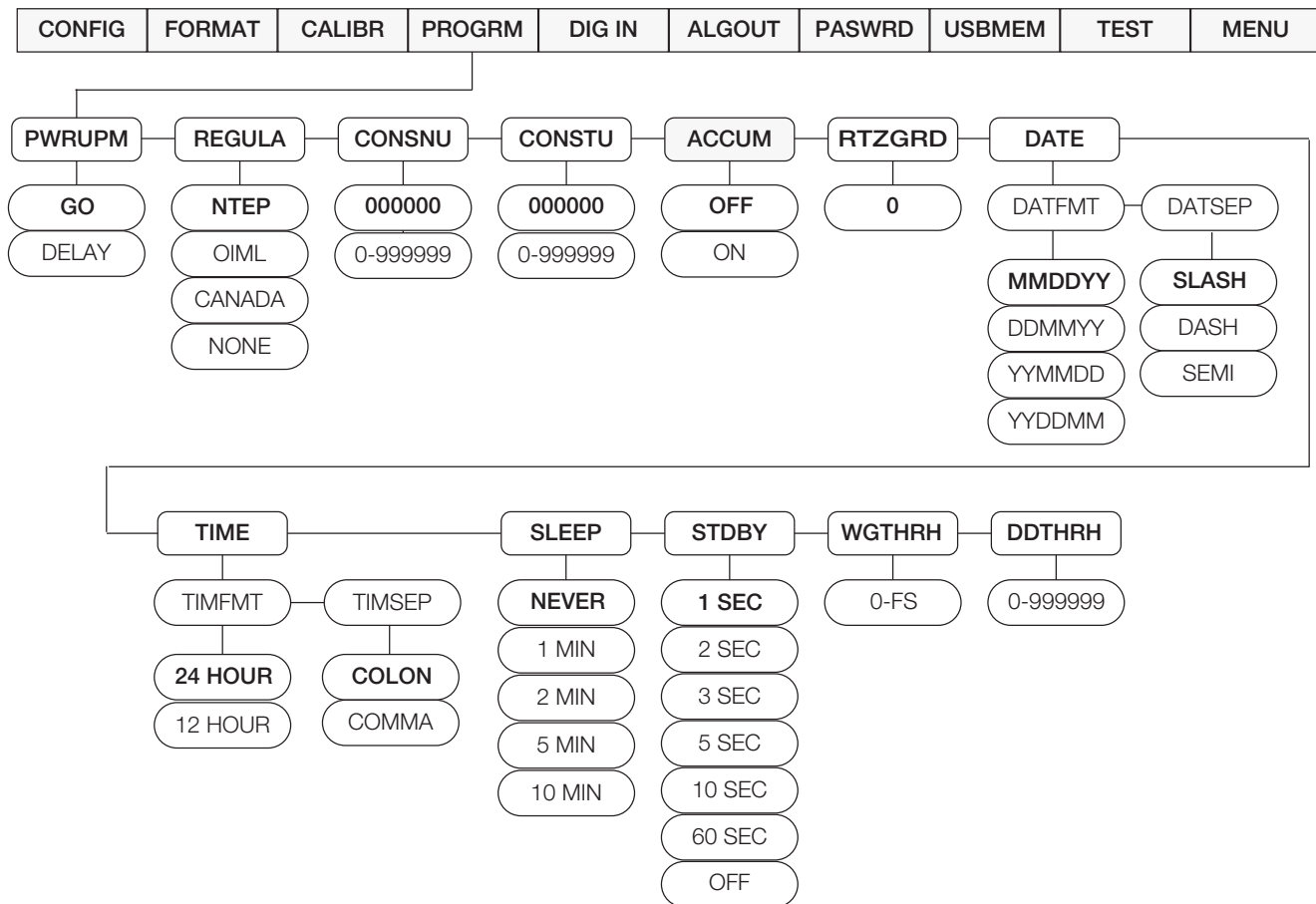

Figure 3-13. Program Menu

Parameter	Choices	Description
PWRUPM	GO DELAY	Power up mode – in GO mode, the indicator goes into operation immediately after a brief power up display test; in DELAY mode, the indicator performs a power up display test and then enters a 30 second warm-up period; if no motion is detected during the warm-up period, the indicator becomes operational when the warm-up period ends; if motion is detected, the delay timer is reset and the warm-up period repeated
REGULA	NTEP OIML CANADA NONE	Regulatory mode – specifies the regulatory agency having jurisdiction over the scale site; OIML, NTEP, and CANADA modes allow a tare to be acquired at a weight greater than zero; NONE allows tares to be acquired at another weight value; OIML, NTEP, and CANADA modes allow a tare to be cleared only if the gross weight is at no load; NONE allows tares to be cleared at another weight value; NTEP and OIML modes allow a new tare to be acquired even if a tare is already present; in CANADA mode, the previous tare must be cleared before a new tare can be acquired; NONE, NTEP and CANADA modes allow the scale to be zeroed in either gross or net mode as long as the current weight is within the specified ZRANGE; in OIML mode, the scale must be in gross mode before it can be zeroed; pressing the Zero key in net mode clears the tare
CONSNU	000000 0-999999	Consecutive numbering – allows sequential numbering for print operations; the consecutive number value will increment following each print operation when the print format used contains the <CN>, or consecutive number formatting token; this value is read only NOTE: The initial value of this parameter is set to the start up value specified on the CONSTU parameter. Changing CONSTU immediately resets the consecutive number used for printing.

Table 3-14. Program Menu Parameters

Parameter	Choices	Description
CONSTU	000000 0-999999	Consecutive number start up value – specifies the initial consecutive number (CONSNU) value used when the indicator is reset or configured NOTE: Consecutive numbering starts with number entered. <i>Example: If 100 is entered the first ticketed printed will be 100</i>
ACCUM	OFF ON	Turns the accumulator on and off; stores the accumulated weight, time and date of last accumulation
RTZGRD	0 0-999999	Return to zero grads to re-arm the accumulator; default = 0 Defines the number of graduations from Zero that the weight has to go below before the accumulator will be re-armed
DATE	DATFMT DATSEP	Allows selection of date format and date separator, See Date sub-menu for parameter descriptions
TIME	TIMFMT TIMSEP	Allows selection of time format and separator, See Time sub-menu for parameter descriptions
SLEEP	NEVER 1MIN 2MIN 5MIN 10MIN	Sleep mode; When weight is stable, no buttons have been pressed, and the weight is below the sleep weight threshold (WGTHRH), the indicator will enter the sleep mode in the time defined in the SLEEP Parameter; a NEVER setting will disable the sleep mode, See Section 9.6 on page 66 NOTE: The SLEEP mode will only operate if the indicator is operating on Internal Battery Power - disconnected from AC power. Setting the WGTHRH or DDTHRH parameters to 0 also disables sleep mode
STDBY	1SEC 5SEC 10SEC 15SEC 30SEC 60SEC OFF	Controls the Standby mode; when in the sleep mode, at the number of seconds set in STDBY, the indicator will wake if: <ul style="list-style-type: none"> • There is weight on the scale of more than the WGTHRH value • The weight has is changed greater than DDTHRH value • It detects that a button is being pressed
WGTHRH	0 – FS (primary units)	Controls the Weight Threshold of the Sleep Mode: <ul style="list-style-type: none"> • If the weight is above WGTHRH, the indicator will not go into sleep mode • If the weight is below WGTHRH, it will go into sleep mode if the weight remains stable and no buttons are pressed, for the time set in the Sleep mode parameter
DDTHRH	999999 (in divisions)	Controls the weight change detection feature of Sleep mode, once the indicator detects that the weight level on the scale is changed more than DDTHRH it will wake up
DATE sub-menus		
DATFMT	MMDDYY DDMMYY YYMMDD YYDDMM	Specifies the format used to display or print the date
DATSEP	SLASH DASH SEMI	Specifies the date separator character
TIME sub-menus		
TIMFMT	24HOUR 12HOUR	Specifies the format used to display or print the time
TIMSEP	COLON COMMA	Specifies the time separator character

Table 3-14. Program Menu Parameters (Continued)

3.2.6 Digital Input Menu

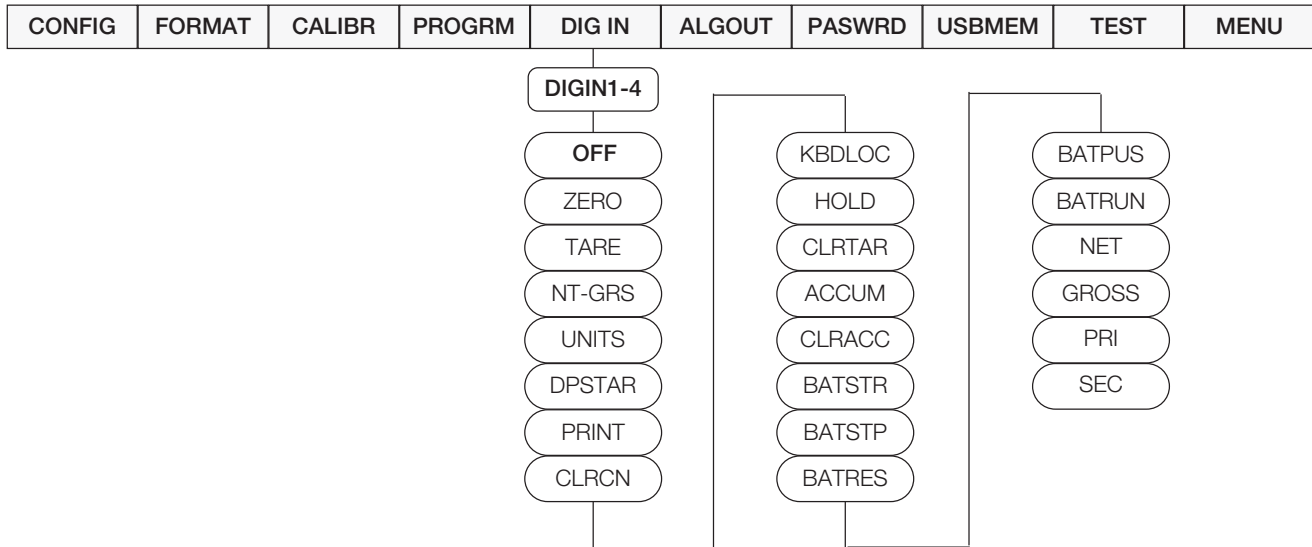

Figure 3-14. Digital Input Menu

Parameter	Choices	Description
DIGIN1	--	Specifies the function activated by digital inputs 1, 2, 3 and 4
DIGIN2	OFF	Sets the Digital Input to perform no function
DIGIN3	ZERO	Same function as the front panel key
DIGIN4	TARE	Same function as the front panel key
	NT-GRS	Net-Gross – same function as the front panel key
	UNITS	Same function as the front panel key
	DSPTAR	Displays the current tare value
	PRINT	Same function as the front panel key
	CLRCN	Resets the consecutive number to the value specified on the CONSTU parameter (PROGRM menu)
	KBDLOC	Disables the keypad while the digital input is held active
	HOLD	Holds the current display; releasing this input returns to normal display update mode
	CLRTAR	Clears the tare
	ACCUM	Displays the accumulator
	CLRACC	Clears the accumulator
	BATSTR	Starts a batch process
	BATSTP	Stops a batch; a restart starts the batch at the beginning
	BATRES	Resets the batch process; the pointers are aimed at first batching setpoint
	BATPUS	Pauses a batch, but allows it to restart at the point where it was paused
	BATRUN	A switch that allows a batch to be started. It must be active to allow a batch to run; if not active, and a BATSTRT input is activated, the batch will abort or reset
	NET	Puts the scale in net mode
	GROSS	Puts the scale in gross mode
	PRI	Puts the scale in primary units
	SEC	Puts the scale in secondary units

Table 3-15. Digital Input Menu Parameters

3.2.7 Analog Output Menu

If the analog output option is installed, configure all other indicator functions and calibrate the indicator, See [Section 4.0 on page 46](#) before configuring the analog output, See [Section 9.12 on page 71](#) for analog output calibration procedures.

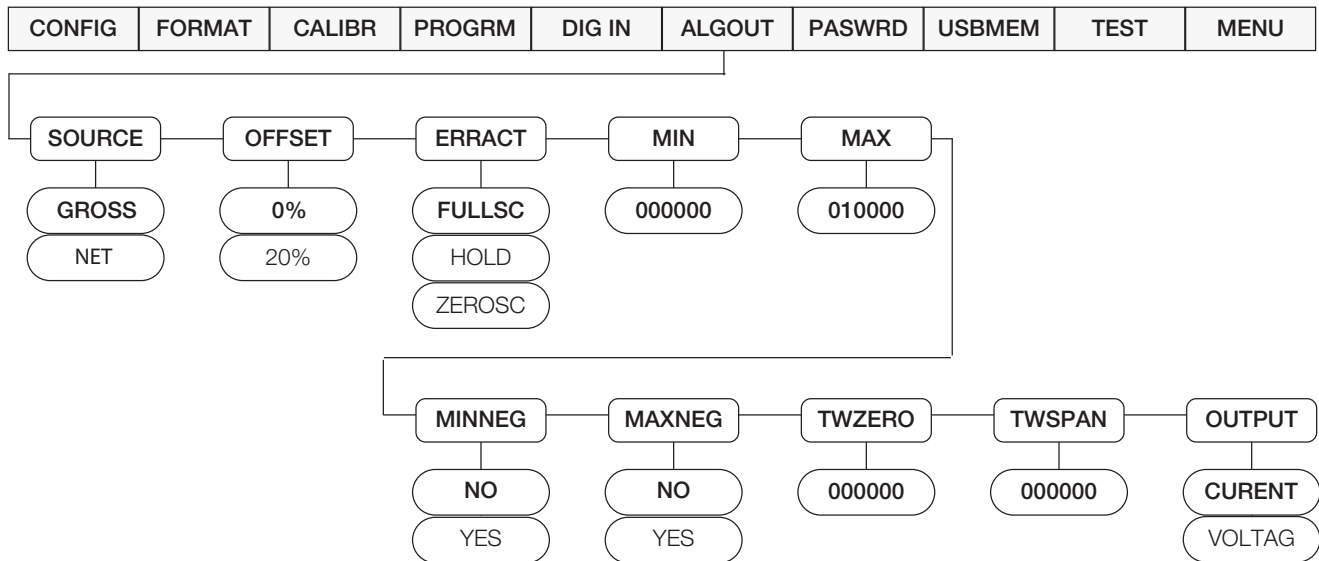

Figure 3-15. Analog Output Menu

Parameter	Choices	Description
SOURCE	GROSS NET	Specifies the weigh data, gross or net, tracked by the analog output
OFFSET	0 20	Zero offset in %; select 0% for 0–10 V / 0–20 mA; select 20% for 2–10 V / 4–20 mA output
ERRACT	FULLSC	Error action. Specifies how the analog output responds to system error conditions Set to full value (10 V or 20 mA)
	HOLD	Hold current value
	ZEROSC	Set to zero value (0 V or 0 mA) or (2 V or 4 mA)
MIN	000000 0–999999	Specifies the minimum weight value tracked by the analog output; specify a weight value (in primary units) in the range 0–999999
MAX	010000 0–999999	Specifies the maximum weight value tracked by the analog output; specify a weight value (in primary units) in the range 0–999999
MINNEG	NO Yes	YES implies that the value in MIN is a negative value; NO is the default and implies that MIN is a positive value
MAXNEG	NO Yes	YES implies that the value in MAX is a negative value; NO is the default and implies that MAX is a positive value
TWZERO	000000 0–65535	Tweak zero – adjust the analog output zero calibration; use a multimeter to monitor the analog output value; press ◀ or ▶ to select the digit to edit; press ▲ or ▼ to edit the selected (flashing) digit; press ↵ to save the new value
TWSPAN	000000 0–65535	Tweak span – adjust the analog output span calibration; use a multimeter to monitor the analog output value; press ◀ or ▶ to select the digit to edit; press ▲ or ▼ to edit the selected (flashing) digit; press ↵ to save the new value
OUTPUT	CURENT	Defines the output type 0–20 mA or 4–20 mA, depends on OFFSET
	VOLTAG	0–10 V or 2–10 V, depends on OFFSET

Table 3-16. Analog Output Menu Parameters

3.2.8 Password Menu

The PASSW menu is used to edit or set passwords.

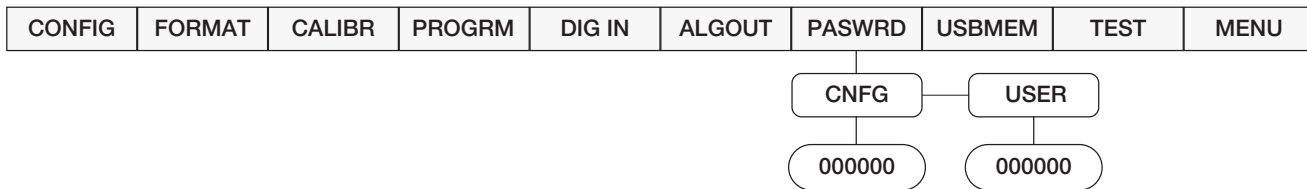

Figure 3-16. Password Menu

Parameter	Choices	Description
CNFG	0 0-999998	Edit configuration password; 0 = no password NOTE: If enabled, the configuration password is used for electronic sealing of the indicator. When configuration password has been entered, the existing configuration password is required to edit. Entering this menu requires the setup switch to be pressed.
USER	0 0-999998	Edit user password; 0 = no password NOTE: If enabled, the user password restricts access to the setpoint, serial and print formatting menus. Once a user password has been entered, the existing user password is required to edit parameters.

Table 3-17. Password Menu Parameters

IMPORTANT

Enter 999999 to reset the password, this will also reset the configuration back to default values.

3.2.9 USBMEM Menu

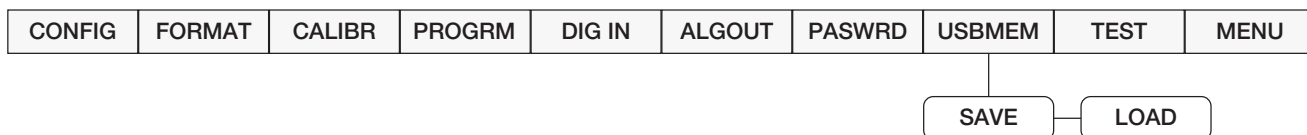

Figure 3-17. USBMEM Menu

Parameter	Choices	Description
SAVE	--	Save the configuration parameters to a file on a flash drive
LOAD	--	Load the configuration parameters from a file on a flash drive

Table 3-18. USBMEM Menu Parameters



Note For more information on using a flash drive to load and save configuration settings, See [Section 9.8 on page 67](#).

3.2.10 Test Menu



Note Access to this menu requires the configuration password, if it has been enabled.

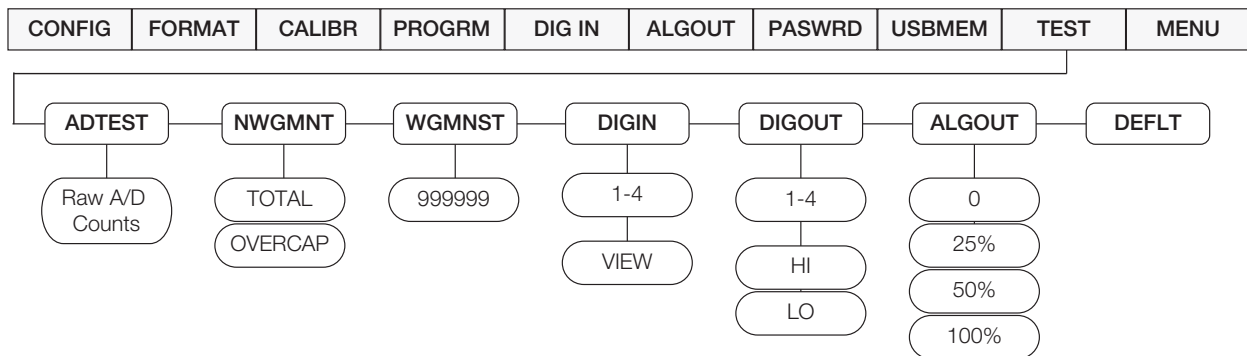

Figure 3-18. Test Menu



Digital output relay test.

HI = Active = ON

LO = Inactive = OFF

Parameter	Choices	Description
ADTEST	--	Displays raw A/D counts
NWGMNT	TOTAL	The number of weighments that exceed value set in WGMNST
	OVECAP	The number of weighments that exceed the capacity of the scale as set in the config and format menus, See Table 3-17 on page 44 and Table 3-19
WGMNST	0-999999	Weighment Threshold – sets the weight threshold over which WGMNST/Over value will be counted
DIGIN	1-4	Access to display status. Allows selection of each Digital Input to display its current state, HI or LO NOTE: If the setting cannot be viewed, that option is not installed.
	VIEW	
DIGOUT	1-8	Access to each of the Digital Output and to manually set them individually to HI or LO, HI is active NOTE: If the setting cannot be viewed, that option is not installed.
	HI	
	LO	
ALGOUT	0	Allows analog output to be manually set to certain output values for calibration and test of external equipment NOTE: The analog output must NOT be in an error state as that will override these settings. If the setting cannot be viewed, that option is not installed.
	25%	
	50%	
	100%	
DEFLT	--	Resets all parameters to factory defaults; at DEFLT, press GROSS/NET, indicator will display SAVING and cycle power

Table 3-19. Test Menu Parameters

3.2.11 User Menu Setup

See [Section 3.1 on page 24](#) for information about User Menu Setup.

3.3 Revolution Configuration

The Revolution configuration utility provides another method for configuring the 480 indicator. Revolution runs on a computer to set configuration parameters for the indicator. When Revolution configuration is complete, configuration data is downloaded to the indicator. Revolution supports both uploading and downloading of indicator configuration data. This capability allows configuration data to be retrieved from one indicator, edited and then downloaded to another indicator with an identical hardware configuration, See [Section 4.3 on page 48](#) and [Section 5.0 on page 49](#) for more information about using Revolution.

4.0 Calibration

The 480 can be calibrated using the front panel or the Revolution configuration utility. Each method consists of the following steps:

- Zero calibration
- Entering the test weight value
- Span calibration
- Optional rezero calibration for test weights using hooks or chains

The following sections describe the calibration procedure for each of the calibration methods.

4.1 Front Panel Calibration

The **CALIBR** sub-menu is used to calibrate the 480, See [Section 3.2.4 on page 39](#) for the calibration menu structure and parameter descriptions. To calibrate the indicator using the front panel:

1. Remove the setup switch access screw from the back of the enclosure.
2. Insert a non-conductive tool into the access hole and press the configuration switch. Indicator display changes to **CONFIG**, See [Figure 2-1 on page 11](#).
3. Press \triangleright until **CALIBR** is displayed.
4. Remove all weight from the scale platform. If the test weights require hooks or chains, place the hooks or chains on the scale for zero calibration.
5. Press ∇ to **WZERO**.
6. Press ∇ to **CAL**.
7. Press ∇ to **ENTER**.
8. Press \leftarrow to calibrate zero. The indicator displays ***CAL*** while calibration is in progress. When complete, the mV value for the zero calibration is displayed.
9. Press \triangle to save the zero calibration value and go to **CAL**.
10. Press \triangle to **WZERO**.
11. Press \triangleright to **WVAL**.
12. Press ∇ to display the test weight value.
13. Press ∇ to edit value using the procedure in [Section 1.7 on page 5](#) to enter the actual value of the test weights to be used for the span calibration. Press \leftarrow to store the entered **WVAL** value.
14. Press \triangle to **WVAL**.
15. Press \triangleright to **WSPAN**.
16. Press ∇ to **CAL**.
17. Press ∇ to **ENTER**.
18. Place test weights on the scale and press \leftarrow to calibrate span. The indicator displays ***CAL*** while calibration is in progress. When complete, the net millivolt value of the test weight for the span calibration is displayed.



Note *Net mV value is equal to the raw mV value at the span minus the mV value captured for zero.*

19. Press \triangle to save value and go to **CAL**.
20. Press \triangle to **WSPAN**. If using chains or hooks for test weights, proceed with [Step 21](#). If no chains or hooks were used, proceed with [Step 23](#).
21. Press \triangleright to **REZERO**. The **REZERO** function is used to remove a calibration offset when hooks or chains are used to hang the test weights.

22. Remove the hooks or chains used during calibration and remove the test weights from the scale. Press ▾. **ZERO** will display briefly. With all weight removed, press ◀ to rezero the scale. This function adjusts the zero and span calibration values. The indicator displays ***CAL*** while the zero and span calibrations are adjusted.
23. Press ▲ to return to the CALIBR menu.
24. Remove all weight from the scale. Press ◀ until the display reads **CONFIG**. Press ▲ to exit configuration mode.

4.2 EDP Command Calibration

To calibrate the indicator using EDP commands, the indicator COM 1 port must be connected to a terminal or computer, See [Section 6.0 on page 51](#) for more information about using EDP commands.

Once the indicator is connected to the sending device, use the following steps:

1. Place the indicator in configuration mode (display reads **CONFIG**) and remove all weight from the scale platform. If test weights require hooks or chains, place them on the scale for zero calibration.
2. Send the SC.WZERO EDP command to calibrate zero. The indicator displays ***CAL*** while calibration is in progress.
3. Place test weights on the scale and use the SC.WVAL command to enter the test weight value in the following format:
Example: WVAL=nnnnnn<CR>
4. Send the SC.WSPAN EDP command to calibrate span. The indicator displays ***CAL*** while calibration is in progress.
5. To remove an offset value, clear all weight from the scale, including items used to hang test weights, and then send the SC.REZERO EDP command. The indicator displays ***CAL*** while the zero and span calibrations are adjusted.
6. Send the KUPARROW EDP command to exit configuration mode.

4.3 Revolution Calibration

To calibrate the indicator using Revolution, the indicator COM 1 port must be connected to a PC running the Revolution configuration utility.

Use the following procedure to calibrate the indicator:

1. Select **Calibration Wizard** from the Revolution tools menu.
2. Revolution uploads calibration data from the indicator and presents the information in the calibration wizard, see [Figure 4-1](#) for more information.



Figure 4-1. Revolution Calibration Display

3. Enter the **Value of Test Weight** to be used for span calibration and click **OK**.
4. The zero calibration dialog box prompts to remove all weight from the scale. Clear the scale and click **OK** to begin zero calibration.



Note *If test weights require hooks or chains, place them on the scale for zero calibration.*

5. When zero calibration is complete, the span calibration dialog box prompts to place test weights on the scale for span calibration. Place test weights on the scale and click **OK**.
6. When calibration is complete, the **New Settings** fields of the indicator calibration display are filled in. Click **Exit** to save the new values and return to the Revolution main menu; to restore the previous calibration values, click **Restore Settings**.

4.4 More About Calibration

The following provides additional information about **WVAL** and how to manually tweak a calibration up or down.

WVAL

When a WVAL number is entered that uses a decimal point, the value will be rounded when displayed.

Example: A precision value such as 2455.23 is entered by the operator, but when the operator returns to the WVAL display, the number is rounded to 2455. A higher precision value can be entered for WVAL when the display division is greater than 1, such as X2, X5 or X10.

Millivolt Values

Zero is the dead weight millivolt value and **Span** is the test weight millivolt value. The total millivolts equals **Zero + Span**.

4.4.1 Adjusting Final Calibration

Calibration may be affected by environmental factors including wind, vibration and angular loading.

Example: A strain test may determine that at 2000 lb the calibration is 2 lb high. In this case, final calibration can be tweaked by changing WVAL to 999 lb. This adjustment provides a linear correction of 1 lb per 1000 lb.

To adjust the final calibration, return to the **WVAL** prompt and press **←** to display the test weight value. Press **△** or **▽** to adjust calibration up or down. Press **↵** to save the value. Press **△** to return to the CALIBR menu.

5.0 Revolution®

The Revolution® utility provides a suite of functions used to support configuration, calibration, customization and backup of the 480 software.

Calibration values and scale configuration can both be saved and restored to the 480 using Revolution.

Hardware and Software Requirements

- Minimum system requirements: 166 MHz, x86-compatible, with 32 MB RAM (64 MB for NT4/2000/XP), 40 MB disk space
- Recommended system: 233 MHz, x86-compatible or greater, with 64 MB RAM, 300 MB disk space

Revolution runs on most Windows® operating systems, including Windows Vista SP2, Windows 7 SP1, Windows 8.1 and Windows 10 (both 32-bit and 64-bit architectures are supported).

System requirements to run Revolution are as follows:

- 1 GHz CPU (x86-32-bit or x86-64-bit)
- 512 MB RAM
- 850 MB disk space (32-bit) or 2 GB disk space (64-bit)

5.1 Connecting to the Indicator

Connect the PC serial port to com 1 of the 480 then select **Connect** in the toolbar. Revolution attempts to establish communications to the indicator. If communications settings need to be adjusted, select **Options...** from the Tools menu.

Downloading to the Indicator

The Download Configuration function on the Revolution Communications menu allows a Revolution configuration file (with or without scale calibration data) or ticket formats to be downloaded to a connected indicator in configuration mode.

The Download Section function on the Communications menu allows the download of only the currently displayed object, such as a scale configuration.

Because less data is transferred using the Download Section, it is typically faster than a full configuration download, but there is an increased possibility that the download may fail due to dependencies on other objects. If the download fails, try performing a complete download using the Download Configuration function.

Uploading Configuration to Revolution

The Upload Configuration function on the Revolution Communications menu allows the existing configuration of a connected indicator to be saved to a file on the PC. Once saved, the configuration file provides a backup that can be quickly restored to the indicator if needed. Alternatively, the file can be edited within Revolution and downloaded back to the indicator.

5.2 Saving and Transferring Data



Note *Revolution has a module to save and transfer data. It is the preferred method over using ProComm or Hyper Terminal.*

5.2.1 Saving Indicator Data to a Computer

Configuration data can be saved to a computer connected to the selected port. The computer must be running a communications program such as PROCOMMPLUS®.

When configuring the indicator, ensure that the values set for the baud and bits parameters on the serial menu match the baud rate, bits and parity settings configured for the serial port on the computer.

To save all configuration data, first put the communications program into data capture mode then place the indicator in configuration mode and send the DUMPALL command to the indicator. The 480 responds by sending all configuration parameters to the computer as ASCII-formatted text.

5.2.2 Downloading Configuration Data from PC to Indicator

Configuration data saved on a PC or disc can be downloaded from the PC to an indicator. This procedure is useful when a number of indicators with similar configurations are set up or when an indicator is replaced.

To download configuration data, connect the PC to the selected port as described in [Section 5.2.1](#). Place the indicator in configuration mode and use the PC communications software to send the saved configuration data to the indicator. When transfer is complete, calibrate the indicator as described in [Section 4.0 on page 46](#).

5.3 Reflash Indicator

The 480 flash loader program must be downloaded on the PC being used.



Note *Reflash cable (PN 165379) is required for this process.*

5.3.1 480 Legend Series Flash Loader

1. Download the 480 Legend Series Flash Loader file from the website at: www.ricelake.com
2. Save the file to a PC or select open from the pop-up.
3. Open the program. An open file box will display.
4. Select **RUN**. The license agreement box will display.
5. Check the box to accept the license. A box will display the installation status.
6. When installation is complete, select **FINISH**.

5.3.2 480 Legend Series Firmware Update

1. Download the latest firmware .hex file to a PC from: www.ricelake.com
2. Remove the back of the indicator, See [Section 2.2 on page 11](#).
3. Connect the flash cable (PN 165379) between the PC and the indicator by plugging into J14 on the CPU board.



Note *If there are option cards in place, they will need to be removed to gain access to the CPU board connection. See [Section 2.7 on page 17](#).*

Ensure the cable is plugged in correctly, otherwise the reflash will not work. The indicator display will shut down when the flash cable is plugged in.

4. Open the program.
5. Select the serial port the 480 is connected to on the PC.
6. Navigate to the .hex file needed to be loaded.
7. Click the **Load** key in the program to start the reflash.

6.0 EDP Commands



Note *EDP commands are case sensitive. Commands must be entered in upper case.*

The 480 indicator can be controlled by a computer or remote keyboard connected to one of the indicator's communication ports. Control is provided by a set of EDP commands that can simulate front panel key press functions, display and change setup parameters, and perform reporting functions. This section describes the EDP command set.

6.1 The EDP Command Set

The EDP command set can be divided into five groups: key press commands, reporting commands, the RESETCONFIGURATION special function command, parameter setting commands, and transmit weight data commands.

When the indicator processes an EDP command, it responds 480 with the message **OK**. The **OK** response verifies that the command was received and has been executed. If the command is unrecognized or cannot be executed, the indicator responds with **??**.

The following sections list the commands and command syntax used for each of these groups.

6.1.1 Key Press Commands

Key press EDP commands, See [Table 6-1](#), simulate pressing the keys on the front panel of the indicator. Most commands can be used in both setup and weighing mode. Several of the commands serve as pseudo keys, providing functions that are not represented by a key on the front panel.

For example, to enter a 15 pound tare weight using EDP commands:

1. Type K1 and press **Enter** (or **Return**).
2. Type K5 and press **Enter**.
3. Type KTARE and press **Enter**. The display shifts to net mode when the tare is entered.

Command	Function
KZERO	In normal mode, press the Zero key
KGROSSNET	In normal mode, press the Gross/Net key
KGROSS	Goes to gross mode
KNET	Goes to net mode
KTARE	Presses the Tare key
KUNITS	In weighing mode, press the Unit key
KPRIM	Goes to primary units
KSEC	Goes to secondary units
KPRINT	In normal mode, press the Print key
KDISPACCUM	Displays current accumulator value
KCLRACCUM	Clears accumulator
KDISPTARE	Displays tare
KMENU	Presses the Menu key
KCLRCN	Resets consecutive number
KCLRTAR	Clears tare from system
KLEFTARROW	In setup mode, move left in the menu
KRIGHTARROW	In setup mode, move right in the menu
KUPARROW	In setup mode, move up in the menu
KDOWNARROW	In setup mode, move down in the menu
KSAVE	In setup mode, saves the current configuration. Command works only if a parameter has been changed
KLOCK	Locks specified front panel key; for example, to lock the Zero key, enter KLOCK=KZERO
KUNLOCK	Unlock specified front panel key; for example, to unlock the Print key, enter KUNLOCK=KPRINT
KCLR	Presses the Clear key
KDATE	Displays the date
KTIME	Displays the time
KTIMEDATE	Displays the time and date

Table 6-1. Serial Key Press Commands

6.1.2 Reporting Commands

See [Table 6-2](#) to send specific information to the selected port. These commands can be used in both setup mode and weigh mode.

Command	Function
DUMPALL	Lists all parameter values
DUMPAUDIT	Lists audit data information
P	Writes current displayed weight with units identifier, See Section 9.2 on page 63 for more information
ZZ	Writes current weight and annunciator status, See Section 9.2 on page 63 for more information
S	Writes one frame of stream format
VERSION	Returns the currently installed firmware version

Table 6-2. EDP Reporting Commands

6.1.3 The RESETCONFIGURATION Command

The RESETCONFIGURATION command can be used to restore all configuration parameters to their default values. Before issuing this command, the indicator must be placed in configuration mode.

This command is equivalent to using the DEFLT function on the TEST menu, See [Section 9.1.2 on page 62](#) for more information about test mode and using the TEST menu.



Note All load cell calibration settings are lost when the RESETCONFIGURATION command is run.

6.1.4 Parameter Setting Commands

Parameter setting commands allow the display or change the current value for a particular configuration parameter.

Current configuration parameter settings can be displayed in either setup mode or weigh mode using the following syntax:

Example: command<ENTER>

Most parameter values can be changed in setup mode only; setpoint parameters listed in [Table 6-10 on page 55](#) can be changed when in weigh mode.

Use the following command syntax when changing parameter values: `command=value<ENTER>`, where value is either a number or a parameter value. Use no spaces before or after the equal (=) sign. If an incorrect command is typed, the display reads ??.

6.1.5 Soft Reset

The command RS will reset the indicator without losing configuration and calibration. It does reset consecutive number and count mode.

Command	Description	Values
SC.GRADS	Graduations	1-100000
SC.ZTRKBND	Zero track band	0.0-3.0
SC.ZRANGE	Zero range	1 - 100 <i>Example: to make it 5%, enter "SC.ZRANGE=5")</i>
SC.INIZR	Initial zero range	0-100 (if set to zero, no initial zero is performed)
SC.MOTBAND	Motion band	0.0 - 100 (in display divisions) <i>Example: to enter 5 divisions, send "SC.MOTBAND=5.0"</i>
SC.OVRLOAD	Overload	FS+2%, FS+1D, FS+9D, FS
SC.DSPRAT	Display Rate	0.1 SEC, 0.25 SEC, 0.5 SEC, 0.75 SEC, 1 SEC, NONE
SC.SMPRAT	Sample rate	5HZ, 40HZ, 20HZ, 10HZ
SC.DIGFIL	Select Digital Filter Type	ADAPTIVE, ROLLING, OFF
SC.AFILTER.SENSITIVITY	Adaptive digital filter cutout sensitivity	LIGHT, MEDIUM, HEAVY
SC.AFILTER.THRESHOLD	Adaptive digital filter cutout threshold	0-999999
SC.RFILTER.SENSITIVITY	Digital filter cutout sensitivity	2OUT, 4OUT, 8OUT, 16OUT, 32OUT, 64OUT, 128OUT
SC.RFILTER.THRESHOLD	Digital filter cutout threshold	NONE, 2DD, 5DD, 10DD, 20DD, 50DD, 100DD, 200DD, 250DD
SC.RFILTER.STAGE1-3	Digital filtering	1, 2, 4, 8, 16, 32, 64
SC.TAREFN	Tare function	BOTH, NOTARE, PBTARE, KEYED

Table 6-3. CONFIG EDP Commands

Command	Description	Values
SC.PRI.DECPNT	Primary units decimal position	8.88888, 88.8888, 888.888, 8888.88, 88888.8, 888888
SC.PRI.DSPDIV	Primary units display divisions	1D, 2D, 5D, 10D, 20D, 50D
SC.PRI.UNITS	Primary units	LB, KG, OZ, TN, T, G
SC.SEC.DECPNT	Secondary units decimal position	8.88888, 88.8888, 888.888, 8888.88, 88888.8, 888888
SC.SEC.DSPDIV	Secondary units display divisions	1D, 2D, 5D, 10D, 20D, 50D
SC.SEC.UNITS	Secondary units	LB, KG, OZ, TN, T, G

Table 6-4. FORMAT EDP Commands

Command	Description	Values
SC.WZERO	Zero calibration	—
SC.WVAL	Test weight value	Value
SC.WSPAN	Span calibration	—
SC.REZERO	Rezero	—
SC.LC.CD	Read or set dead load counts	Value
SC.LC.CW	Read or set span counts	Value

Table 6-5. CALIBR EDP Commands

Command	Description	Values
PWRUPMD	Power up mode	GO, DELAY
REGULAT	Regulatory compliance	NTEP, OIML, CANADA, NONE
CONSNUM	Consecutive number	0-999999
CONSTUP	Consecutive number start-up value	0-999999
ACCUM	Accumulator	ON/OFF
ACCUM.RTZGRADS	Return to zero trigger in grads	0-10000
DATEFMT	Date format	MMDDYY, DDMMYY, YYMMDD, YYDDMM
DATESEP	Date separator	SLASH, DASH, SEMI
TIMEFMT	Time format	12HOUR, 24HOUR
TIMESEP	Time separator	COLON, COMMA
UID	Unit ID Value	0-999999
POWER	Power switch mode	AUTO, MANUAL
SLEEP	Sleep mode setting	NEVER, 1, 2, 5, 10
STDBY	Standby setting	OFF, 1SEC, 2SEC, 3SEC, 5SEC, 10SEC, 60SEC
WGTHRH	Sleep Mode Weight Threshold	0-999999
DDTHRH	Sleep Mode Display Division Threshold	0-999999

Table 6-6. PROGRM EDP Commands

Command	Description	Values
DIGIN1 DIGIN2 DIGIN3 DIGIN4	Digital input function	OFF, ZERO, TARE, NT-GRS, UNITS, DSPTAR, PRINT, CLRCN, KBDLOC, HOLD, CLRTRAR, ACCUM, CLRACC, BATSTR, BATSTP, BATRES, BATPUS, BATRUN, NET, GROSS, PRI, SEC

Table 6-7. DIG IN EDP Commands

Command	Description	Values
DON DOFF	Digital Channel	Specify Channel

Table 6-8. DIG OUT Commands

Command	Description	Values
ALG.SOURCE	Analog output source	GROSS, NET
ALG.OFFSET	Zero offset	0%, 20%
ALG.ERRACT	Error action	FULLSC, HOLD, ZEROSC
ALG.MIN	Minimum value tracked	0-999999
ALG.MAX	Maximum value tracked	0-999999
ALG.MINNEG	Minimum negative	NO, YES
ALG.MAXNEG	Maximum negative	NO, YES
ALG.TWZERO	Zero calibration	0-65535
ALG.TWSPAN	Span calibration	0-65535
ALG.OUTPUT	Voltage or current output	CURRENT, VOLTAGE

Table 6-9. ALGOUT EDP Commands

Command (n = setpoint number)	Description	Values
SP.BATCHG	Batching	OFF, AUTO, MANUAL
SP.ENABLE#n	Setpoint enable	OFF, ON
SP.KIND#n	Setpoint kind	GROSS, NET, -GROSS, -NET, OFF, DELAY
SP.VALUE#n	Setpoint value	Number
SP.TRIP#n	Trip	HIGHER, LOWER
SP.PREACT#n	Band value	Number
SP.HYSTER#n	Hysteresis	Number
SP.PUSHPR#n	Perform print when setpoint is satisfied	OFF, ON
SP.PUSHAC#n	Updates accumulator and performs a print when setpoint is satisfied	OFF, ON
SP.PUSHTR#n	Perform Tare when setpoint is satisfied	OFF, ON
SP.DIGOUT#n	Digital outputs	NONE, 1-8
SP.BATSEQ#n	Batch type setpoint	OFF, ON
SP.WAITSS#n	Value must be stable	OFF, ON

Table 6-10. SETPNTS 1-8 EDP Commands

Command (p = port number)	Description	Values
EDP.TRIGER#p	EDP port trigger	Port 1 – COMAND, DEMAND, PRN, NONE Port 2 – NONE, PRN, STR-1, STR-2, STR-3, STR-4, STR-5
EDP.BAUD#p	EDP port baud rate	1200, 2400, 4800, 9600, 19200, 38400
EDP.BITS#p	EDP port data bits/parity	8NONE, 7EVEN, 7ODD
EDP.SBITS#p	EDP port stop bits	1STOP, 2STOP
EDP.TERMIN#p	EDP port termination character	CR/LF, CR
EDP.EOLDLY#p	EDP port end-of-line delay	0-255 (0.1-second intervals)
EDP.ECHO#p	EDP port echo	ON, OFF
EDP.PRMSG#p	Enable print message when a demand print is performed	OFF, ON
EDP.STRUR#p	Legal for Trade or industrial stream	STRLFT,STRIND
EDP.STREAM	Specifies the operating mode of the indicator, See Section 9.4 on page 66	NONE, LOCAL, REMOTE

Table 6-11. SERIAL EDP Commands

Ethernet Functionality

The Ethernet port works in COMMAND mode meaning that it is possible to send a EDP command to the indicator and receive a response from the indicator accordingly. It is not possible to print from the port.

Command	Description	Values
ETH.DHCP	Dynamic Host Configuration Protocol (DHCP)	ON – Dynamic allocation of IP address OFF – Static allocation of IP address
ETH.IPADDRESS	Source IP address, a 4 field value	The range of each field is 0-255 (0-255).(0-255).(0-255).(0-255)
ETH.NETMASK	SUBNET mask, a 4 field value	The range of each field is 0-255 (0-255).(0-255).(0-255).(0-255)
ETH.DEFAULTGATEWAY	Default gate way, a 4 field value	Range of each field is 0-255 (0-255).(0-255).(0-255).(0-255)
ETH.MAC	Returns the MAC address, read only	Six fields, 8-bit each, in hexadecimal base
ETH.SERVER.PORT	The ethernet server TCP port	1-65535
ETH.SERVER.ECHO	Sets the Server Port Echo	ON, OFF
ETH.SERVER.TRIGGER	Server Port Trigger	DEMAND, COMAND, STRLFT, STRIND
ETH.SERVER.TIMEOUT	Server Inactivity Timeout in seconds	0-65535
ETH.SERVER.TERMIN	Server Line Termination	CR or CR/LF
ETH.SERVER.SFMT	Server Stream Format	STR-1, STR-2, STR-3, STR-4, STR-5
ETH.SERVER.EOLDLY	Server End of Line Delay	0-255
ETH.CLIENT.REMOTESERVERIP	Client Remote Server IP Address	Range of each field is 0-255 (0-255).(0-255).(0-255).(0-255)
ETH.CLIENT.REMOTESERVERPORT	Client Remote Server TCP Port number	1-65535
ETH.CLIENT.TRIGGER	Client Port Trigger	DEMAND, COMAND, STRLFT, STRIND
ETH.CLIENT.TIMEOUT	Client Inactivity Timeout in seconds	0-65535
ETH.CLIENT.TERMIN	Client Line Termination	CR or CR/LF
ETH.CLIENT.SFMT	Client Stream Format	STR-1, STR-2, STR-3, STR-4, STR-5
ETH.CLIENT.EOLDLY	Client End of Line Delay	0-255
ETH.CLIENT.ECHO	Sets the Client Echo	ON, OFF

Table 6-12. Ethernet Commands

Command	Description	Default Values
GFMT	Gross demand print format string	GROSS<G><NL2><TD><NL>
NFMT	Net demand print format string	GROSS<G><NL>TARE<SP><T><NL>NET<SP2><N><NL2><TD><NL>
ACCFMT	Accumulator demand print format string	ACCUM <A><NL><DA> <TI><NL>
SPFMT	Setpoint print format	<SCV><SP><SPM><NL>

Table 6-13. PFORMT EDP Commands

Command	Description	Values
POWER	Determines if indicator automatically powers on when plugged in or if Power key must be pressed; read only in Weigh Mode	AUTO MANUAL
BKLGHT	Controls the LED backlight display; read only in Weigh Mode	ON, OFF, AUTO
BKLGHT.AUTO	Controls the LED backlight display auto off time; read only in Weigh Mode	10SEC, 30SEC, 1MIN, 5MIN, 10MIN
BAT	Reads the battery level; read only	Current battery level in millivolts
USB.DEVICE	Select the USB Device	HOST, DRIVE, PRINTER
USB.TRIGGER	Set the USB Port Trigger	DEMAND, COMAND

Table 6-14. MISC Commands

6.1.6 Normal Mode Commands

The serial transmit weight data commands, See [Table 6-15](#), transmit data to the selected port on demand. The SX and EX commands are valid only in weigh mode; all other commands are valid in either setup or weigh mode.

Command	Description	Response Format
UID	View and set unit ID when in setup mode; in Weigh mode, the value can be changed temporarily; it will revert to last saved value at next power up	<i>nnnnnn</i>
DATESET	View or set date	The response will be in the format as defined in configuration; to set, first query the date then send DATESET= , in exactly the same format (except use only two digits for the year)
TIMESET	View or set time	The response will be in the format as defined in configuration; to set, first query the time then send TIMESET= followed by the time in exactly the same format as the query, including seconds, and AM or PM if 12 hour
SX	Start streaming on Port 2 NOTE: The Trigger Mode of Port 2 must be set to one of the five stream modes for this command to function	OK or ??
EX	Stop streaming on Port 2 NOTE: The Trigger Mode of Port 2 must be set to one of the five stream modes for this command to function.	OK or ??
RS	Soft reboot	--
XA	Transmit accumulator value	<i>nnnnnn UU</i>
XG	Transmit gross weight in displayed units	Where <i>nnnnnn</i> is the weight value, <i>UU</i> is the units
XN	Transmit net weight in displayed units	
XT	Transmit tare weight in displayed units	
XG2	Transmit gross weight in non-displayed units	
XN2	Transmit net weight in non-displayed units	
XT2	Transmit tare weight in non-displayed units	
XE	Query system error conditions	<i>nnnnn nnnnn</i> See Section 9.0 on page 61 for detailed information about the XE command response format

Table 6-15. Normal Mode Commands

7.0 Print Formatting

The 480 provides multiple print formats, **GFMT**, **NFMT**, **ACCFMT** and **SPFMT**, that determine the format of the printed output when  is pressed. If a tare has been entered or acquired, **NFMT** is used; otherwise, **GFMT** is used.

Each print format can be customized to include up to 300 characters of information, such as company name and address, on printed tickets. Use the indicator front panel **PFORMT** menu to customize the print formats.



Note

The indicator displays capital letters. Press the down arrow to view the ASCII character decimal value on the second menu level. Refer to [Table 9-6 on page 73](#) and [Table 9-7 on page 74](#) to view the ASCII character charts.

7.1 Print Formatting Tokens

[Table 7-1](#) lists tokens that can be used to configure the print formats. Tokens included in the format strings must be enclosed between < and > delimiters. Characters outside of the delimiters are printed as text on the ticket. Text characters can include any ASCII character that can be printed by the output device.

Token	Description
<G>	Gross weight in displayed units
<G2>	Gross weight in non-displayed units ***
<N>	Net weight in displayed units
<N2>	Net weight in non-displayed units ***
<T>	Tare weight in displayed units
<T2>	Tare weight in non-displayed units ***
<A>	Accumulated weight in displayed units
<AC>	Number of accumulator events (five digit counter)
<AD>	Date of last accumulator event
<AT>	Time of last accumulator event
<UID>	Unit ID number
<CN>	Consecutive number
<NLnn>	New line (nn = number of termination (<CR/LF> or <CR>) characters)*
<SPnn>	Space (nn = number of spaces)*
<SU>	Toggle weight data format (formatted/unformatted) ** ***
<TI>	Time
<DA>	Date (prints four digit year)
<TD>	Time & Date
<SCV>	Setpoint captured value
<STV>	Setpoint target value
<SPM>	Setpoint mode (Net or Gross)
<SN>	Setpoint number
Gross, net and tare weights are nine digits in length, including sign (10 digits with decimal point), followed by a space and a two-digit units identifier; total field length with units identifier is 12 (or 13) characters	
UID and consecutive number (CN) fields are six characters in length	
* If nn is not specified, 1 is assumed; value must be in the range 1–99	
** After receiving an SU command, the indicator sends unformatted data until the next SU command is received; unformatted data omits decimal points, and leading and trailing characters	
*** Not available if regulatory mode is set to OIML	

Table 7-1. Print Format Tokens

The default 480 print formats, See [Table 7-2](#):

Format	Default Format String	When Used
GFMT	GROSS<G><NL2><TD><NL>	Weigh mode–no tare in system
NFMT	GROSS<G><NL>TARE<SP><T><NL>NET<SP2><N><NL2><TD><NL>	Weigh mode–tare in system
ACCFMT	ACCUM <A><NL><DA><SP><TI><NL>	Accumulator demand print format string
SPFMT	<SCV><SP><SPM><NL>	Setpoint print operation with PSHPRNT=ON

Table 7-2. GFMT and NFMT Formats



Note The <G2>, <N2> and <T2> tokens, See [Table 7-1 on page 58](#), print the gross, net and tare weights in the units not currently displayed on the indicator.

The 300 character limit of each print format string includes the output field length of the print formatting tokens, not the token length. For example, if the indicator is configured to display a decimal point, the <G> token generates an output field of 13 characters: the 10 character weight value (including decimal point), one space, and a two-digit units identifier.

PT (preset tare) is added to the tare weight if tare was keyed in.

7.2 Customizing Print Formats

The following sections describe procedures for customizing the **GFMT**, **NFMT**, **ACCFMT** and **SPFMT** formats using the front panel **PFORMAT** menu, See [Figure 7-1](#) for print format menu structure.

7.2.1 Using the Front Panel

Using the **PFORMAT** menu, edit the print format strings by changing the decimal values of the ASCII characters in the format string.



Note Some characters cannot be displayed on the 480 front panel, See [Section 9.15 on page 73](#) for the ASCII character charts. The 480 can send or receive ASCII characters; the character printed depends on the particular ASCII character set implemented for the receiving device.

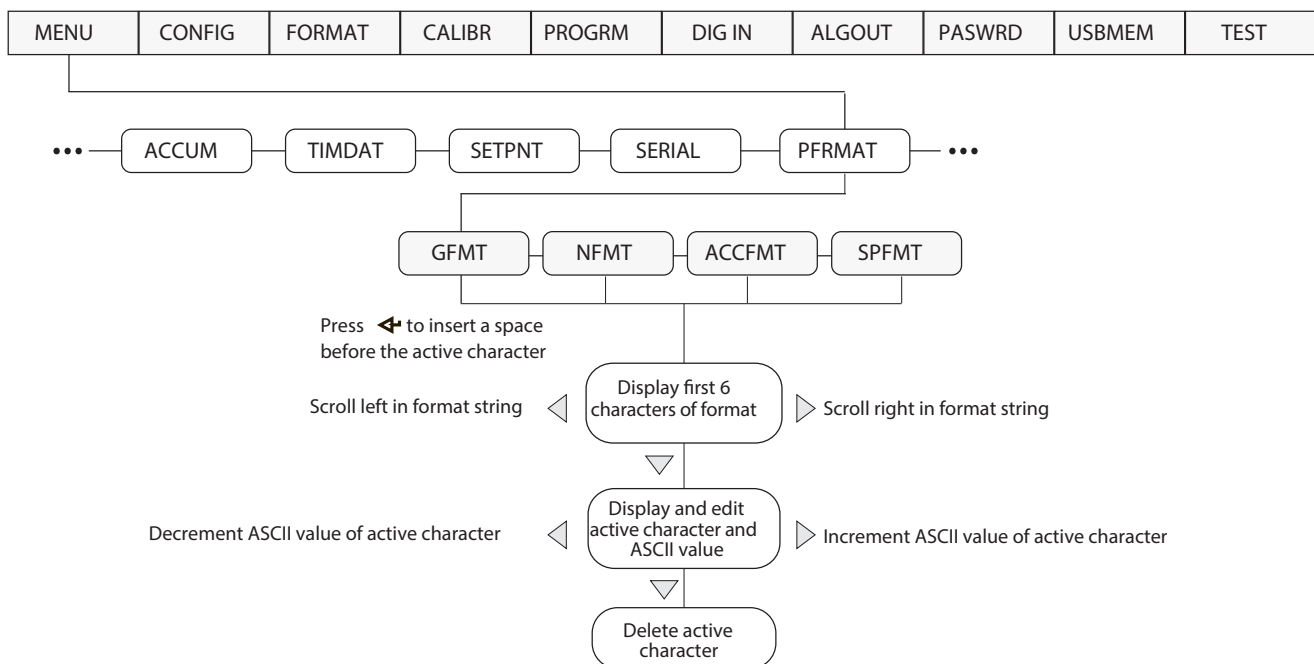

Figure 7-1. Print Format Menu

8.0 Setpoints

The 480 indicator provides eight configurable setpoints for control of both indicator and external equipment functions. Setpoints can be configured to perform actions or functions based on specified parameter conditions. Parameters associated with various setpoint kinds can, for example, be configured to perform functions (print, tare, accumulate), to change the state of a digital output controlling indicator or external equipment functions, or to make conditional decisions.



Note *Weight-based setpoints are tripped by values specified in primary units only.*

IMPORTANT

Firmware versions 1.00 and 1.01 require having a relay board installed for the setpoints to operate.

8.1 Batch and Continuous Setpoints

480 setpoints can be either continuous or batch.

Continuous setpoints are free-running; the indicator constantly monitors the condition of free-running setpoints at each A/D update. The specified setpoint action or function is performed when the designated setpoint parameter conditions are met. A digital output or function assigned to a free-running setpoint continuously changes state, becoming active or inactive, as defined by the setpoint parameters.

Batch setpoint (**BATSEQ = ON**) is a digital output associated with a batch setpoint is active until the setpoint condition is met; it is latched for the remainder of the batch sequence.

To use batch setpoints, set the batching (**BATCHG**) parameter on the setpoints (**SETPTS**) menu. This parameter defines whether a batch sequence is automatic or manual. Automatic sequences repeat continuously after receiving a single batch start signal, while manual sequences only run through once for each Batch Start signal. The batch start signal can be initiated by a digital input (set to **BATSTR**), or an EDP command (**BATSTART**).

For a setpoint to be used as part of a batch sequence, its batch sequence (**BATSEQ**) parameter must be set to **ON**. If a setpoint is defined and enabled, but its Batch Sequence parameter is set to **OFF**, the setpoint operates as a continuous setpoint even during batch sequences.



Note *In applications that contain both batch setpoint routines and continuous setpoints, it is good practice to keep continuous setpoints separate from the batch sequence.*

Do not assign them the same digital output.

9.0 Appendix

9.1 Error Messages

The 480 indicator provides a number of error messages. When an error occurs, the message prompts on the indicator LED display.

9.1.1 Displayed Error Messages

The 480 provides a number of front panel error messages to assist in problem diagnosis. [Table 9-1](#) lists these messages and their meanings.

Error Messages	Description	Solution
E A/D	A/D physical error	Call Rice Lake Weighing Systems Service at 800-472-6703
EEEROM	EEPROM physical error	
EVIREE	Virgin EEPROM	Use TEST menu to perform DEFLT (restore defaults) procedure then recalibrate load cells
EPCKSM	Parameter checksum error	
EACKSM	A/D calibration checksum error	A/D converter requires recalibration. Call Rice Lake Weighing Systems Service
EFCKSM	Printer format checksum error	Call Rice Lake Weighing Systems Service at 800-472-6703
ELCKSM	Load cell calibration checksum error	Recalibrate load cells
EIDATA	Internal RAM checksum error	Call Rice Lake Weighing Systems Service at 800-472-6703
E REF	A/D reference error	A/D converter requires recalibration; call Rice Lake Weighing Systems Service
ERROR	Internal program error	Check configuration; call Rice Lake Weighing Systems Service if unable to clear error by cycling power or if error recurs
OVERFL	Overflow error	Weight value is too large to be displayed
=====	Gross > overload limit	Gross value exceeds overload limit; check configuration or signal input level; overload can be caused by input signal > 45 mV or common mode voltage > 950 mV
-----	Gross < 20d behind zero	Gross value is more than 20 divisions behind zero (OIML)
RNGERR	GRADS > 100,000 WVAL > 100,000	Only displays in configuration mode
EEPERR	EEPROM error	Call Rice Lake Weighing Systems for service at 800-472-6703
HINOFF	High offset	Zero load at startup is more than initial zero range (INIZR) setting of calibration zero—remove the extra load
LINOFF	Low offset	Zero load at startup is less than initial zero range (INIZR) setting of calibration zero—add the missing load
NOBATT	No battery	The RTC lost time/date tracking at previous power off state due to low battery or no battery condition; the printer, accumulator and audit functions will fail to get time and date NOTE: Refers to internal coin battery only, not the rechargeable battery option.
EUCKSM	Configuration checksum	The checksum value of configuration has changed from that stored in memory
OIMLER	OIML parameter error	Parameter set incorrectly for use in the OIML mode; <i>Example: Primary units set for lb or oz</i>
EE-ACC	Accumulator error	Error with the accumulator such as attempting to display an accumulated value greater than six digits

Table 9-1. 480 Error Messages



Note Shorting the excitation voltage shuts the excitation voltage off. The only way to restore excitation voltage is to cycle power.

9.1.2 XE EDP Command

The XE EDP command can be used to remotely query the 480 for the error conditions displayed on the front panel.

The XE command returns two five digit numbers in the format:

Example: xxxxx yyyyy

Where **xxxxx** contains a decimal representation of an existing error conditions as described in [Table 9-2](#).

If more than one error condition exists, the number returned is the sum of the values representing the error conditions. For example, if the XE command returns the number 1040, this value represents the sum of an A/D reference error (1024) and an A/D calibration checksum error (16).

The second number returned (**yyyyy**) uses bit assignments to indicate whether the test for the error condition is run, See [Table 9-2](#) for error condition information.

Example: the value yyyyy = 50815 represents the decimal equivalent of the binary value 1100 0110 0111 1111.

Using the bit assignments in [Table 9-2](#), this value indicates all tests were run.

Error Code	Description	Binary Value
1	EEPROM Error	0000 0000 0000 0001
2	Virgin EEPROM	0000 0000 0000 0010
4	Config Parameter Checksum	0000 0000 0000 0100
8	Load Cell Checksum	0000 0000 0000 1000
16	A/D Calibration Checksum	0000 0000 0001 0000
32	Print Formats Checksum	0000 0000 0010 0000
64	XA Internal RAM Error	0000 0000 0100 0000
128	External RAM Error	0000 0000 1000 0000
256	Reserved	0000 0001 0000 0000
512	ADC Physical Error	0000 0010 0000 0000
1024	ADC Reference	0000 0100 0000 0000
2048	Count Error	0000 1000 0000 0000
4096	Reserved	0001 0000 0000 0000
8192	Display Range	0010 0000 0000 0000
16384	ADC Range	0100 0000 0000 0000
32768	Gross Limit	1000 0000 0000 0000
0x10000 - 0x80000000		Reserved

Table 9-2. Error Codes Returned on XE Command

9.2 Status Messages

Two EDP commands, P and ZZ can be used to provide status about the indicator. These commands are described in the following sections.

9.2.1 P EDP Command

The P EDP command returns the current displayed weight value, along with the units identifier. If the indicator is in an underrange or overload condition, the weight value is replaced with &&&&&& (overload) or ::::: (underrange).

9.2.2 ZZ EDP Command

The ZZ EDP command can be used to remotely query which annunciators are currently displayed on the indicator front panel. The ZZ command returns the currently displayed weight and a decimal number representing the annunciators currently lit. The format of the returned data is:

Example: `wwwwww uu zzz`

Where **wwwwww uu** is the currently displayed weight and units, and **zzz** is the annunciator status value, See [Table 9-3](#). If more than one annunciator is lit, **ZZZ** is the sum of the values representing the active annunciators.

Example: If the annunciator status value returned on the ZZ command is 145, the gross, standstill and lb annunciators are lit. The number 145 represents the sum of the values for the standstill annunciator (128), gross mode annunciator (16) and the lb/primary units annunciator (1).

Decimal Value	Annunciator
1	lb/primary units
2	kg/secondary units
4	Tare entered
8	Keyed tare entered
16	Gross
32	Net
64	Center of zero
128	Standstill

Table 9-3. Status Codes Returned on the ZZ Command

9.3 Continuous Data (Stream) Output Formats

When the trigger setting for COM-2 is set to one of the stream formats (STR1-STR5), or the Ethernet client or server trigger setting is STRLFT or STRIND, data is continuously streamed from the appropriate port in one of the five fixed formats that follow.

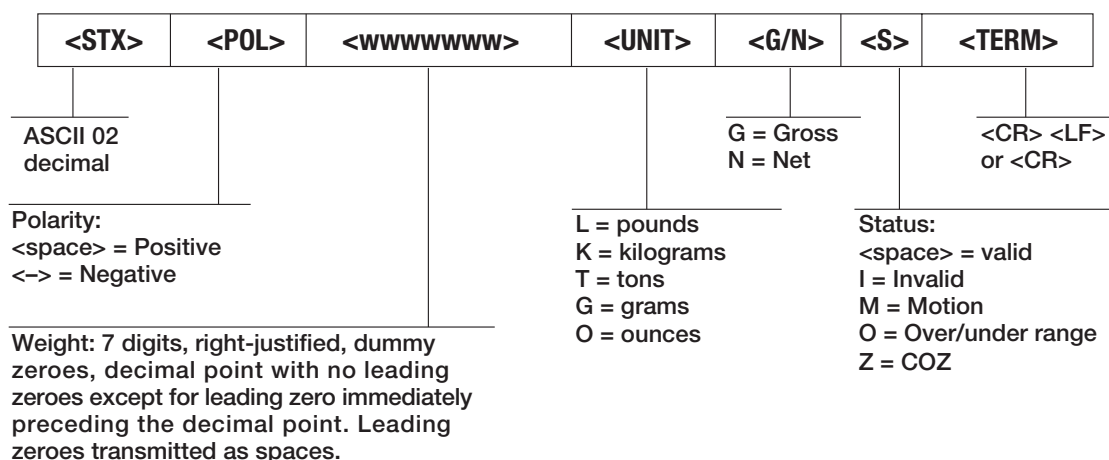
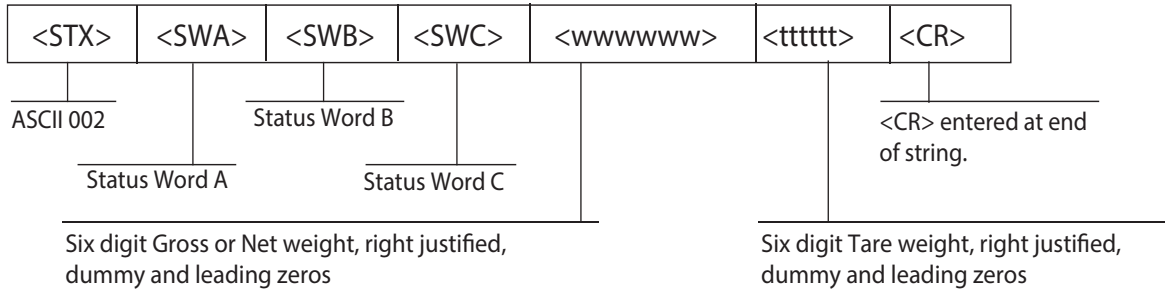

Figure 9-1. STR-1 Rice Lake Stream Data Format



Note Set format 5 if receiving device cannot read a status bit Z.



Status Word A:

7	6	5	4	3	2	1	0
Parity	0	1	MUL1	MUL0	DP2	DP1	DP0

	Even parity bit. Requires EDP Port setup.		DP2 DP1 DP0 Fixed Zero/Dec. Pt. Location
			0 0 0 x 100 (2 fixed zeroes)
			0 0 1 x 10 (1 fixed zero)
			0 1 0 x 1 (No decimal point)
Disp. Div.			0 1 1 x 0.1 (1 decimal place)
MUL1 MUL0 Multiplier			1 0 0 x 0.01 (2 decimal places)
0 1 x 1			1 0 1 x 0.001 (3 decimal places)
1 0 x 2			1 1 0 x 0.0001 (4 decimal places)
1 1 x 5			1 1 1 x 0.00001 (5 decimal places)

Status Word C: ASCII 20h (space)

7	6	5	4	3	2	1	0
Parity	0	1	0	0	0	0	0

Even parity bit:
Requires EDP Port setup.

Status Word B:

7	6	5	4	3	2	1	0
Parity	0	1					

	Even parity bit: Requires EDP Port setup.		0 = lb 1 = kg		0 = Stable 1 = Motion		0 = Gross Display Mode 1 = Net Display Mode
							0 = Positive indicated weight value 1 = Negative indicated weight value
							0 = In range 1 = Out of range

Figure 9-2. STR-2 Toledo Stream Data Format

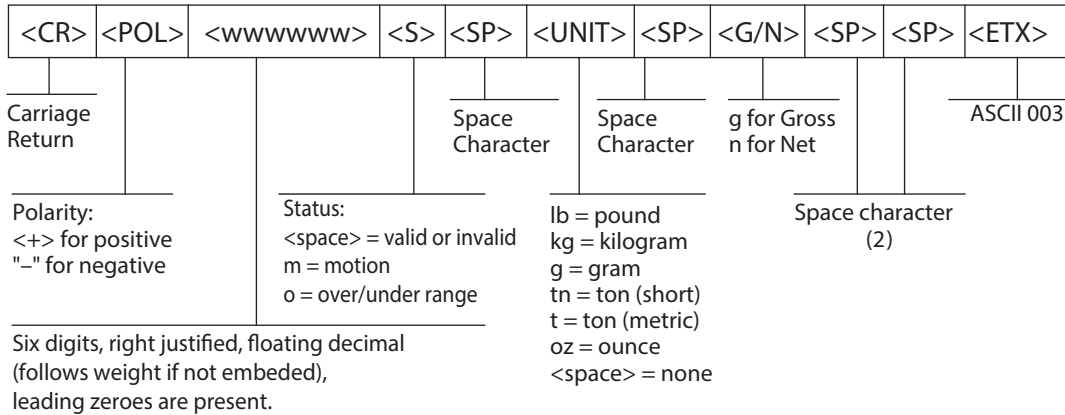

Figure 9-3. STR-3: Weightronix Stream Data Format

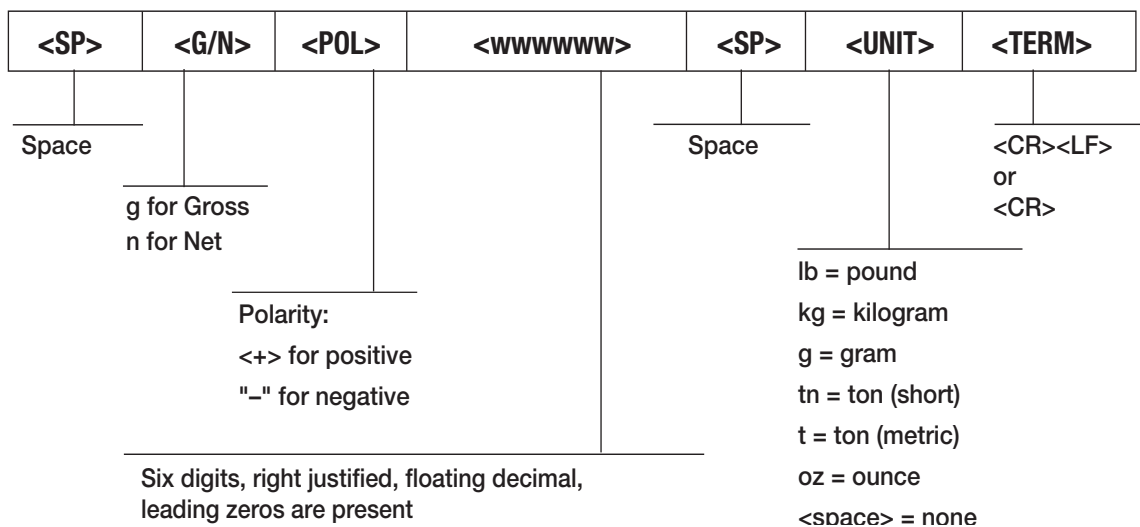

Figure 9-4. STR-4 Cardinal Stream Data Format

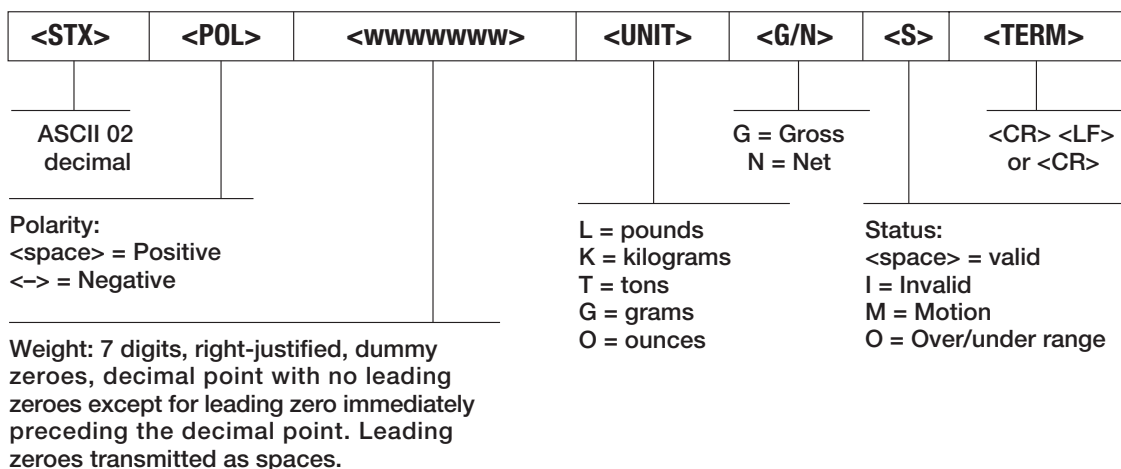

Figure 9-5. STR-5: Consolidated Controls Stream Data Format



Note Port 1 cannot be set to stream.

9.4 Local/Remote Operation

For systems that require two locations, local/remote support provides function equivalent to that of a Legal for Trade remote display with keypad. Scale data from the local indicator is also displayed at the remote unit and keypad input from the remote allows transactions to be initiated from either the local or remote unit.

To configure for local/remote operation, set STREAM to local or remote. Once the local unit scale has been configured, use the SERIAL menu, serial commands or Revolution to set the serial parameters for local/remote operation, See [Table 3-3 on page 28](#) for comport options.

Serial Configuration Parameter	Local Unit		Remote Unit	
	Parameter Value	Function	Parameter Value	Function
STREAM	Local	Stream Continuous Data	Remote	Sets indicator to display the weight data sent from the Local Unit
COM2.TRIGGER	Select STR-1	Streams the local unit weight data to the remote unit	Select STR-1	Transmits demand key presses, zero, gross/net, tare, units
COM2.BAUD	Local and remote must match			
COM2.ECHO	OFF	--	OFF	--

Table 9-4. Local/Remote Configuration

Printing operation can be performed at the remote unit and/or at the local unit. When the operator presses the **Print** key at the local unit, a printing ticket will be issued only locally. When the operator presses the **Print** key at the remote unit, print will only occur at the remote unit.

9.5 Audit Trail Support

Audit trail support provides tracking information for configuration and calibration events. To prevent potential misuse, all configuration and calibration changes are counted as change events.

Audit trail information can be printed from Revolution or by sending the DUMPAUDIT serial command, See [Figure 3-1 on page 24](#). Revolution can be used to display audit trail information. The audit trail display includes the legally relevant (LR) version number (firmware version for the code that provides audit trail information), a calibration count and, if REGULA=NTEP or Canada, a configuration count. The exact format of the information depends on the regulatory agency specified for the REGULA (PROGRM menu) parameter.

See [Section 1.8.9 on page 8](#) to view the Audit Trail.

For NTEP and Measurement Canada modes, there are two numbers displayed: Configuration and Calibration. The Configuration number tracks changes to the legally relevant configuration parameter changes. The Calibration number tracks changes to the scale calibration.

In OIML mode, there is only one number displayed; Audit Trail. The Audit trail number is incremental for a legally relevant configuration parameter changes and all calibration changes. The last date the scale was calibrated is also displayed.

9.6 Sleep Mode

Firmware version 1.03 and newer of the 480 features a **SLEEP** mode. It is designed to place the indicators into a low power mode to reduce power consumption.

The sleep mode will only activate if the indicator is operating on its internal optional battery. If connected to external AC power, the indicator will not go into sleep mode regardless of the parameter settings.

The indicator will enter the sleep mode, after the time specified in the **SLEEP** parameter, when no keypad activity is detected and the displayed weight is below the weight threshold (**WGTHR**). Setting the sleep parameter to never disables the sleep mode.

9.6.1 Standby

While in **SLEEP** mode, at a time specified in the standby (**STDBY**) parameter, the indicator wakes up for about 0.5 seconds. The range of the standby time is 1 to 60 seconds. During the awake time, it checks for a change in weight greater than the display division threshold (**DDTHR**), or if the weight has gone above the weight threshold (**WGTHR**). It also checks to see if a key is being pressed, and it performs zero tracking.

Example: If the standby parameter set to 1 second, the weight threshold to 100, and the display division threshold is set to 10d, once in sleep mode, the indicator will wake up every second for about half a second to check to see if a key is being pressed, the weight threshold is over 100 (WGTHR), or the weight has change more than 10d (DDTHR) since the last time it checked.

Setting the standby parameter to a higher value reduces the amount of time the indicator is awake, this will increase battery life.

An **OFF** setting stops the indicator from waking up. The only way to wake up the indicator is to press the **Power** key.



Note

The Power key is the only key that will wake the indicator, unless the Standby parameter is set to another setting other than NONE then press a key to wake the indicator from standby.

9.7 Internal Battery Option

In Firmware version 1.03 and later, an optional internal rechargeable Li-ion battery is available. The battery can replace the AC power when needed. Typical run time is 12 hours (single load cell, no options, with LED display). The amount of time the indicator will operate on the battery depends on:

- Type of display (LED)
- If sleep mode is used or not
- How many load cells are attached
- What options are installed

The battery is automatically charged when the indicator is connected to AC power. It automatically switches to battery power if the AC power is removed. The battery is designed to only be charged by connecting to AC power.

When operating on battery power, the indicator features a **SLEEP** mode that allows the indicator to go into a low power mode. Using the **SLEEP** mode helps improve battery life, See [Section 9.6 on page 66](#) for more information about the **SLEEP** mode.

When the battery life reaches 5-10 percent of capacity, the **Lo Bat** flashes on the display. When the battery life is less than 5%, it will flash faster, at 0%, the indicator will turn off. Battery charge time is approximately 16 hours to 100%.

9.8 USB Option

In firmware version 1.03 and later, an optional Ethernet/USB board is supported.

The USB connection is capable of being one of the following:

- USB device (connected to a PC and is an available communication port)
- USB host interface to a flash DRIVE
- USB interface to printer

The mode of the USB option is selected in the User menu.

9.8.1 HOST

When set to HOST mode, the USB port can be connected to a USB connection on a PC. An HCC Driver is required on the PC. The HCC driver is available on a CD (PN 171153) that is included with the USB/Ethernet Option.

Use the documentation (PN 171152) for the option to install the driver on the PC.

When connected to a PC, the connection is available to applications as another serial communications port. Using the USB trigger parameter in the 480 user menu, it is possible to set the port to act as both a serial command port and demand print port (**DEMAND**), or as a serial command port only (**COMAND**). All EDP serial commands can be used through the USB HOSTPC port. The USB port cannot be used to stream data.

9.8.2 Flash Drive

When set to **DRIVE** mode, the USB port can be connected to a flash drive to allow the upload and download of the indicator configuration parameters. The data is written to the drive in a FAT32 system format and no special drivers are required.

To use with a flash drive, first configure the **USB** parameter in the user menu to **DRIVE**. Saving the configuration to the drive, or loading it from the drive, can only be done in the configuration menu.

Save the Configuration

1. Attach a flash drive to the USB port.
2. Enter the configuration menu and navigate go to **USBMEM**, See [Section 3.2 on page 34](#).
3. Press ∇ then press \triangleleft or \triangleright to select **SAVE**, See [Section 3.2.9 on page 44](#).
4. Press the **Tare** key. A copy of the configuration DUMPALL, will be written to the drive in an ASCII text file with the name "480_<UID>.txt", where <UID> is replaced with the unit ID configured in the indicator.

Load a Configuration File

1. Install the file on the flash drive. The file can be either of two formats, a configuration dumpall text file, or a configuration file created by the Revolution indicator configuration utility. The file name must be 480_<UID>.txt for a text file or 480_<UID>.rev for a Revolution file, where <UID> is the currently configured Unit ID of the indicator.
2. Attach the flash drive to the USB port.
3. Enter the configuration menu and navigate go to **USBMEM**, See [Section 3.2 on page 34](#).
4. Press ∇ then press \triangleleft or \triangleright to select **LOAD**, See [Section 3.2.9 on page 44](#)
5. Press the **Tare** key. If a file is found on the flash drive with a <UID> that matches that currently in the indicator, it will be loaded. If the loading of the file fails, an error will be displayed.

Edit and Save File on Flash Drive with Revolution

1. To open the file, select the appropriate 480 module and open it.
2. Use the import function in the file menu to import the configuration parameters into Revolution.

9.8.3 USB Printing

When set to **PRINTR** mode, the USB port can be connected to a USB printer using an appropriate USB cable.

To configure, See [Section 3.1.4 on page 31](#):

1. Set the USB port to **PRINTR**.
2. Set the trigger to **DEMAND**.
3. Press the **Print** key or call a remote print command to print to the USB printer.

9.9 Ethernet Option

In firmware version 1.03 and later, an optional Ethernet/USB board is supported.

With the Ethernet option installed, the 480 can either be connected directly to a PC via the Ethernet connection, or to an Ethernet network.

The 480 Ethernet option will support two simultaneous connections, one as a server, the other a client. It can be set up with a static, or DHCP-provided IP address. Both ports can be used to communicate to the indicator using all the available serial EDP commands. Both ports can be set to print on demand and can stream data.

The server port has a configurable TCP port number, and can accept a single remote client connection.

The client port can be configured to connect to a remote server's IP and TCP port number upon power up, or whenever there is data to send.

Connection is made via a RJ45 connector inside the indicator on the Ethernet/USB option board.

For details on all the configurable parameters for the optional Ethernet ports, See [Section 3.1.3 on page 30](#).

9.10 Conversion Factors for Secondary Units

The 480 has the capability to mathematically convert a weight into many different types of units and instantly display those results with a press of the **Unit** key.

Secondary units can be specified on the **FORMAT** menu using the **SECNDR** parameter.



Note

Multipliers are preconfigured within the indicator.

Ensure that the secondary decimal point position is set appropriately for the scale capacity in the secondary units. If the converted value requires more digits than are available, the indicator will display an overflow message (OVERFL).

For example, if the primary units are short tons, secondary units are pounds, and the secondary decimal point is set to 8888.88, the indicator will overflow if five tons or more are applied to the scale. With 5 tons applied, and a conversion factor of 2000, the secondary units display needs five digits to the left of the decimal point to display the 10000 lb secondary units value.

9.11 Digital Filtering (DIGFIL)

Digital filtering is used to create a stable scale reading in challenging environments. The 480 (firmware version 1.03 and later) allows selection of **Adaptive Filtering**, See [Section 9.11.2](#), **Rolling Filtering**, See [Section 9.11.3 on page 70](#) or **OFF** for no filtering.

The A/D sample rate must be selected first, See [Section 9.11.1](#). Select the type of digital filter using **DIGFIL** parameter.

9.11.1 Sample Rate (SMPRAT)

The number of weight readings the indicator takes per second is A/D sample rate (**SMPRAT**).

The A/D sample rate can be 5, 10, 20, or 40 Hz or readings per second.

Set the A/D sample rate to the lowest setting required for the application. Lower settings result in better stability. Better stability ensures that 5 Hz is more stable than 40 Hz.

9.11.2 Adaptive Filter

The Adaptive Filter has two settings, Sensitivity (**AFSENS**) and Threshold (**AFTHR**). It maintains a running average of the A/D readings when the weight change remains less than the defined Threshold value. The filter automatically applies less value to each successive A/D reading the longer the weight change is less than the Threshold value. The amount of value given to the most recent A/D reading is determined by the sensitivity setting.

Adaptive Filter Sensitivity (AFSENS)

Adaptive filter sensitivity (**AFSENS**) can be set to **HEAVY**, **MEDIUM** or **LIGHT**. A heavy setting will result in an output that is more stable to weight changes, than that of light. However, small changes in weight data (a few grads) on the scale base will not be seen as quickly.

If the difference in typical subsequent weight values on the scale will only be a few grads, use a light setting. On a truck scale where the changes in subsequent weight values will be 100s of grads, a heavy setting will be more appropriate. When the weight has not exceeded the Threshold (**AFTHR**) setting, the effective response is approximately 30 A/D cycles for **LIGHT**, 90 A/D cycles for **MEDIUM** and 180 A/D cycles for **HEAVY**.

Adaptive Filter Threshold (AFTHR)

The adaptive filtering threshold (**AFTHR**) should be set for the amount of observed instability in the system. This parameter can be set in the range of 0 to 99999 and is entered as a weight value. When a new sampled weight value is acquired, the adaptive filter compares the new value to the previous (filtered) output value.

If the difference between the new value and the previous output value is greater than the **AFTHR** parameter the adaptive filter is reset to the new weight value.

If the difference between the new value and the previous output value is less than the **AFTHR** parameter, the two values are averaged together using a weighted average. The weighted average is based on the amount of time the system has been stable, and selected **AFSENS** sensitivity.

With the adaptive filter threshold set at zero, determine the amount of instability that is present. Enter this amount of weight instability to set the threshold of the adaptive filter. The adaptive filter is set to **OFF** the **AFTHR** parameter is set to zero.

9.11.3 Rolling Averaging Filter

The Rolling Averaging Filter uses mathematical averaging with three stages. These configurable stages control the effect of a single A/D reading on the displayed weight. When an A/D reading is encountered that is outside a predetermined band, the rolling averaging filter is overridden, and the display jumps directly to the new value.

Filter Stages (RFSTG1-3)

The filter stages can each be set to a value of 1–64. The value assigned to each stage sets the number of readings received from the preceding filter stage before averaging. Setting the filter stages to 1 effectively disables the rolling filter.

A rolling average is passed to successive filtering stages for an overall filtering effect that is effectively a weighted average of the product of the values assigned to the filter stages ($RFSTG1 \times RFSTG2 \times RFSTG3$) within a time frame corresponding to the sum of the values ($RFSTG1 + RFSTG2 + RFSTG3$).

Filter Sensitivity (RFSENS) and Threshold (RFTHR)

The Rolling Averaging Filter can be used by itself to eliminate vibration effects, but heavy filtering also increases settling time. The **RFSENS** and **RFTHR** parameters can be used to temporarily override filter averaging and improve settling time.

- **RFSENS** specifies the number of consecutive A/D readings that must fall outside the filter threshold (**RFTHR**) before filtering is suspended
- **RFTHR** sets a threshold value, in display divisions; when the specified number of consecutive A/D readings (**RFSENS**) fall outside of this threshold, filtering is suspended; set **RFTHR** to **NONE** to turn off the filter override

Rolling Averaging Filter Parameters

1. In setup mode, set the rolling filter stage parameters (**RFSTG1-3**) to 1.
2. Set **RFTHR** to **NONE**.
3. Return to weigh mode.
4. Remove all weight from the scale then watch the indicator to determine the magnitude of vibration effects on the scale.
5. Record the weight below which all but a few readings fall. This value is used to calculate the **RFTHR** parameter in [Step 8](#).
Example: If a heavy-capacity scale (10000x5 lb) produces vibration-related readings of up to 50 lb, with occasional spikes to 75 lb, record 50 lb as the threshold weight value.
6. Place the indicator in setup mode and set the filter stage parameters (**RFSTG1-3**) to eliminate the vibration effects on the scale (leave **RFTHR** set to **NONE**).
7. Find the lowest effective value for the **RFSTG1-3** parameters.

If needed, the Rolling Filter Cutout Sensitivity (**RFSENS**) and the Rolling Filter Cutout Threshold (**RFTHR**) can be used to reset the averaging filter; the response to a rate change is faster.

8. Calculate the **RFTHR** parameter value by converting the weight value recorded in [Step 5](#) to display divisions ($\text{Threshold_Weight_Value} / \text{Display_Divisions}$).
In the example in [Step 5](#), with a threshold value of 50 lb, and a display divisions value of 5 lb, **RFTHR** should be set to 10 display divisions.
9. Set the **RFSENS** parameter high enough to ignore transient peaks. Longer transients (typically caused by lower vibration frequencies) will cause more consecutive out-of-band readings. **RFSENS** should be set higher to counter low frequency transients.

9.12 Analog Output Calibration

The following calibration procedure requires a multimeter to measure voltage or current output from the analog output module, See [Figure 3-15 on page 43](#) for analog output menu structure.



Note

The analog output must be calibrated after the indicator itself has been configured, See [Section 3.0 on page 22](#), and for calibration, See [Section 4.0 on page 46](#).

1. Enter configuration mode and go to the **ALGOUT** menu, See [Figure 3-15 on page 43](#).
 - Set source to GROSS or **NET**, depending on the weight value to be tracked by the analog output
 - Set **OFFSET** to 0% for 0–10V/0–20mA output, 20% for 2–10V/4–20 mA output
 - Set **MIN** to lowest weight value to be tracked by the analog output
 - Set **MAX** to highest weight value to be tracked by the analog output



Note

Calibrate the minimum weight value for 0 mA, even if a 4–20 mA output will be used. After the calibration is complete, select the 20% offset.

If set to a 20% offset, the lowest value tracked will be 4 mA. To use a value lower than 4mA, use the 0–20 mA setting.

2. Connect multimeter to analog output:
 - For voltage output, connect voltmeter leads to pins three and four
 - For current output, connect ammeter leads to pins one and two
3. Adjust zero calibration: Scroll to the **TWZERO** parameter. Check voltage or current reading on multimeter. Press ◀ or ▶ to select the digit to edit and ▲ or ▼ to adjust the value of selected (flashing) digit to set the zero value.
4. Adjust span calibration: Scroll to the **TWSPAN** parameter. Check voltage or current reading on multimeter. Press ◀ or ▶ to select the digit to edit and ▲ or ▼ to adjust the value of selected (flashing) digit to set the span value.
5. Final zero calibration: Return to the **TWZERO** parameter and verify that the zero calibration has not drifted. Press ◀ or ▶ to select the digit to edit and ▲ or ▼ to adjust the value of selected (flashing) digit to set the zero value.
6. Return to weigh mode. Analog output function can be verified using test weights.

9.13 Test Mode

In addition to weigh and setup modes, test mode provides a number of diagnostic functions for the 480, including:

- Display raw A/D count
 - Reset configuration parameters to default values
 - Number of weighments over threshold
 - View the state of the digital inputs
 - Control the state of the digital outputs
 - Test the analog output
1. Enter configuration mode by removing the setup switch access screw from the back of the enclosure.
 2. Insert a non-conductive tool into the access hole to press the configuration switch. Indicator display changes to **CONFIG**.
 3. Navigate to **TEST** and then down into the **TEST** menu.

[Figure 3-18 on page 45](#) provides the Test Menu structure and [Table 3-19 on page 45](#) summarizes the test menu functions.

9.14 Regulatory Mode Functions

Regulatory Parameter	Weight On Scale	Tare In System	Front Panel Key Tare	Front Panel Key Zero
NTEP	Zero	No	"000000"	Zero
		Yes	Clear Tare	Zero
	Negative	No	No Action	Zero
		Yes	Clear Tare	Zero
	Positive	No	Tare	Zero
		Yes	Tare	Zero
Canada	Zero	No	"000000"	Zero
		Yes	Clear Tare	Clear Tare
	Negative	No	No Action	Zero
		Yes	Clear Tare	Clear Tare
	Positive	No	Tare	Zero
		Yes	No Action	Clear Tare
OIML	Zero	No	"000000"	Zero
		Yes	Clear tare	Zero & Clear Tare
	Negative	No	No Action	Zero
		Yes	Clear Tare	Zero & Clear Tare
	Positive	No	"000000"	Zero
		Yes	Tare	Zero & Clear Tare
None	Zero	No	"000000"	Zero
		Yes	Clear Tare	Clear Tare
	Negative	No	No Action	Zero
		Yes	Clear Tare	Clear Tare
	Positive	No	Tare	Zero
		Yes	Clear Tare	Clear Tare

Table 9-5. Tare and Zero Key Functions for REGULA Parameter Settings



Note At zero weight push-button tare will prompt for a keyed tare when the tare function is set to keyed or both.

9.15 ASCII Character Chart

Use the decimal values for ASCII characters listed in [Table 9-6](#) and [Table 9-7](#) on page 74 when specifying print format strings on the 480 PFORMT menu. The actual character printed depends on the character mapping used by the output device.

The 480 can send or receive a ASCII character value (decimal 0–255), but the indicator display is limited to numbers, upper-case, unaccented letters and a few special characters, See [Section 9.16](#) on page 75 for information about the 480 LED display.

Control	ASCII	Dec	Hex	ASCII	Dec	Hex	ASCII	Dec	Hex	ASCII	Dec	Hex
Ctrl-@	NUL	00	00	space	32	20	@	64	40	`	96	60
Ctrl-A	SOH	01	01	!	33	21	A	65	41	a	97	61
Ctrl-B	STX	02	02	"	34	22	B	66	42	b	98	62
Ctrl-C	ETX	03	03	#	35	23	C	67	43	c	99	63
Ctrl-D	EOT	04	04	\$	36	24	D	68	44	d	100	64
Ctrl-E	ENQ	05	05	%	37	25	E	69	45	e	101	65
Ctrl-F	ACK	06	06	&	38	26	F	70	46	f	102	66
Ctrl-G	BEL	07	07	'	39	27	G	71	47	g	103	67
Ctrl-H	BS	08	08	(40	28	H	72	48	h	104	68
Ctrl-I	HT	09	09)	41	29	I	73	49	i	105	69
Ctrl-J	LF	10	0A	*	42	2A	J	74	4A	j	106	6A
Ctrl-K	VT	11	0B	+	43	2B	K	75	4B	k	107	6B
Ctrl-L	FF	12	0C	,	44	2C	L	76	4C	l	108	6C
Ctrl-M	CR	13	0D	-	45	2D	M	77	4D	m	109	6D
Ctrl-N	SO	14	0E	.	46	2E	N	78	4E	n	110	6E
Ctrl-O	SI	15	0F	/	47	2F	O	79	4F	o	111	6F
Ctrl-P	DLE	16	10	0	48	30	P	80	50	p	112	70
Ctrl-Q	DC1	17	11	1	49	31	Q	81	51	q	113	71
Ctrl-R	DC2	18	12	2	50	32	R	82	52	r	114	72
Ctrl-S	DC3	19	13	3	51	33	S	83	53	s	115	73
Ctrl-T	DC4	20	14	4	52	34	T	84	54	t	116	74
Ctrl-U	NAK	21	15	5	53	35	U	85	55	u	117	75
Ctrl-V	SYN	22	16	6	54	36	V	86	56	v	118	76
Ctrl-W	ETB	23	17	7	55	37	W	87	57	w	119	77
Ctrl-X	CAN	24	18	8	56	38	X	88	58	x	120	78
Ctrl-Y	EM	25	19	9	57	39	Y	89	59	y	121	79
Ctrl-Z	SUB	26	1A	:	58	3A	Z	90	5A	z	122	7A
Ctrl-[ESC	27	1B	;	59	3B	[91	5B	{	123	7B
Ctrl-\	FS	28	1C	<	60	3C	\	92	5C		124	7C
Ctrl-]	GS	29	1D	=	61	3D]	93	5D	}	125	7D
Ctrl-^	RS	30	1E	>	62	3E	^	94	5E	~	126	7E
Ctrl-_	US	31	1F	?	63	3F	_	95	5F	DEL	127	7F

Table 9-6. ASCII Character Chart (Part 1)

ASCII	Dec	Hex	ASCII	Dec	Hex	ASCII	Dec	Hex	ASCII	Dec	Hex
Ç	128	80	á	160	A0	--	192	C0	α	224	E0
ü	129	81	í	161	A1	--	193	C1	β	225	E1
é	130	82	ó	162	A2	--	194	C2	Γ	226	E2
â	131	83	ú	163	A3	--	195	C3	π	227	E3
ä	132	84	ñ	164	A4	--	196	C4	Σ	228	E4
à	133	85	Ñ	165	A5	--	197	C5	σ	229	E5
â	134	86	ª	166	A6	--	198	C6	μ	230	E6
ç	135	87	º	167	A7	--	199	C7	τ	231	E7
ê	136	88	¿	168	A8	--	200	C8	Φ	232	E8
ë	137	89		169	A9	--	201	C9	Θ	233	E9
è	138	8A	¬	170	AA	--	202	CA	Ω	234	EA
ï	139	8B	½	171	AB	--	203	CB	δ	235	EB
î	140	8C	¼	172	AC	--	204	CC	∞	236	EC
ì	141	8D	ì	173	AD	--	205	CD	φ	237	ED
Ä	142	8E	«	174	AE	--	206	CE	€	238	EE
Å	143	8F	»	175	AF	--	207	CF	∩	239	EF
É	144	90	--	176	B0	--	208	D0	≡	240	F0
æ	145	91	--	177	B1	--	209	D1	±	241	F1
Æ	146	92	--	178	B2	--	210	D2	≥	242	F2
ô	147	93	--	179	B3	--	211	D3	≤	243	F3
ö	148	94	--	180	B4	--	212	D4	∫	244	F4
ò	149	95	--	181	B5	--	213	D5	∫	245	F5
û	150	96	--	182	B6	--	214	D6	÷	246	F6
ù	151	97	--	183	B7	--	215	D7	≈	247	F7
ÿ	152	98	--	184	B8	--	216	D8	°	248	F8
Ö	153	99	--	185	B9	--	217	D9	•	249	F9
Ü	154	9A	--	186	BA	--	218	DA	--	250	FA
ç	155	9B	--	187	BB	--	219	DB	--	251	FB
£	156	9C	--	188	BC	--	220	DC	--	252	FC
¥	157	9D	--	189	BD	--	221	DD	²	253	FD
Pts	158	9E	--	190	BE	--	222	DE	--	254	FE
f	159	9F	--	191	BF	--	223	DF	--	255	FF

Table 9-7. ASCII Character Chart (Part 2)

9.16 Front Panel Display Characters

Figure 9-6 provides the seven-segment LED character set used to display alphanumeric characters on the 480 front panel.

	-	9	E	Q
	.	:	F	R
	/	;	G	S
	0	<	H	T
%	1	=	I	U
&	2	>	J	V
,	3	?	K	W
(4	@	L	X
)	5	A	M	Y
*	6	B	N	Z
+	7	C	O	[
,	8	D	P	\

Figure 9-6. Display Characters

9.17 Compliance

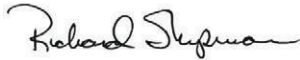
	EU DECLARATION OF CONFORMITY		Rice Lake Weighing Systems 230 West Coleman Street Rice Lake, Wisconsin 54868 United States of America
	<i>EU-KONFORMITÄTSEKTLÄRUNG DÉCLARATION UE DE CONFORMITÉ</i>		RICE LAKE WEIGHING SYSTEMS
Type/Typ/Type: 480 and 482 indicator			
English	We declare under our sole responsibility that the products to which this declaration refers to, is in conformity with the following standard(s) or other regulations document(s).		
Deutsch	Wir erklären unter unserer alleinigen Verantwortung, dass die Produkte auf die sich diese Erklärung bezieht, den folgenden Normen und Regulierungsbestimmungen entsprechen.		
Francais	Nous déclarons sous notre responsabilité que les produits auxquels se rapporte la présente déclaration, sont conformes à la/aux norme/s suivante ou au/aux document/s normatif/s suivant/s.		
EU Directive	Certificates	Standards Used / Notified Body Involvement	
2014/30/EU EMC	-	EN 55022:2010, EN 61000-3-2:2006+A1(09)+A2(09), EN 61000-3-3:2008, EN 55024:2010	
2014/35/EU LVD	-	EN 60950-1:2006+A11:2009+A1:2010+A12:2011+A2:2013	
2011/65/EU RoHS	-	EN 50581:2012	
Signature:		Place:	Rice Lake, WI USA
Type Name:	Richard Shipman	Date:	May 3, 2019
Title:	Quality Manager		

9.18 Specifications

Model Numbers

United States	480-2A/480 Plus-2A (NEMA Type 5-15)
International	480-2A/480 Plus-2A (CEE 7/7)

Power – AC

Line Voltages	100–240 VAC
Frequency	50 or 60 Hz
Power Consumption	70 mA @ 115 VAC (8 Ω) 35 mA @ 230 VAC (8 Ω)
Fusing	2.5 A 5 x 20 mm fuse

Power – Battery (Optional Internal Battery)

Battery Type:	Rechargeable Lithium-Ion
Nominal Voltage:	3.65v
Nominal Capacity:	5300mAh
Estimated Battery Life:	40 hours (350W load without backlight) 15 hours (350W load with backlight)
Approx. Charge Time:	16 hours to achieve 100%

Analog Specifications

Full Scale Input Signal	Up to 35 mV
Excitation Voltage	5 \pm 0.1 VDC
Sense Amplifier	Differential amplifier with Four- and Six-wire sensing
Analog Signal Input Range	Up to 7 mV/V
Analog Signal Sensitivity	0.1 μ V/graduation minimum 0.5 μ V/grad recommended
Local Resistance	35-1140 Ω
Noise (ref to input)	0.5 μ V p-p
Internal Resolution	523,376 counts
Display Resolution	100,000 dd
Measurement Rate	37 measurements/sec
Input Sensitivity	38 nV per internal count
System Linearity	Within 0.01% of full scale
Zero Stability	13 nV/ $^{\circ}$ C
Span Stability	13 ppm/ $^{\circ}$ C
Calibration Method	Software, constants stored in EEPROM
Common Mode Voltage	AGND + 250 mV V min Excitation - 250 mV V max
Rejection	120 dB minimum @ 50 or 60 Hz
Normal Mode Rejection	100 dB minimum @ 50 or 60 Hz
Input Overload	-0.3 V–(Excitation)+0.3 V
RFI Protection	Signal, excitation, and sense lines protected by capacitor bypass and ESD suppressors

Analog Output (Optional)

Type	Fully isolated, voltage or current output, 16-bit resolution
Voltage output	0–10 VDC
Voltage load resistance	1K Ω minimum
Current output	0–20 mA or 4–20 mA
Current loop resistance	1200 Ω ⁸ maximum

Digital Specifications

Microprocessor	ARM Cortex M3 STM32F103ZET6
Digital Filters	Adaptive Filter and Rolling Averaging Filter; software selectable

Digital I/O (Optional)

Type	Fully isolated
Digital Inputs	Two or four inputs, Opto isolated, 5–24 VDC input, active high
Digital Outputs	Four or eight dry-contact relays Up to 30VDC at 2A current

Serial Communications

Com 1	Full duplex RS-232
Com 2	Full duplex RS-232, or output only Active 20mA current loop
Both Ports	1200–38400 bps; seven or eight data bits; even, odd, or no parity; one or two stop bits



Note Only Com 2 can be set to stream.

Operator Interface

Display	Six-digit LED display. 7-segment, 0.8 in (20 mm) digits
Annunciators	Gross, net, center of zero, standstill, lb, kg, g, oz, t, pt
Keypad	Seven-key (19-key for Plus Model) flat membrane panel

Environmental

Operating Temperature	-10–+40°C (legal)
	-10–+50°C (industrial)
Storage Temperature	-25–+70°C
Humidity	0–95% relative humidity

Enclosure

Enclosure Dimensions	9.5 in x 6 in x 2.75 in
	24 cm x 15 cm x 7 cm
Weight	6 lb

Certifications and Approvals**NTEP**

CoC Number 12-123
Accuracy Class III/IIIL n_{max} : 10 000

**OIML R76/2006-NL1-15.24**

European Test Certificate TC8322
Accuracy Class III n_{max} : 10 000

Measurement Canada

Approval	AM-5892
Accuracy Class	III/IIHD n_{max} : 10 000

**UL**

File Number: 151461

LISTED

**FCC**

The 480 complies with Part 15 of the FCC Rules. Operation is subject to the following conditions:

- This device may not cause harmful interference.
- This device must accept any interference received, including interference that may cause undesired operation.

Warranty

2-year limited warranty



© Rice Lake Weighing Systems Content subject to change without notice.

230 W. Coleman St. • Rice Lake, WI 54868 • USA
U.S. 800-472-6703 • Canada/Mexico 800-321-6703 • International 715-234-9171 • Europe +31 (0)26 472 1319